

General Features

$V_{(BR)DSS}$	$R_{DS(on)MAX}$	I_D
60V	105mΩ@10V	3.0A
	125mΩ@4.5V	

Application

Load/Power Switching
Interfacing Switching
Battery Management for Ultra Small Portable
Logic Level Shift

Package and Pin Configuration

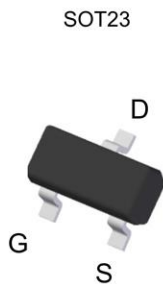

Circuit diagram

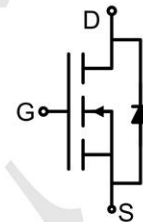

Marking:



Absolute Maximum Ratings ($T_A=25^{\circ}C$ unless otherwise noted)

Parameter	Symbol	Value	Unit
Drain-Source Voltage	V_{DS}	60	V
Gate-Source Voltage	V_{GS}	±20	V
Continuous Drain Current	I_D	3	A
Pulsed Drain Current (note 1)	I_{DM}	10	A
Power Dissipation	P_D	0.35	W
Thermal Resistance from Junction to Ambient (note 2)	$R_{\theta JA}$	357	$^{\circ}C/W$
Junction Temperature	T_J	150	$^{\circ}C$
Storage Temperature	T_{STG}	-55~+150	$^{\circ}C$

Electrical Characteristics ($T_A=25^\circ\text{C}$ unless otherwise noted)

Parameter	Symbol	Test Condition	Min	Typ	Max	Unit
STATIC CHARACTERISTICS						
Drain-source breakdown voltage	$V_{(BR)DSS}$	$V_{GS} = 0V, I_D = 250\mu A$	60			V
Zero gate voltage drain current	I_{DSS}	$V_{DS} = 60V, V_{GS} = 0V$			1	μA
Gate-body leakage current	I_{GSS}	$V_{GS} = \pm 20V, V_{DS} = 0V$			± 100	nA
Gate threshold voltage (note 3)	$V_{GS(th)}$	$V_{DS} = V_{GS}, I_D = 250\mu A$	0.5		2	V
Drain-source on-resistance (note 3)	$R_{DS(on)}$	$V_{GS} = 10V, I_D = 3A$			105	m Ω
		$V_{GS} = 4.5V, I_D = 3A$			125	m Ω
Forward transconductance (note 3)	g_{FS}	$V_{DS} = 15V, I_D = 2A$	1.4			S
Diode forward voltage (note 3)	V_{SD}	$I_S = 3A, V_{GS} = 0V$			1.2	V
DYNAMIC CHARACTERISTICS (note 4)						
Input Capacitance	C_{iss}	$V_{DS} = 30V, V_{GS} = 0V, f = 1MHz$		247		pF
Output Capacitance	C_{oss}			34		pF
Reverse Transfer Capacitance	C_{rss}			19.5		pF
SWITCHING CHARACTERISTICS (note 4)						
Turn-on delay time	$t_{d(on)}$	$V_{GS} = 10V, V_{DD} = 30V, I_D = 1.5A, R_{GEN} = 1\Omega$		6		ns
Turn-on rise time	t_r			15		ns
Turn-off delay time	$t_{d(off)}$			15		ns
Turn-off fall time	t_f			10		ns
Total Gate Charge	Q_g	$V_{DS} = 30V, V_{GS} = 4.5V, I_D = 3A$		6		nC
Gate-Source Charge	Q_{gs}			1		nC
Gate-Drain Charge	Q_{gd}			1.3		nC

Typical Electrical and Thermal Characteristics (Curves)

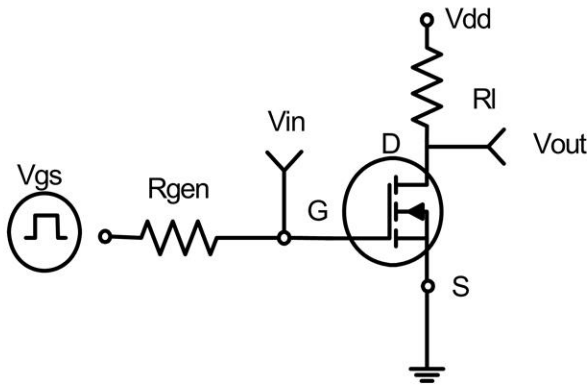

Figure 1: Switching Test Circuit

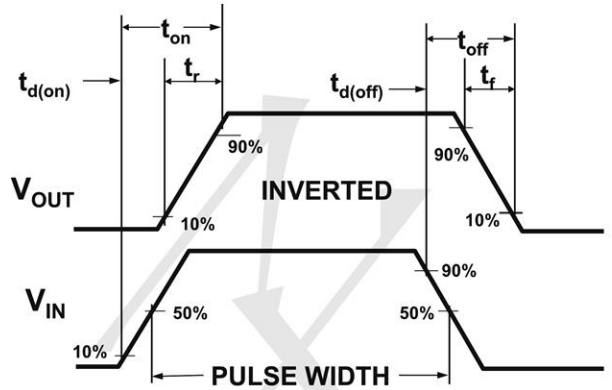

Figure 2: Switching Waveforms

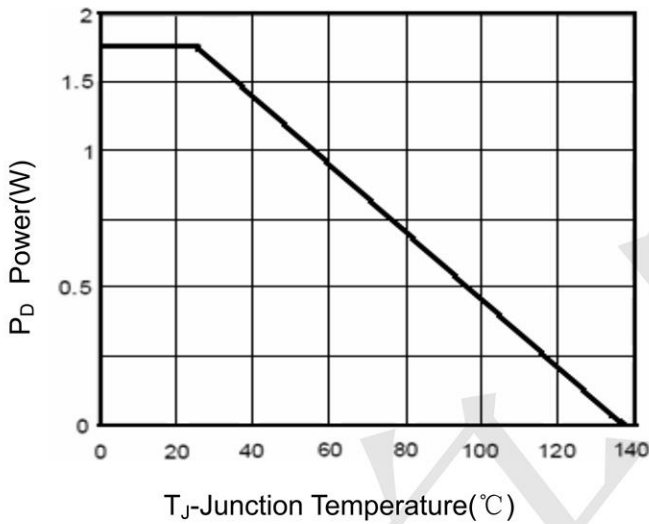

Figure 3 Power Dissipation

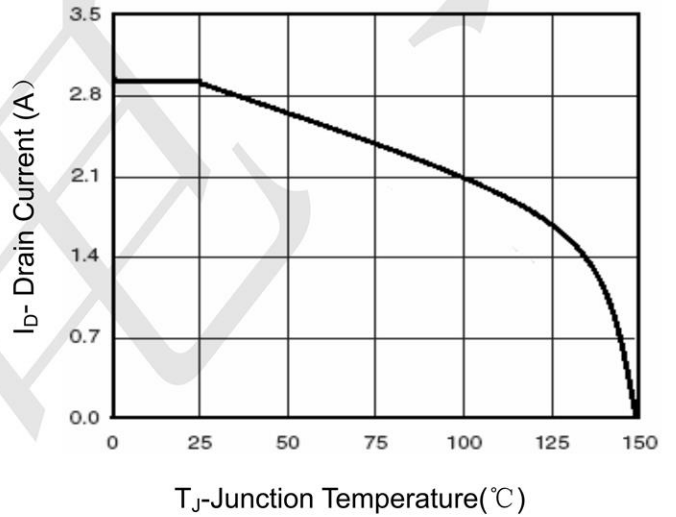

Figure 4 Drain Current

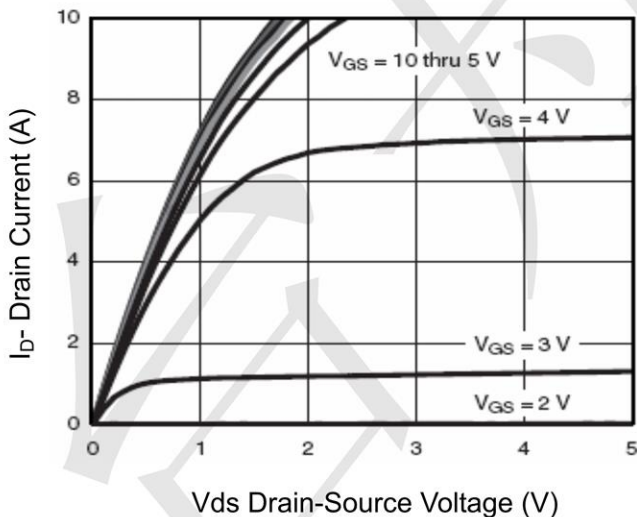

Figure 5 Output Characteristics

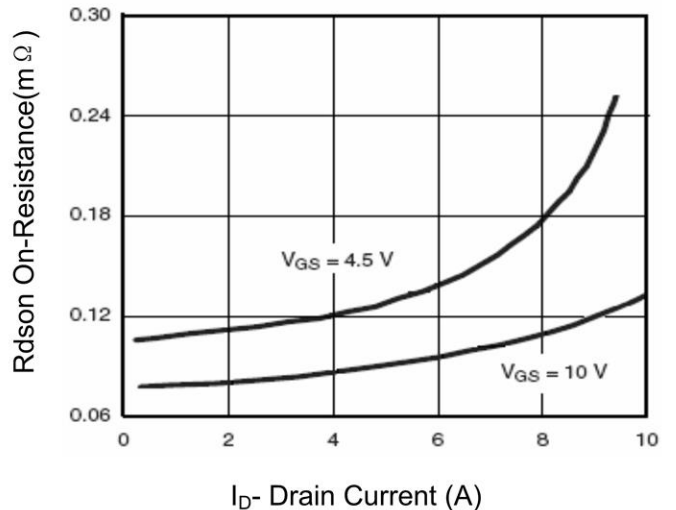

Figure 6 Drain-Source On-Resistance

Typical Electrical and Thermal Characteristics (Curves)

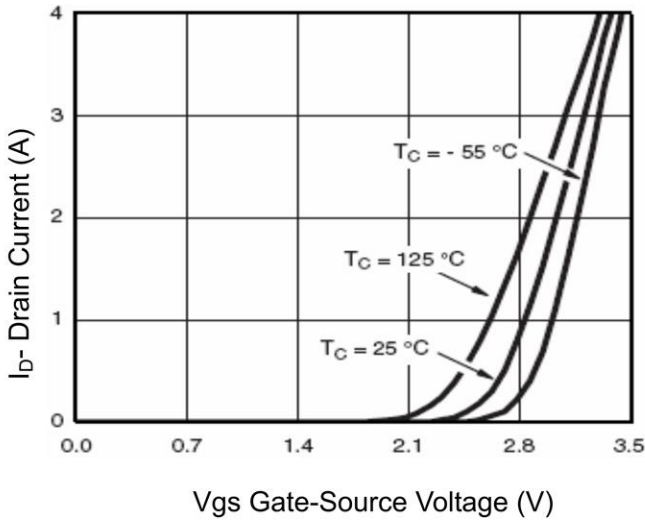

Figure 7 Transfer Characteristics

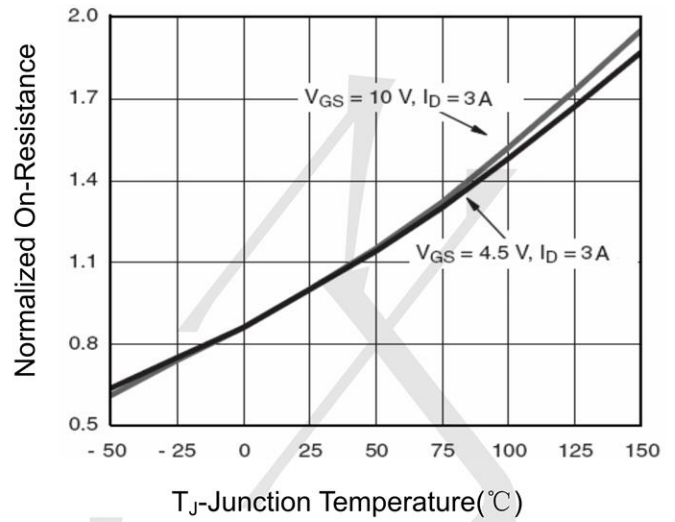

Figure 8 Drain-Source On-Resistance

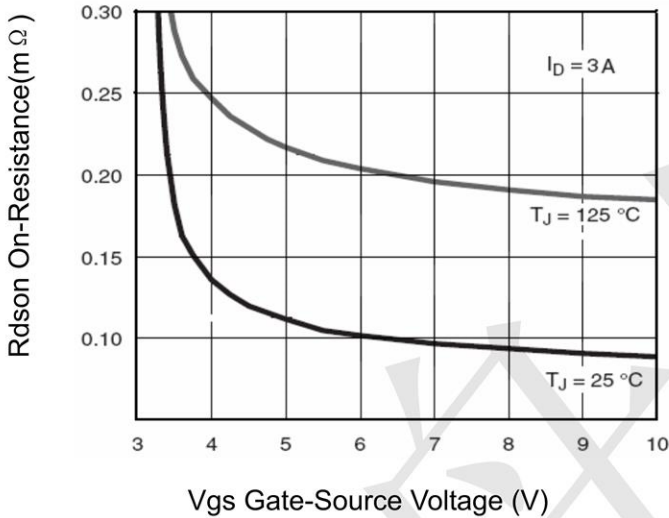

Figure 9 Rdson vs Vgs

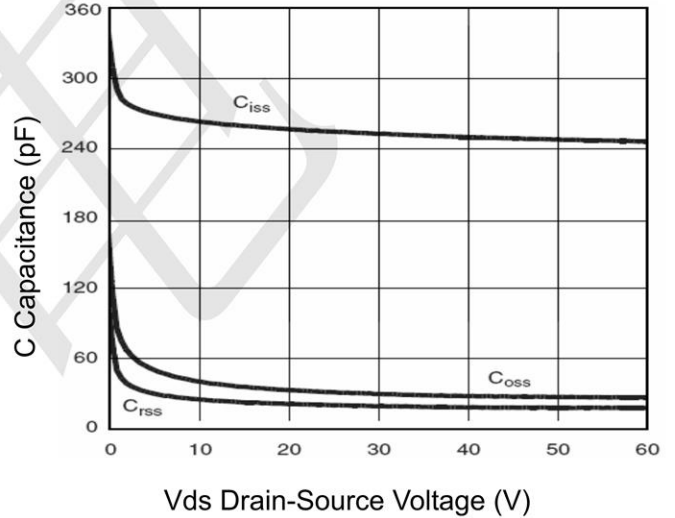

Figure 10 Capacitance vs Vds

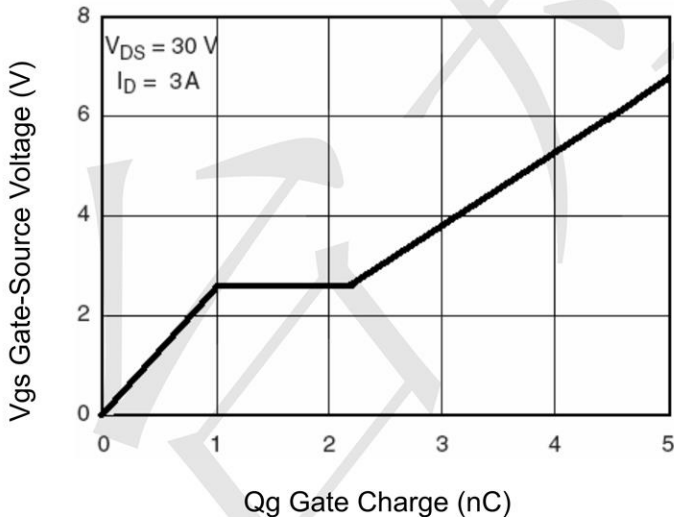

Figure 11 Gate Charge

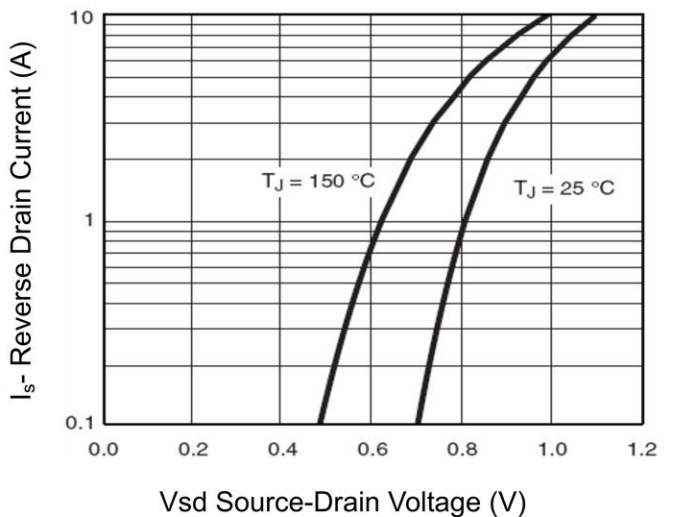

Figure 12 Source- Drain Diode Forward

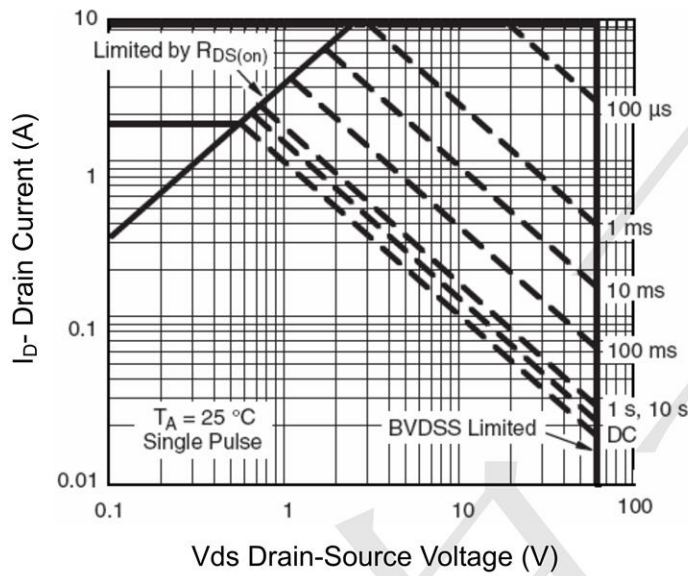

Figure 13 Safe Operation Area

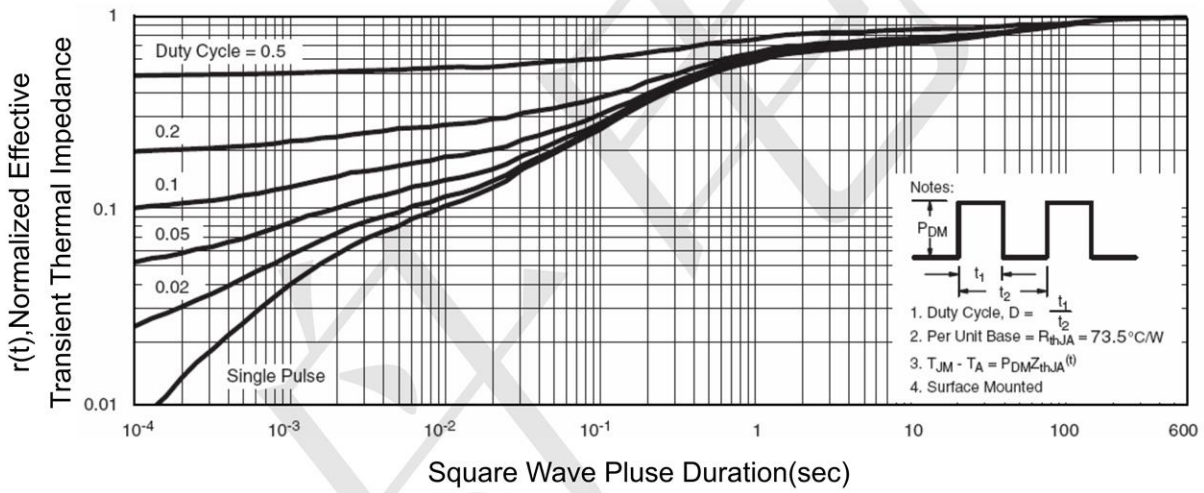
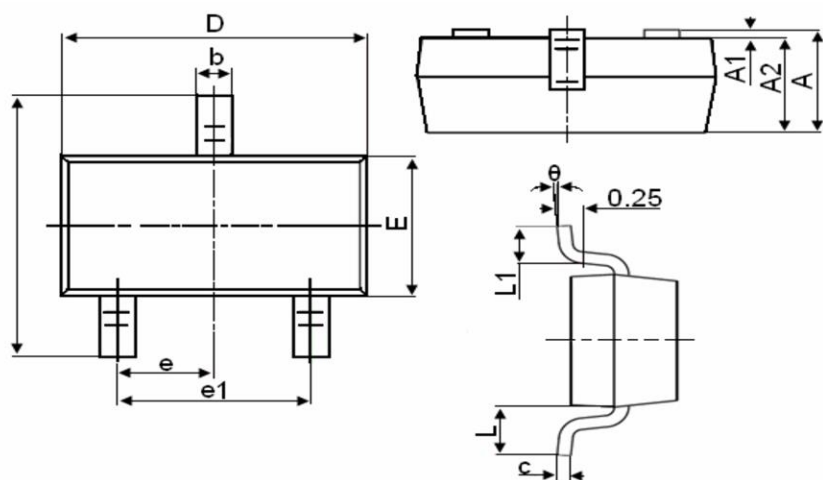

Figure 14 Normalized Maximum Transient Thermal Impedance

Package Outline Dimensions (SOT-23)

www.sot23.com.tw



Symbol	Dimensions in Millimeters	
	MIN.	MAX.
A	0.900	1.150
A1	0.000	0.100
A2	0.900	1.050
b	0.300	0.500
c	0.080	0.150
D	2.800	3.000
E	1.200	1.400
E1	2.250	2.550
e	0.950TYP	
e1	1.800	2.000
L	0.550REF	
L1	0.300	0.500
θ	0°	8°

X-ON Electronics

Largest Supplier of Electrical and Electronic Components

Click to view similar products for [RF MOSFET Transistors](#) category:

Click to view products by [TECH PUBLIC](#) manufacturer:

Other Similar products are found below :

[FH2164](#) [BLF245](#) [ARF465BG](#) [VRF151MP](#) [MRF6S20010GNR1](#) [DU28200M](#) [VRF2933MP](#) [VRF141](#) [MMRF1015NR1](#) [MW6S010GNR1](#)
[DU2820S](#) [MRF24301HR5](#) [ARF463BP1G](#) [ARF465AG](#) [MMRF1014NT1](#) [MRF422](#) [VRF161MP](#) [ARF468BG](#) [MAPHST0045](#)
[A2T27S020NR1](#) [UF2840P](#) [DU2860U](#) [VRF152GMP](#) [MRFE6VP5300NR1](#) [BF2040E6814HTSA1](#) [MRFE6VP5150NR1](#) [MMRF5014HR5](#)
[LET9060S](#) [MRF175GV](#) [AFT27S010NT1](#) [AFT27S006NT1](#) [BF999E6327HTSA1](#) [MRF1K50NR5](#) [UF28150J](#) [MRFE6VP5600HR6](#)
[MRFX1K80HR5](#) [BF998E6327HTSA1](#) [AFM907NT1](#) [AFT05MS006NT1](#) [AFV10700HR5](#) [MRF492](#) [MRF141](#) [MRF171](#) [MRF172](#)
[MRF9045LR1](#) [AFM906NT1](#) [BLF578XR,112](#) [TPM9305PD6](#) [CJU02N65](#) [FDS9926A](#)