

**General Features**

- $V_{DS}=30V$   $I_D=6A$
- $R_{DS(ON)} < 23m\Omega$ ,  $V_{GS}@10V$ ,
- $R_{DS(ON)} < 32m\Omega$ ,  $V_{GS}@4.5V$ ,

**Application**

- Load/Power Switching
- Interfacing Switching
- Battery Management for Ultra Small Portable Electronics
- Logic Level Shift

**Package and Pin Configuration**

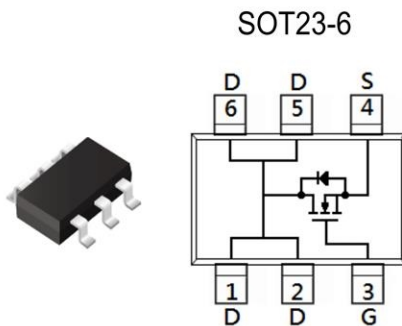

**Marking Information**



**Block Diagram**

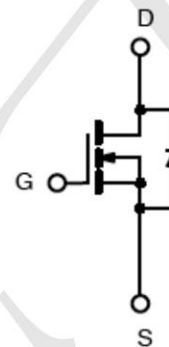

**Absolute Maximum Ratings ( $T_A=25^\circ C$  unless otherwise noted)**

PARAMETER	SYMBOL	LIMIT	UNITS	
Drain-Source Voltage	$V_{DS}$	30	V	
Gate-Source Voltage	$V_{GS}$	+20		
Continuous Drain Current (Note 4)	$I_D$	6	A	
Pulsed Drain Current (Note 1)	$I_{DM}$	25		
Power Dissipation	$P_D$	$T_a=25^\circ C$	2	W
		Derate above $25^\circ C$	16	mW/ $^\circ C$
Operating Junction and Storage Temperature Range	$T_J, T_{STG}$	-55~150	$^\circ C$	
Typical Thermal Resistance	$R_{\theta JA}$	62.5	$^\circ C/W$	
- Junction to Ambient (Note 3)				

Parameter	Conditions	Symbol	Min	Typ	Max	Unit
<b>Static</b>						
Drain-Source Breakdown Voltage	$V_{GS} = 0V, I_D = 250\mu A$	$BV_{DSS}$	30	--	--	V
Drain-Source On-State Resistance	$V_{GS} = 10V, I_D = 6A$	$R_{DS(on)}$	--	18	23	m $\Omega$
	$V_{GS} = 4.5V, I_D = 4A$		--	22	32	
Gate Threshold Voltage	$V_{DS} = V_{GS}, I_D = 250\mu A$	$V_{GS(TH)}$	1.0	1.5	2.5	V
Zero Gate Voltage Drain Current	$V_{DS} = 30V, V_{GS} = 0V$	$I_{DSS}$	--	--	1	$\mu A$
	$V_{DS} = 24V, T_J = 125^\circ C$		--	--	10	
Gate Body Leakage	$V_{GS} = \pm 20V, V_{DS} = 0V$	$I_{GSS}$	--	--	$\pm 100$	$\mu A$
Forward Transconductance <sup>(Note 3)</sup>	$V_{DS} = 10V, I_D = 4A$	$g_{fs}$	--	6.5	--	S
<b>Dynamic</b>						
Total Gate Charge <sup>(Note 3,4)</sup>	$V_{DS} = 15V, I_D = 6A,$ $V_{GS} = 4.5V$	$Q_g$	--	4.1	--	nC
Gate-Source Charge <sup>(Note 3,4)</sup>		$Q_{gs}$	--	1	--	
Gate-Drain Charge <sup>(Note 3,4)</sup>		$Q_{gd}$	--	2.1	--	
Input Capacitance	$V_{DS} = 25V, V_{GS} = 0V,$ $f = 1.0MHz$	$C_{iss}$	--	345	--	pF
Output Capacitance		$C_{oss}$	--	55	--	
Reverse Transfer Capacitance		$C_{rss}$	--	32	--	
<b>Switching</b>						
Turn-On Delay Time <sup>(Note 3,4)</sup>	$V_{DD} = 15V, I_D = 1A,$ $V_{GS} = 10V, R_G = 6\Omega$	$t_{d(on)}$	--	2.8	--	ns
Turn-On Rise Time <sup>(Note 3,4)</sup>		$t_r$	--	7.2	--	
Turn-Off Delay Time <sup>(Note 3,4)</sup>		$t_{d(off)}$	--	15.8	--	
Turn-Off Fall Time <sup>(Note 3,4)</sup>		$t_f$	--	4.6	--	
<b>Source-Drain Diode Ratings and Characteristic</b>						
Maximum Continuous Drain-Source Diode Forward Current	Integral reverse diode in the MOSFET	$I_S$	--	--	6	A
Maximum Pulse Drain-Source Diode Forward Current		$I_{SM}$	--	--	25	A
Diode-Source Forward Voltage	$V_{GS} = 0V, I_S = 1A$	$V_{SD}$	--	--	1	V

**Note:**

1. Pulse width limited by safe operating area
2.  $L = 1mH, I_{AS} = 8A, V_{DD} = 25V, R_G = 25\Omega,$  Starting  $T_J = 25^\circ C$
3. Pulse test: pulse width  $\leq 300\mu s,$  duty cycle  $\leq 2\%$
4. Switching time is essentially independent of operating temperature.

**Typical Electrical and Thermal Characteristics (Curves)**

**Continuous Drain Current vs.  $T_C$**

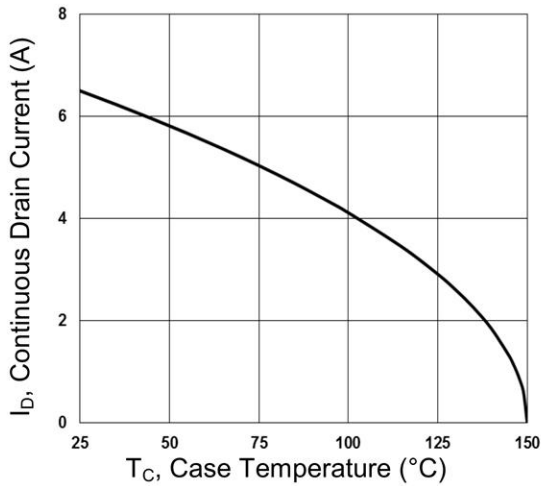

**Gate Charge**

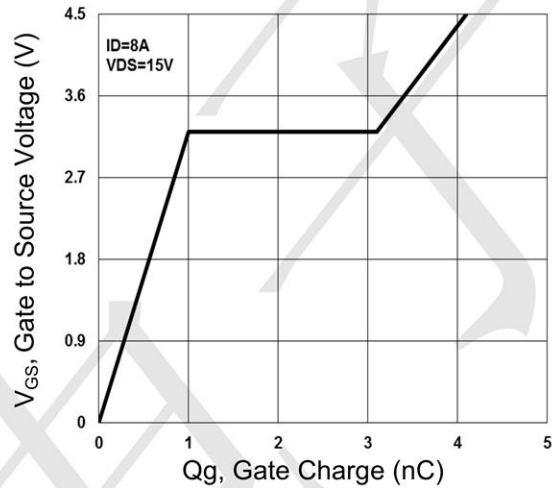

**On-Resistance vs. Junction Temperature**

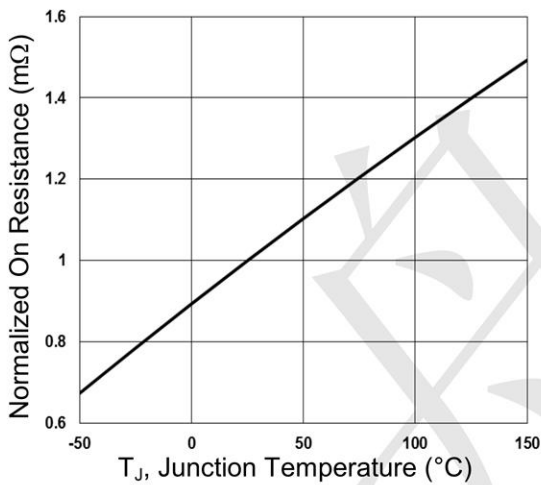

**Threshold Voltage vs. Junction Temperature**

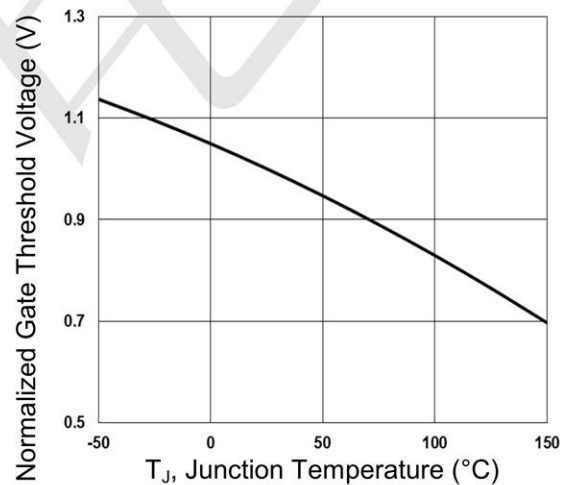

**Maximum Safe Operating Area**

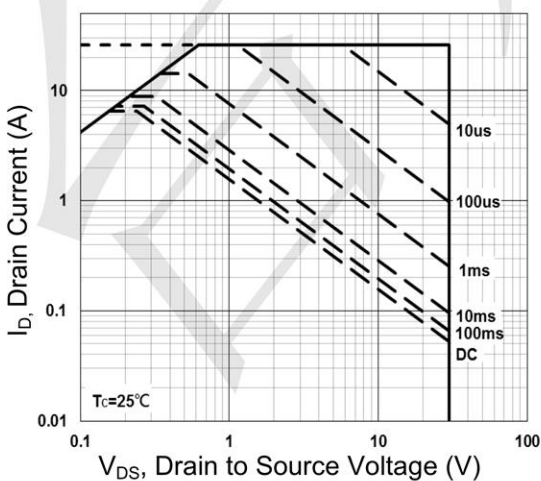

**Normalized Thermal Transient Impedance Curve**

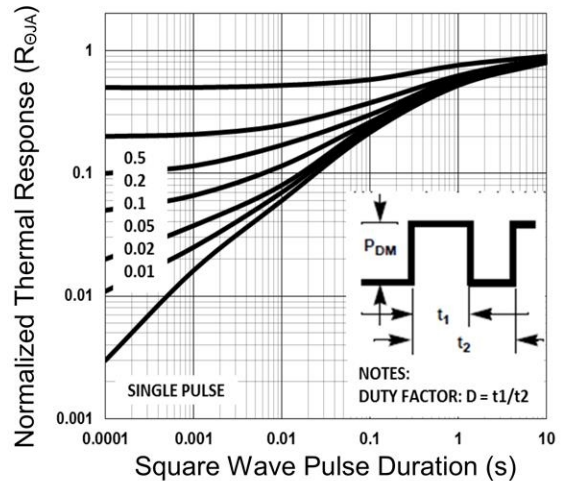

**SOT23-6 Package Information**

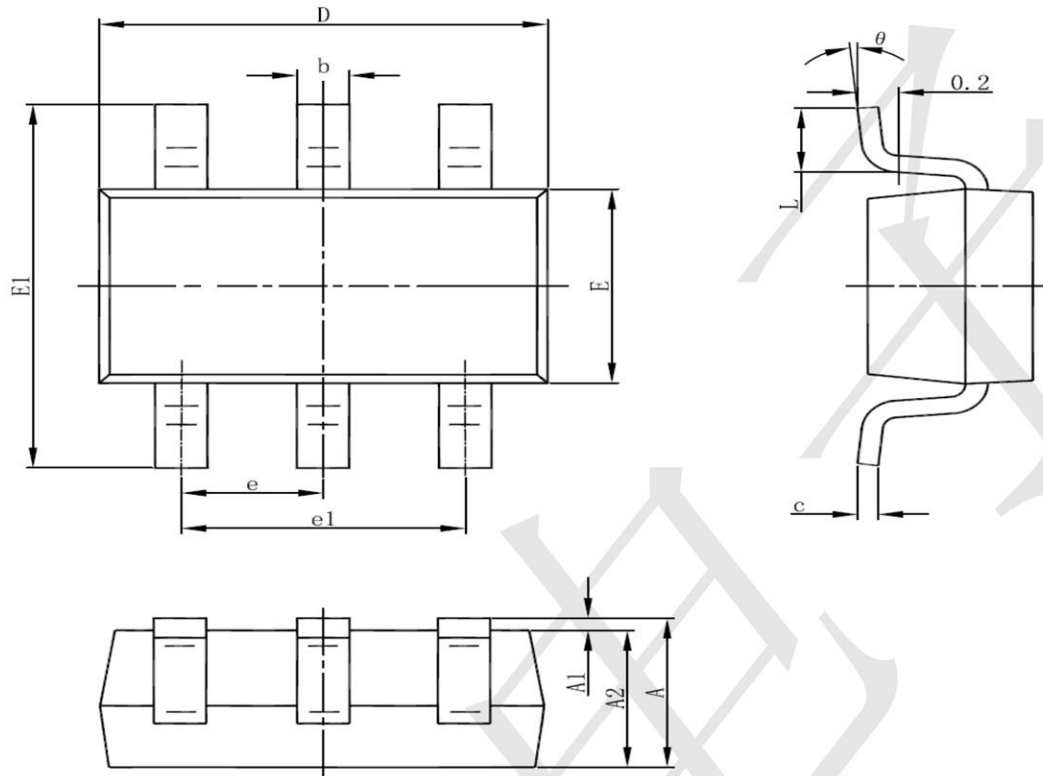

Symbol	Dimensions In Millimeters		Dimensions In Inches	
	Min	Max	Min	Max
A	1.050	1.250	0.041	0.049
A1	0.000	0.100	0.000	0.004
A2	1.050	1.150	0.041	0.045
b	0.300	0.500	0.012	0.020
c	0.100	0.200	0.004	0.008
D	2.820	3.020	0.111	0.119
E	1.500	1.700	0.059	0.067
E1	2.650	2.950	0.104	0.116
e	0.950(BSC)		0.037(BSC)	
e1	1.800	2.000	0.071	0.079
L	0.300	0.600	0.012	0.024
θ	0°	8°	0°	8°

## X-ON Electronics

Largest Supplier of Electrical and Electronic Components

*Click to view similar products for [MOSFET](#) category:*

*Click to view products by [TECH PUBLIC](#) manufacturer:*

Other Similar products are found below :

[614233C](#) [648584F](#) [IRFD120](#) [IRFF430](#) [JANTX2N5237](#) [2N7000](#) [FCA20N60\\_F109](#) [FDZ595PZ](#) [AOD464](#) [2SK2267\(Q\)](#) [2SK2545\(Q,T\)](#)  
[405094E](#) [423220D](#) [MIC4420CM-TR](#) [VN1206L](#) [614234A](#) [715780A](#) [SSM6J414TU,LF\(T](#) [751625C](#) [PSMN4R2-30MLD](#)  
[TK31J60W5,S1VQ\(O](#) [2SK2614\(TE16L1,Q\)](#) [DMN1017UCP3-7](#) [EFC2J004NUZTDG](#) [FCAB21350L1](#) [P85W28HP2F-7071](#) [DMN1053UCP4-7](#)  
[NTE2384](#) [NTE2969](#) [NTE6400A](#) [DMN2080UCB4-7](#) [DMN61D9UWQ-13](#) [US6M2GTR](#) [DMN31D5UDJ-7](#) [SSM6P54TU,LF](#) [DMP22D4UFO-](#)  
[7B](#) [IPS60R3K4CEAKMA1](#) [DMN1006UCA6-7](#) [DMN16M9UCA6-7](#) [STF5N65M6](#) [STU5N65M6](#) [C3M0021120D](#) [DMN13M9UCA6-7](#)  
[BSS340NWH6327XTSA1](#) [MCM3400A-TP](#) [DMTH10H4M6SPS-13](#) [IRF40SC240ARMA1](#) [IPS60R1K0PFD7SAKMA1](#)  
[IPS60R360PFD7SAKMA1](#) [IPS60R600PFD7SAKMA1](#)