

GENERAL FEATURES

N-CH	BV_{DSS}	30V
	$R_{DS(ON)}$	22m Ω
	I_D	7A
P-CH	BV_{DSS}	-30V
	$R_{DS(ON)}$	30m Ω
	I_D	-6.0A

Application

- Battery protection
- Load switch

Package and Pin Configuration

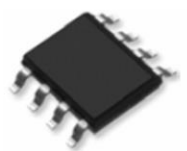

SOP-8 top view

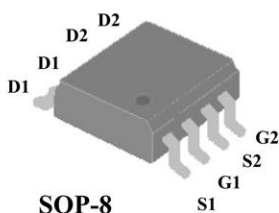

SOP-8

Circuit diagram

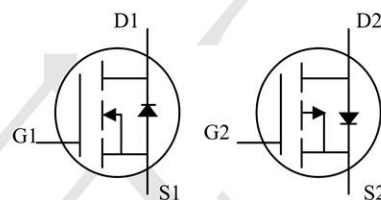

Marking:

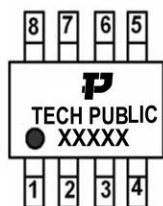

“P” is TECHPUBLIC LOGO

“XXXXX” Marking ID (Please see the last page for details)

Absolute Maximum Ratings ($T_A=25^\circ\text{C}$ unless otherwise noted)

PARAMETER	SYMBOL	N-CH LIMIT	P-CH LIMIT	UNITS	
Drain-Source Voltage	V_{DS}	30	-30	V	
Gate-Source Voltage	V_{GS}	+20			
Continuous Drain Current (Note 4)	I_D	$T_A=25^\circ\text{C}$	7	-6	A
		$T_A=70^\circ\text{C}$	5.6	-5	
Pulsed Drain Current (Note 1)	I_{DM}	$T_C=25^\circ\text{C}$	28	-24	
Power Dissipation	P_D	$T_A=25^\circ\text{C}$	1.7		W
		$T_A=70^\circ\text{C}$	1.1		
Operating Junction and Storage Temperature Range	T_J, T_{STG}	-55~150		$^\circ\text{C}$	
Typical Thermal Resistance Junction to Ambient (Note 4,5)	$R_{\theta JA}$	73.5		$^\circ\text{C/W}$	

N-CH Electrical Characteristics ($T_A=25^\circ\text{C}$ unless otherwise noted)

PARAMETER	SYMBOL	TEST CONDITION	MIN.	TYP.	MAX.	UNITS
Static						
Drain-Source Breakdown Voltage	BV_{DSS}	$V_{GS}=0V, I_D=250\mu A$	30	-	-	V
Gate Threshold Voltage	$V_{GS(th)}$	$V_{DS}=V_{GS}, I_D=250\mu A$	1	1.67	2.5	
Drain-Source On-State Resistance	$R_{DS(on)}$	$V_{GS}=10V, I_D=6A$	-	-	22	m Ω
Drain-Source On-State Resistance	$R_{DS(on)}$	$V_{GS}=4.5V, I_D=3A$	-	-	28	
Zero Gate Voltage Drain Current	I_{DSS}	$V_{DS}=30V, V_{GS}=0V$	-	-	1	μA
Gate-Source Leakage Current	I_{GSS}	$V_{GS}=\pm 20V, V_{DS}=0V$	-	-	± 100	nA
Dynamic (Note 6)						
Total Gate Charge	Q_g	$V_{DS}=15V, I_D=8A,$ $V_{GS}=4.5V$ (Note 2,3)	-	4.8	-	nC
Gate-Source Charge	Q_{gs}		-	1.5	-	
Gate-Drain Charge	Q_{gd}		-	2	-	
Input Capacitance	C_{iss}	$V_{DS}=25V, V_{GS}=0V,$ $f=1\text{MHz}$	-	429	-	pF
Output Capacitance	C_{oss}		-	59	-	
Reverse Transfer Capacitance	C_{rss}		-	47	-	
Turn-On Delay Time	$t_{d(on)}$	$V_{DS}=15V, I_D=1A,$ $V_{GS}=10V, R_G=6\Omega$ (Note 2,3)	-	6.8	-	ns
Turn-On Rise Time	t_r		-	16	-	
Turn-Off Delay Time	$t_{d(off)}$		-	27	-	
Turn-Off Fall Time	t_f		-	7.1	-	
Drain-Source Diode						
Maximum Continuous Drain-Source Diode Forward Current	I_S	---	-	-	7	A
Diode Forward Voltage	V_{SD}	$I_S=1A, V_{GS}=0V$	-	0.74	1	V

PARAMETER	SYMBOL	TEST CONDITION	MIN.	TYP.	MAX.	UNITS
Static						
Drain-Source Breakdown Voltage	BV_{DSS}	$V_{GS}=0V, I_D=-250\mu A$	-30	-	-	V
Gate Threshold Voltage	$V_{GS(th)}$	$V_{DS}=V_{GS}, I_D=-250\mu A$	-1	-1.53	-2.5	
Drain-Source On-State Resistance	$R_{DS(on)}$	$V_{GS}=-10V, I_D=-4A$	-	-	30	mΩ
Drain-Source On-State Resistance	$R_{DS(on)}$	$V_{GS}=-4.5V, I_D=-2A$	-	-	45	
Zero Gate Voltage Drain Current	I_{DSS}	$V_{DS}=-30V, V_{GS}=0V$	-	-	-1	μA
Gate-Source Leakage Current	I_{GSS}	$V_{GS}=+20V, V_{DS}=0V$	-	-	±100	nA
Dynamic <small>(Note 6)</small>						
Total Gate Charge	Q_g	$V_{DS}=-15V, I_D=-4A,$ $V_{GS}=-4.5V$ <small>(Note 1,2)</small>	-	7.8	-	nC
Gate-Source Charge	Q_{gs}		-	2.7	-	
Gate-Drain Charge	Q_{gd}		-	2.8	-	
Input Capacitance	C_{iss}	$V_{DS}=-15V, V_{GS}=0V,$ $f=1MHz$	-	846	-	pF
Output Capacitance	C_{oss}		-	120	-	
Reverse Transfer Capacitance	C_{rss}		-	76	-	
Turn-On Delay Time	$t_{d(on)}$	$V_{DS}=-15V, I_D=-1A,$ $V_{GS}=-10V, R_G=6\Omega$ <small>(Note 1,2)</small>	-	3.6	-	ns
Turn-On Rise Time	t_r		-	23	-	
Turn-Off Delay Time	$t_{d(off)}$		-	90	-	
Turn-Off Fall Time	t_f		-	50	-	
Drain-Source Diode						
Maximum Continuous Drain-Source Diode Forward Current	I_S	---	-	-	-6	A
Diode Forward Voltage	V_{SD}	$I_S=-1A, V_{GS}=0V$	-	-0.75	-1	V

Typical Electrical and Thermal Characteristics (Curves)

N-Channel Typical Operating Characteristics

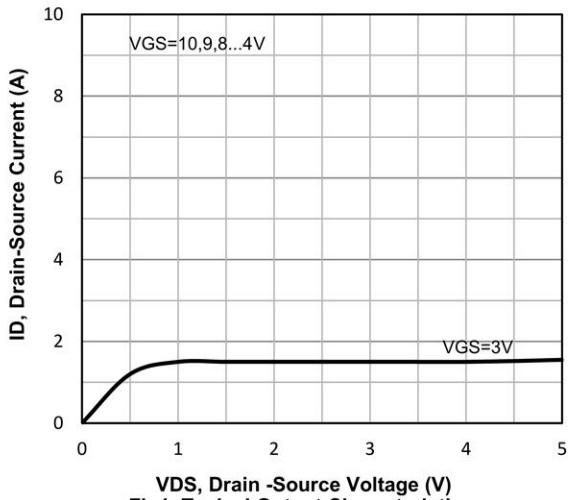

Fig1. Typical Output Characteristics

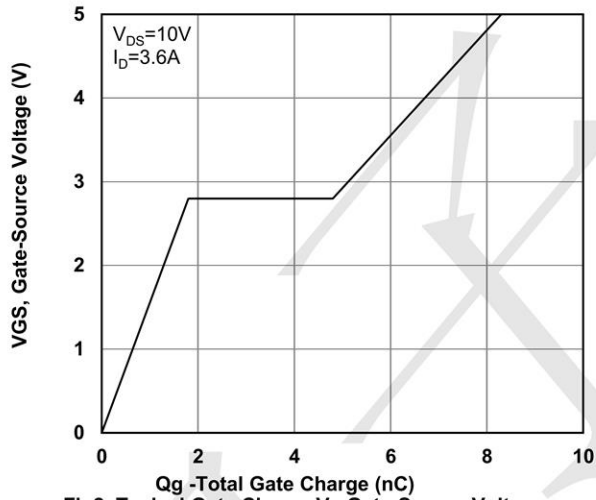

Fig2. Typical Gate Charge Vs. Gate-Source Voltage

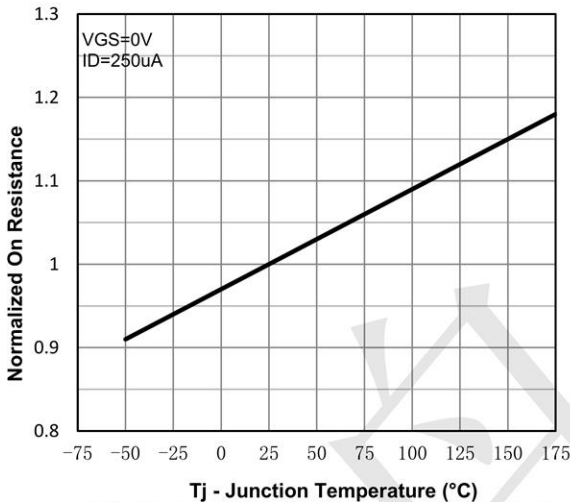

Fig3. Normalized On-Resistance Vs. Temperature

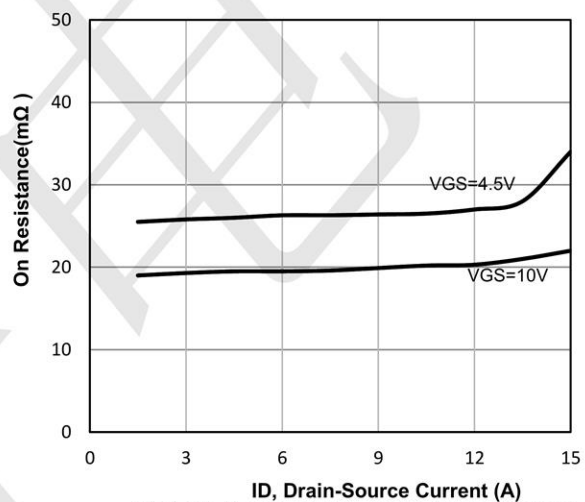

Fig4. On-Resistance Vs. Drain-Source Current

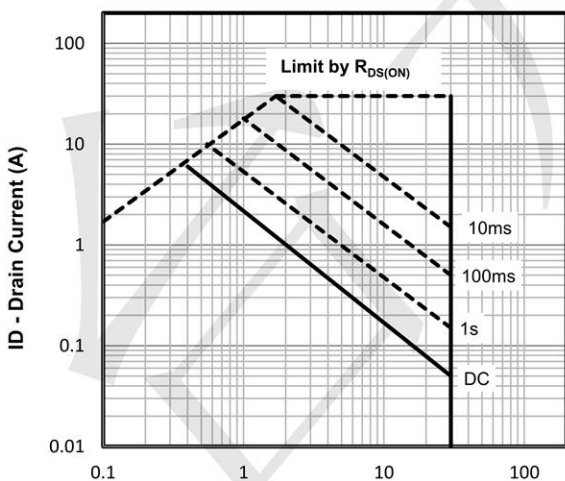

Fig7. Maximum Safe Operating Area

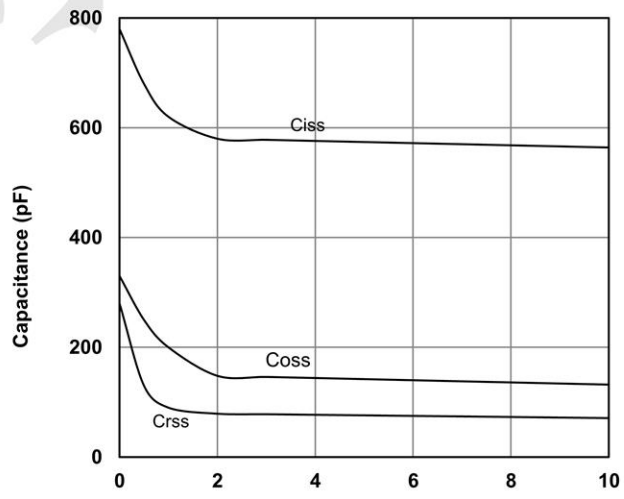
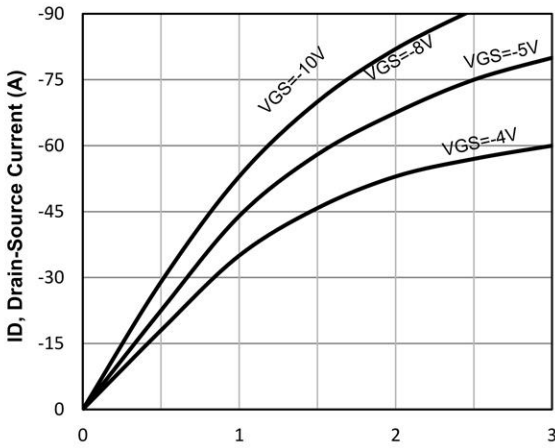
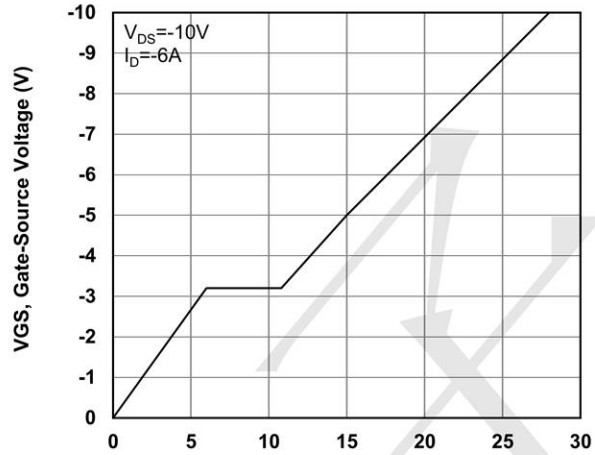

Fig6 Typical Capacitance Vs. Drain-Source Voltage

P-Channel Typical Operating Characteristics



VDS, Drain -Source Voltage (V)
Fig1. Typical Output Characteristics



Qg -Total Gate Charge (nC)
Fig2. Typical Gate Charge Vs. Gate-Source Voltage

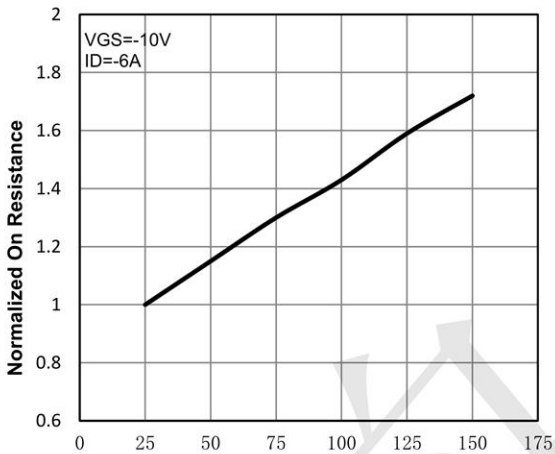

Tj - Junction Temperature (°C)
Fig3. Normalized On-Resistance Vs. Temperature

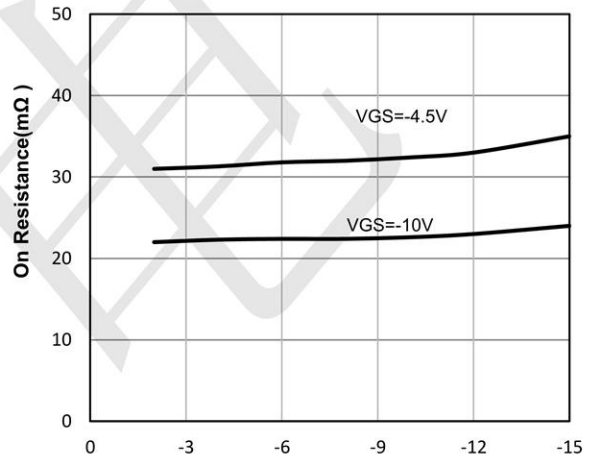

ID, Drain-Source Current (A)
Fig4. On-Resistance Vs. Drain-Source Current

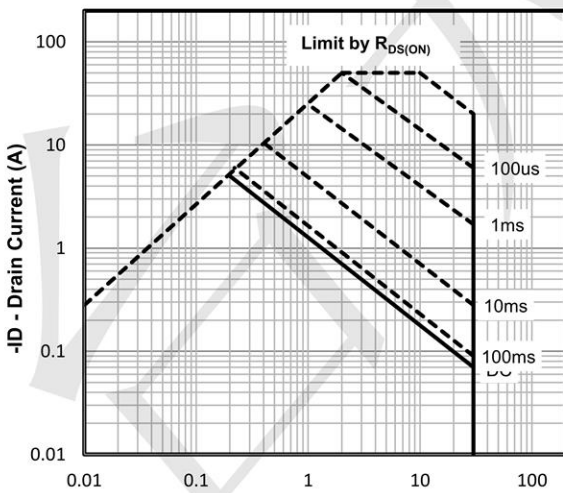

-VDS, Drain -Source Voltage (V)
Fig7. Maximum Safe Operating Area

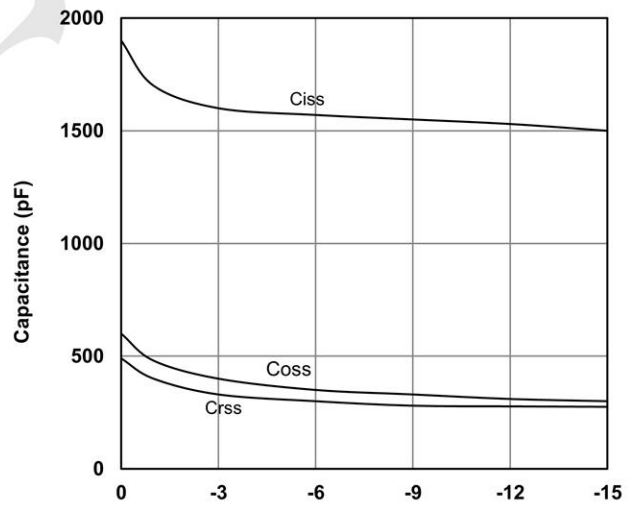

VDS, Drain-Source Voltage (V)
Fig6. Typical Capacitance Vs. Drain-Source Voltage

SOP-8 Package Information

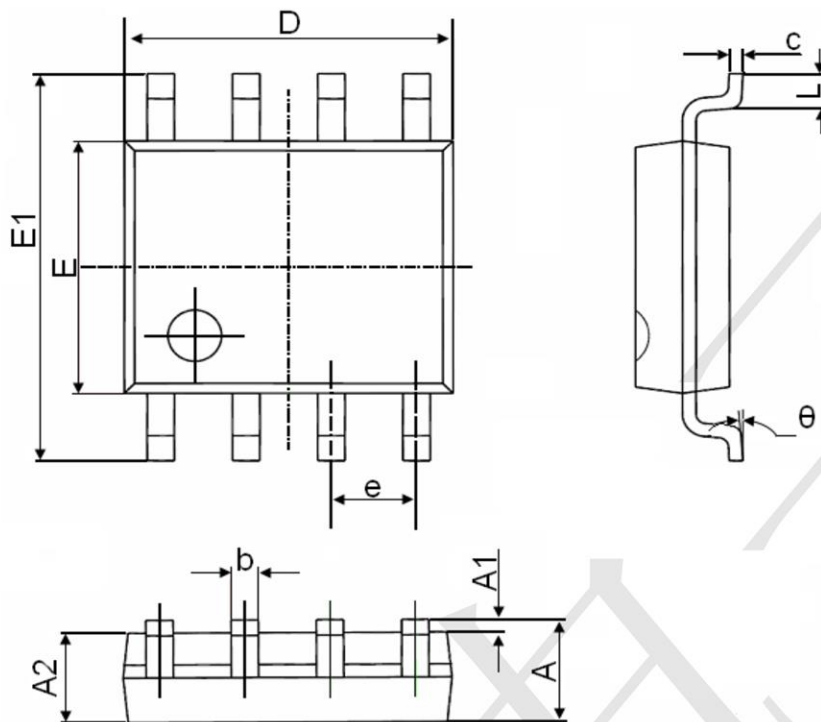

Symbol	Dimensions In Millimeters		Dimensions In Inches	
	Min.	Max.	Min.	Max.
A	1.350	1.750	0.053	0.069
A1	0.100	0.250	0.004	0.010
A2	1.350	1.550	0.053	0.061
b	0.330	0.510	0.013	0.020
c	0.170	0.250	0.006	0.010
D	4.700	5.100	0.185	0.200
E	3.800	4.000	0.150	0.157
E1	5.800	6.200	0.228	0.244
e	1.270(BSC)		0.050(BSC)	
L	0.400	1.270	0.016	0.050
theta	0°	8°	0°	8°

Marking:

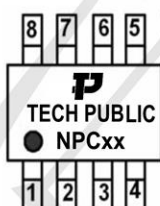

“P” is TECHPUBLIC LOGO
 “NPC” is Part number, fixed
 “xx” is internal code

X-ON Electronics

Largest Supplier of Electrical and Electronic Components

Click to view similar products for [MOSFET](#) category:

Click to view products by [TECH PUBLIC](#) manufacturer:

Other Similar products are found below :

[614233C](#) [648584F](#) [IRFD120](#) [IRFF430](#) [JANTX2N5237](#) [2N7000](#) [FCA20N60_F109](#) [FDZ595PZ](#) [AOD464](#) [2SK2267\(Q\)](#) [2SK2545\(Q,T\)](#)
[405094E](#) [423220D](#) [MIC4420CM-TR](#) [VN1206L](#) [614234A](#) [715780A](#) [SSM6J414TU,LF\(T](#) [751625C](#) [PSMN4R2-30MLD](#)
[TK31J60W5,S1VQ\(O](#) [2SK2614\(TE16L1,Q\)](#) [DMN1017UCP3-7](#) [EFC2J004NUZTDG](#) [FCAB21350L1](#) [P85W28HP2F-7071](#) [DMN1053UCP4-7](#)
[NTE2384](#) [NTE2969](#) [NTE6400A](#) [DMN2080UCB4-7](#) [DMN61D9UWQ-13](#) [US6M2GTR](#) [DMN31D5UDJ-7](#) [SSM6P54TU,LF](#) [DMP22D4UFO-](#)
[7B](#) [IPS60R3K4CEAKMA1](#) [DMN1006UCA6-7](#) [DMN16M9UCA6-7](#) [STF5N65M6](#) [STU5N65M6](#) [C3M0021120D](#) [DMN13M9UCA6-7](#)
[BSS340NWH6327XTSA1](#) [MCM3400A-TP](#) [DMTH10H4M6SPS-13](#) [IRF40SC240ARMA1](#) [IPS60R1K0PFD7SAKMA1](#)
[IPS60R360PFD7SAKMA1](#) [IPS60R600PFD7SAKMA1](#)