

General Features

● **N-Channel**

$V_{DS} = 40V, I_D = 8A$

$R_{DS(ON)} < 19m\Omega @ V_{GS} = 10V$

$R_{DS(ON)} < 29m\Omega @ V_{GS} = 4.5V$

● **P-Channel**

$V_{DS} = -40V, I_D = -7A$

$R_{DS(ON)} < 35m\Omega @ V_{GS} = -10V$

$R_{DS(ON)} < 45m\Omega @ V_{GS} = -4.5V$

Application

- High power and current handing capability
- Lead free product is acquired
- Surface mount package

Package and Pin Configuration

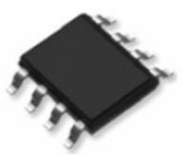

SOP-8 top view

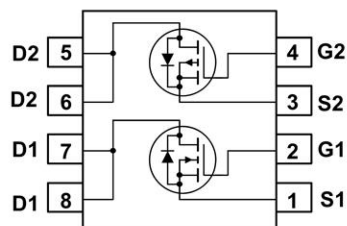

Circuit diagram

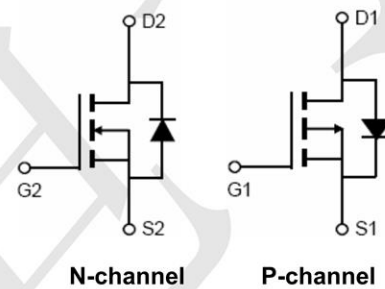

Marking

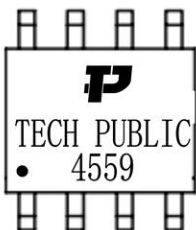

Absolute Maximum Ratings ($T_A = 25^\circ C$ unless otherwise noted)

| Parameter | Symbol | N-Channel | P-Channel | Unit | |
|--|----------------|--------------------|------------|------------|---|
| Drain-Source Voltage | V_{DS} | 40 | -40 | V | |
| Gate-Source Voltage | V_{GS} | ± 20 | ± 20 | V | |
| Continuous Drain Current | I_D | $T_A = 25^\circ C$ | 8 | -7 | A |
| | | $T_A = 70^\circ C$ | 6 | -5.5 | |
| Pulsed Drain Current ^(Note 1) | I_{DM} | 40 | -30 | A | |
| Maximum Power Dissipation | P_D | 2.0 | 2.0 | W | |
| Operating Junction and Storage Temperature Range | T_J, T_{STG} | -55 To 150 | -55 To 150 | $^\circ C$ | |

Thermal Characteristic

| | | | | |
|---|-----------------|------|------|--------------|
| Thermal Resistance, Junction-to-Ambient ^(Note 2) | $R_{\theta JA}$ | N-Ch | 62.5 | $^\circ C/W$ |
| Thermal Resistance, Junction-to-Ambient ^(Note 2) | $R_{\theta JA}$ | P-Ch | 62.5 | $^\circ C/W$ |

N-CH Electrical Characteristics (T_A=25°C unless otherwise noted)

| Parameter | Symbol | Condition | Min | Typ | Max | Unit |
|---|---------------------|--|-----|-----|------|------|
| Off Characteristics | | | | | | |
| Drain-Source Breakdown Voltage | BV _{DSS} | V _{GS} =0V, I _D =250μA | 40 | - | - | V |
| Zero Gate Voltage Drain Current | I _{DSS} | V _{DS} =40V, V _{GS} =0V | - | - | 1 | μA |
| Gate-Body Leakage Current | I _{GSS} | V _{GS} =±20V, V _{DS} =0V | - | - | ±100 | nA |
| On Characteristics (Note 3) | | | | | | |
| Gate Threshold Voltage | V _{GS(th)} | V _{DS} =V _{GS} , I _D =250μA | 1 | 1.5 | 2.0 | V |
| Drain-Source On-State Resistance | R _{DS(ON)} | V _{GS} =10V, I _D =8A | - | 14 | 19 | mΩ |
| | | V _{GS} =4.5V, I _D =4A | - | 19 | 29 | mΩ |
| Forward Transconductance | g _{FS} | V _{DS} =5V, I _D =8A | 33 | - | - | S |
| Dynamic Characteristics (Note 4) | | | | | | |
| Input Capacitance | C _{iss} | V _{DS} =20V, V _{GS} =0V, F=1.0MHz | - | 415 | - | PF |
| Output Capacitance | C _{oss} | | - | 112 | - | PF |
| Reverse Transfer Capacitance | C _{rss} | | - | 11 | - | PF |
| Switching Characteristics (Note 4) | | | | | | |
| Turn-on Delay Time | t _{d(on)} | V _{DD} =20V, R _L =2.5Ω V _{GS} =10V, R _{GEN} =3Ω | - | 4 | - | nS |
| Turn-on Rise Time | t _r | | - | 3 | - | nS |
| Turn-Off Delay Time | t _{d(off)} | | - | 15 | - | nS |
| Turn-Off Fall Time | t _f | | - | 2 | - | nS |
| Total Gate Charge | Q _g | V _{DS} =20V, I _D =8A, V _{GS} =10V | - | 12 | - | nC |
| Gate-Source Charge | Q _{gs} | | - | 3.2 | - | nC |
| Gate-Drain Charge | Q _{gd} | | - | 3.1 | - | nC |
| Drain-Source Diode Characteristics | | | | | | |
| Diode Forward Voltage (Note 3) | V _{SD} | V _{GS} =0V, I _S =8A | - | 0.8 | 1.2 | V |

P-CH Electrical Characteristics ($T_A=25^\circ\text{C}$ unless otherwise noted)

| Parameter | Symbol | Condition | Min | Typ | Max | Unit |
|---|--------------|--|------|------|-----------|------------|
| Off Characteristics | | | | | | |
| Drain-Source Breakdown Voltage | BV_{DSS} | $V_{GS}=0V, I_D=-250\mu A$ | -40 | - | - | V |
| Zero Gate Voltage Drain Current | I_{DSS} | $V_{DS}=-40V, V_{GS}=0V$ | - | - | -1 | μA |
| Gate-Body Leakage Current | I_{GSS} | $V_{GS}=\pm 20V, V_{DS}=0V$ | - | - | ± 100 | nA |
| On Characteristics (Note 3) | | | | | | |
| Gate Threshold Voltage | $V_{GS(th)}$ | $V_{DS}=V_{GS}, I_D=-250\mu A$ | -1.0 | -1.5 | -2.0 | V |
| Drain-Source On-State Resistance | $R_{DS(on)}$ | $V_{GS}=-10V, I_D=-8A$ | - | 29 | 35 | m Ω |
| | | $V_{GS}=-4.5V, I_D=-4A$ | - | 34 | 45 | m Ω |
| Forward Transconductance | g_{FS} | $V_{DS}=-5V, I_D=-8A$ | 20 | - | - | S |
| Dynamic Characteristics (Note 4) | | | | | | |
| Input Capacitance | C_{iss} | $V_{DS}=-20V, V_{GS}=0V,$ $F=1.0\text{MHz}$ | - | 520 | - | PF |
| Output Capacitance | C_{oss} | | - | 100 | - | PF |
| Reverse Transfer Capacitance | C_{rss} | | - | 65 | - | PF |
| Switching Characteristics (Note 4) | | | | | | |
| Turn-on Delay Time | $t_{d(on)}$ | $V_{DD}=-20V, R_L=2.3\Omega$ $V_{GS}=-10V, R_{GEN}=6\Omega$ | - | 7.5 | - | nS |
| Turn-on Rise Time | t_r | | - | 5.5 | - | nS |
| Turn-Off Delay Time | $t_{d(off)}$ | | - | 19 | - | nS |
| Turn-Off Fall Time | t_f | | - | 7 | - | nS |
| Total Gate Charge | Q_g | $V_{DS}=-20V, I_D=-8A$ $V_{GS}=-10V$ | - | 13 | - | nC |
| Gate-Source Charge | Q_{gs} | | - | 3.8 | - | nC |
| Gate-Drain Charge | Q_{gd} | | - | 3.1 | - | nC |
| Drain-Source Diode Characteristics | | | | | | |
| Diode Forward Voltage (Note 3) | V_{SD} | $V_{GS}=0V, I_S=-10A$ | - | - | -1.2 | V |

N- Channel Typical Electrical and Thermal Characteristics (Curves)

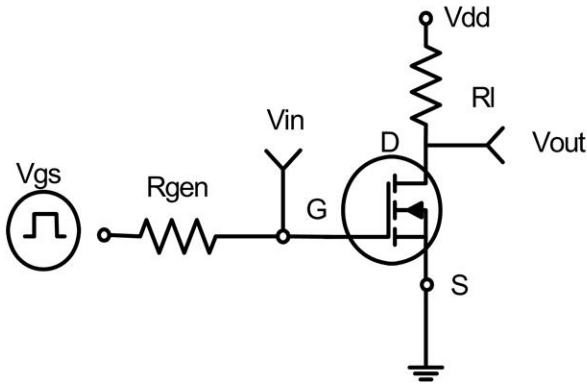

Figure 1: Switching Test Circuit

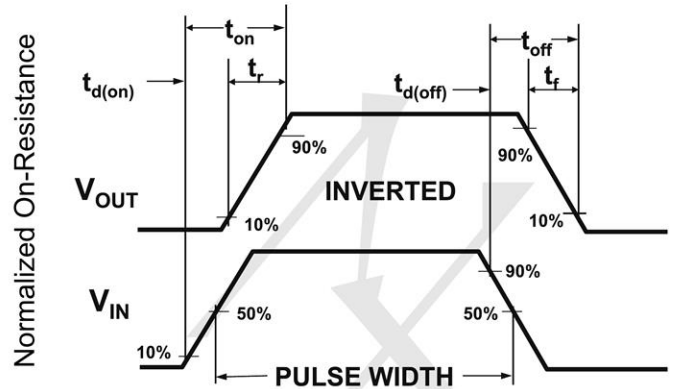

Figure 2: Switching Waveforms

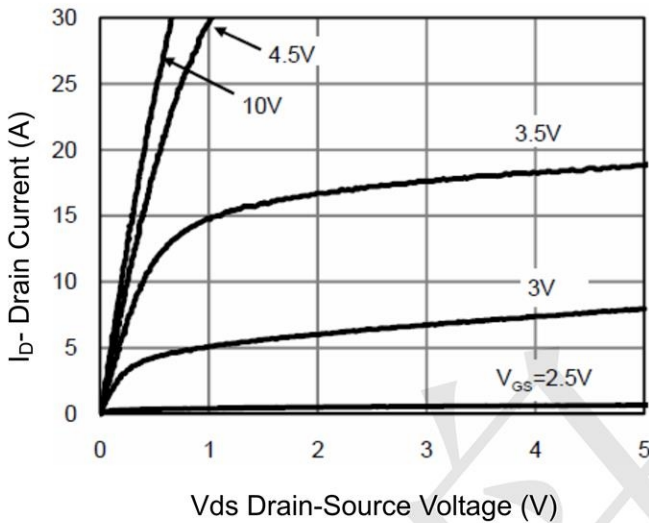

Figure 3 Output Characteristics

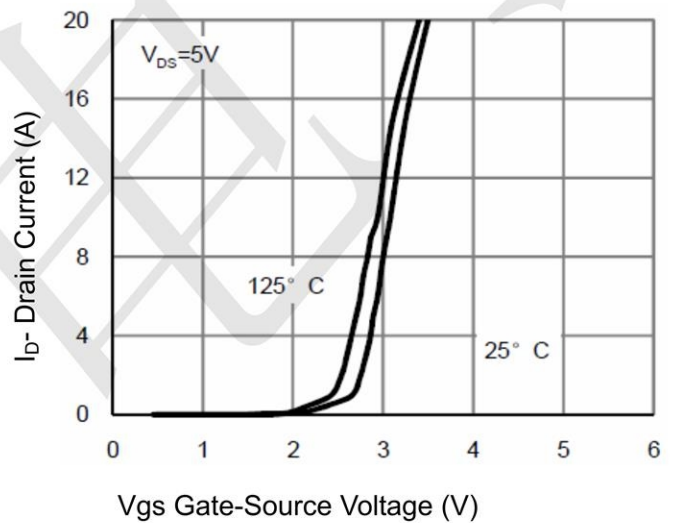

Figure 4 Transfer Characteristics

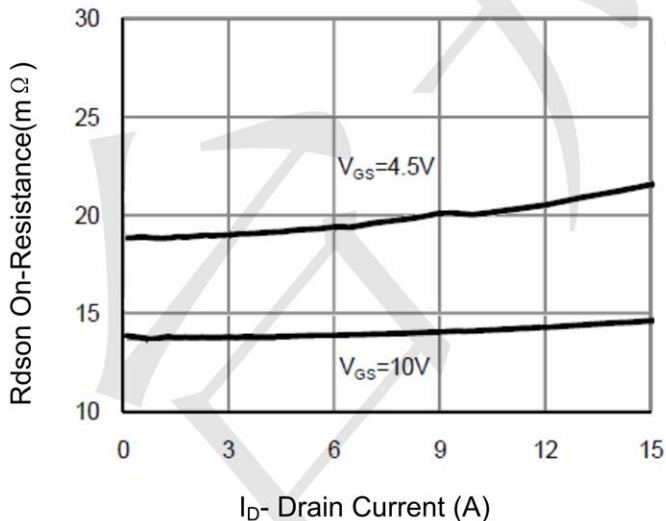

Figure 5 Drain-Source On-Resistance

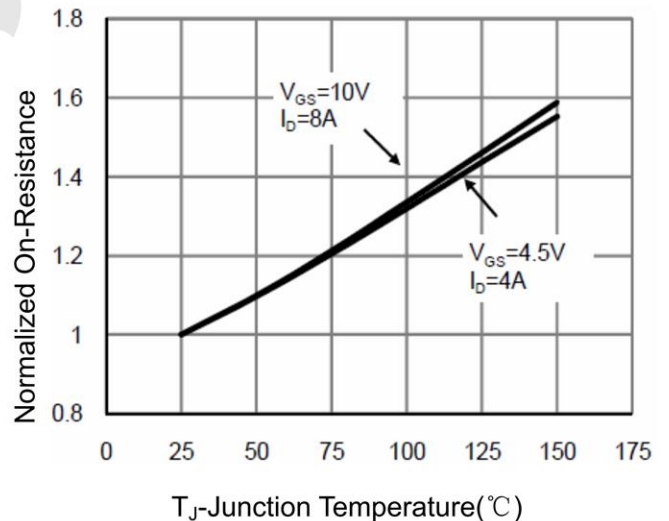

Figure 6 Drain-Source On-Resistance

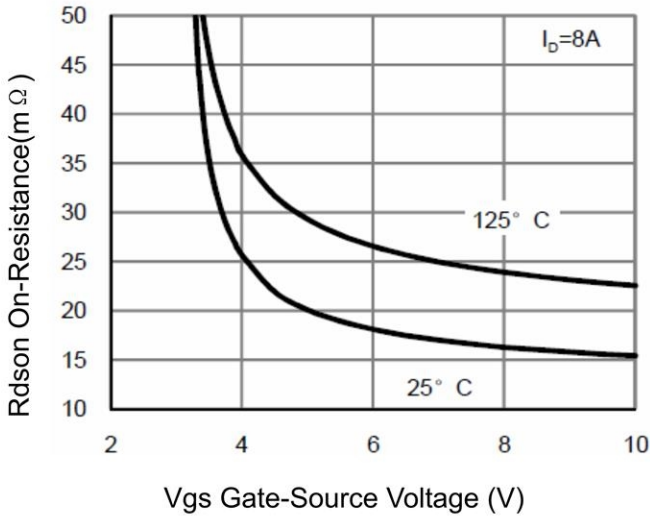

Figure 7 Rdson vs Vgs

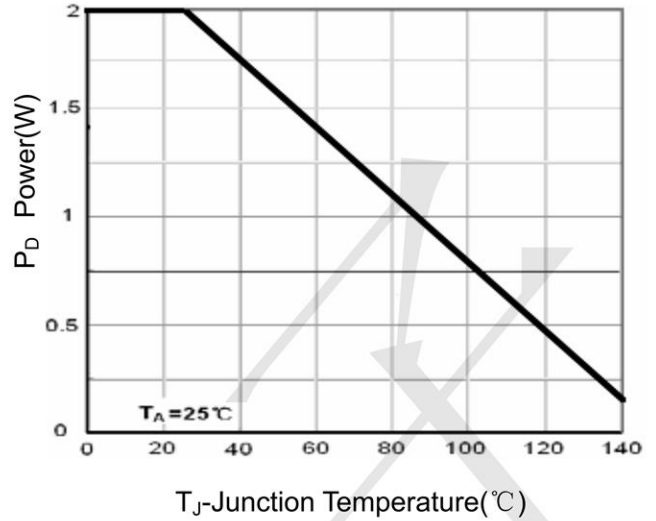

Figure 8 Power Dissipation

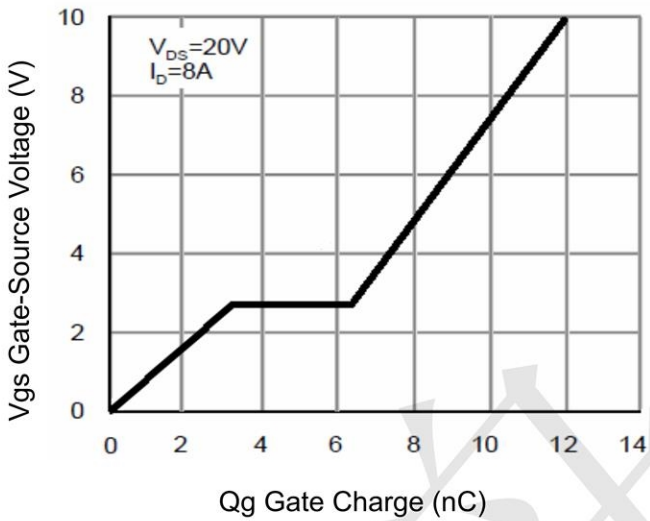

Figure 9 Gate Charge

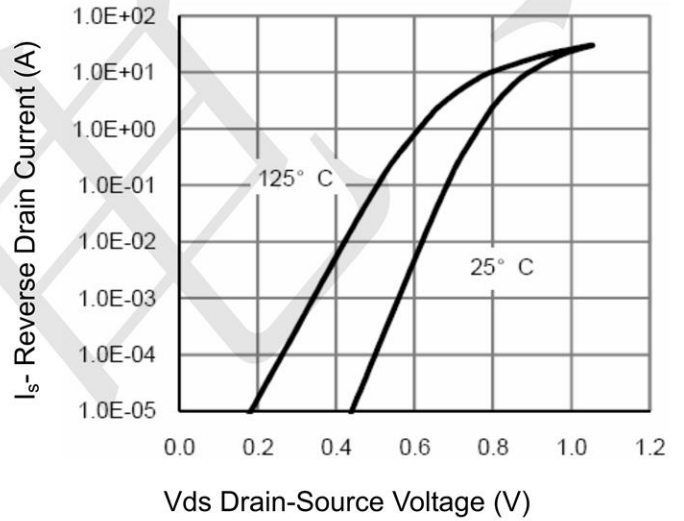

Figure 10 Source- Drain Diode Forward

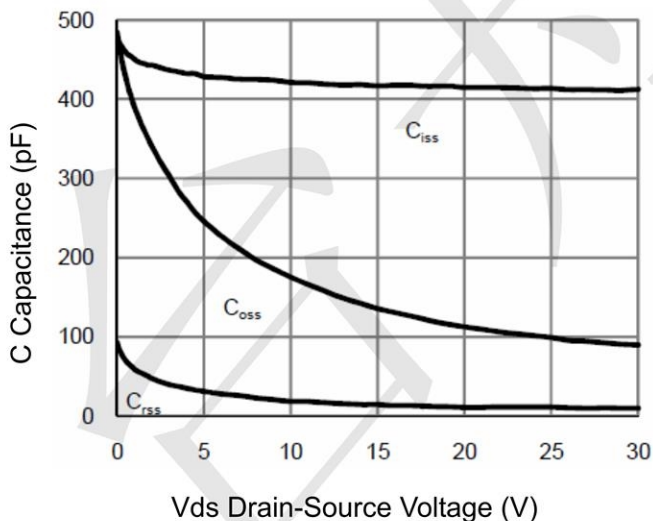

Figure 11 Capacitance vs Vds

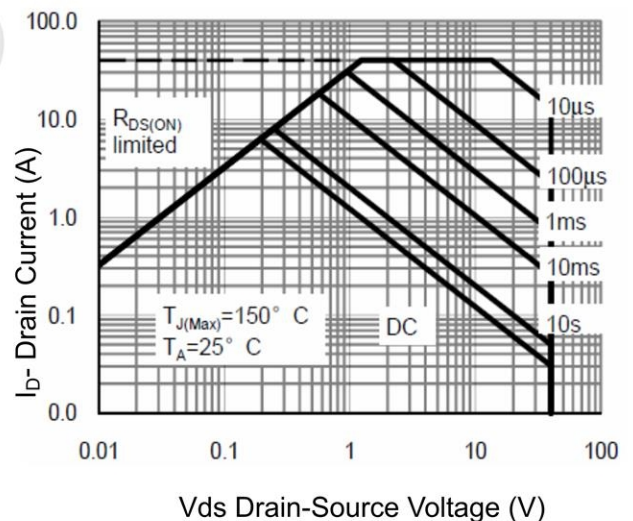

Figure 12 Safe Operation Area

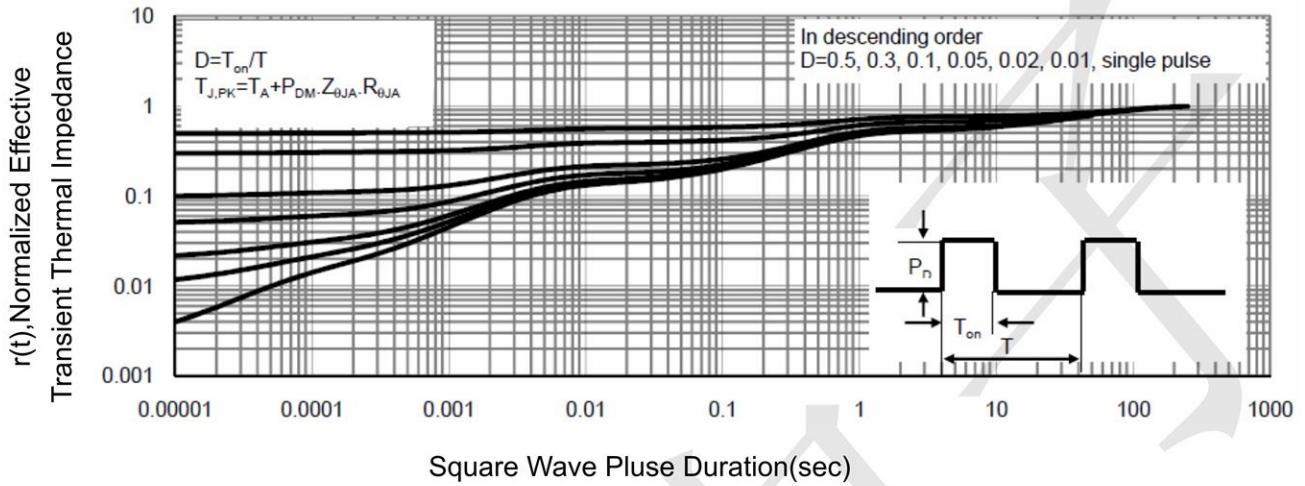

Figure 13 Normalized Maximum Transient Thermal Impedance



P- Channel Typical Electrical and Thermal Characteristics (Curves)

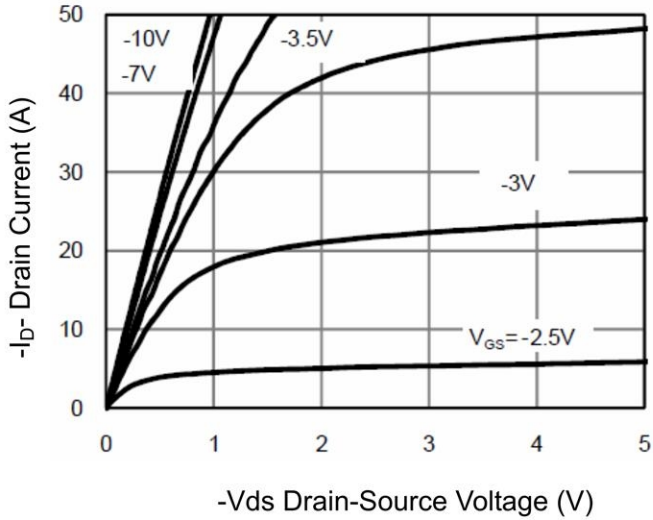

Figure 1 Output Characteristics

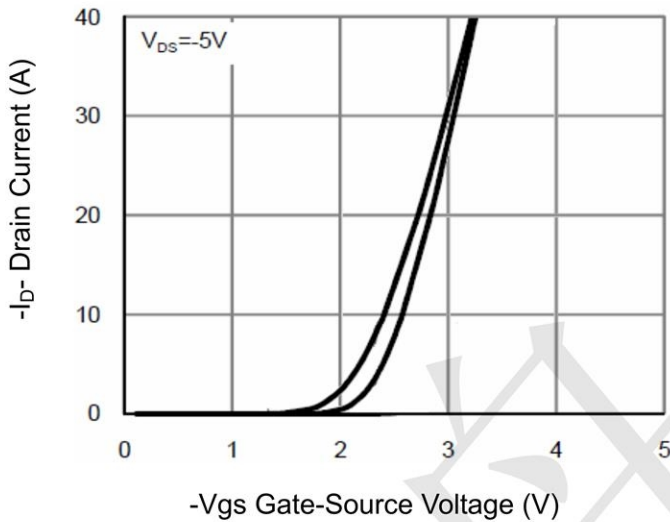

Figure 2 Transfer Characteristics

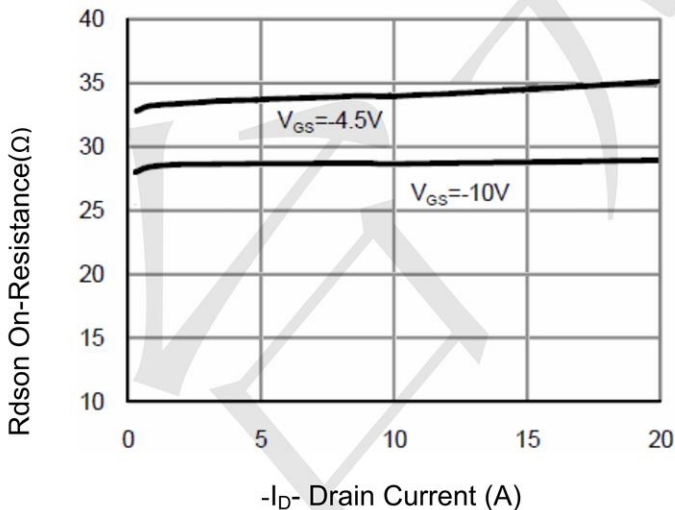

Figure 3 $R_{DS(on)}$ - Drain Current

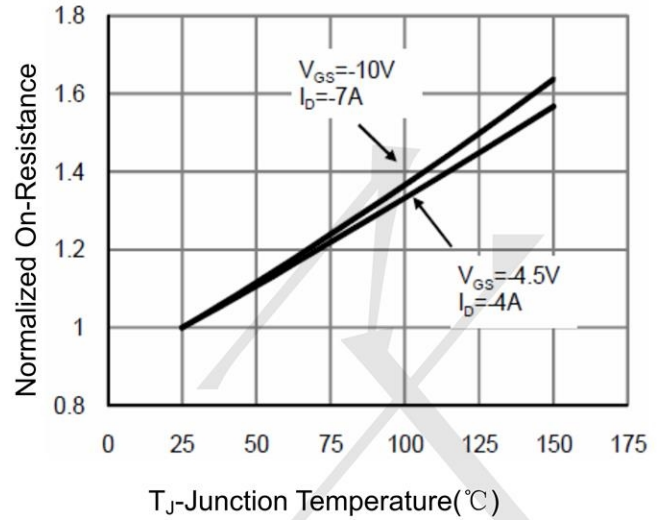

Figure 4 $R_{DS(on)}$ -Junction Temperature

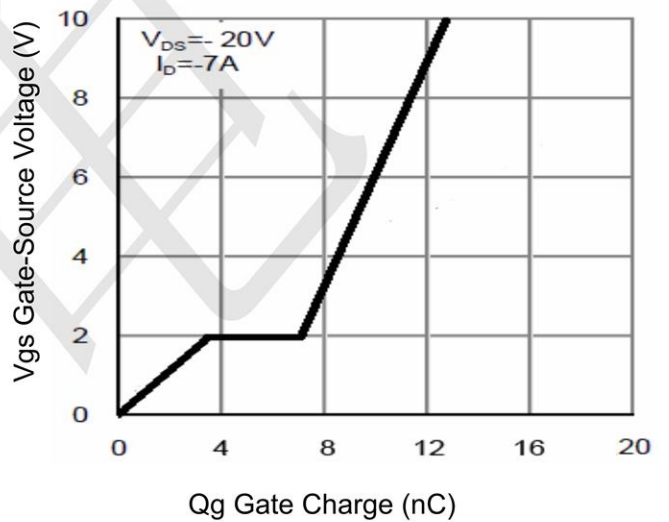

Figure 5 Gate Charge

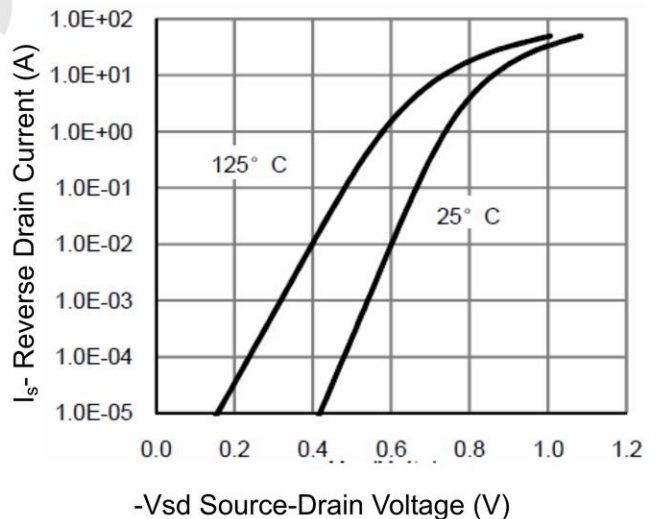

Figure 6 Source- Drain Diode Forward

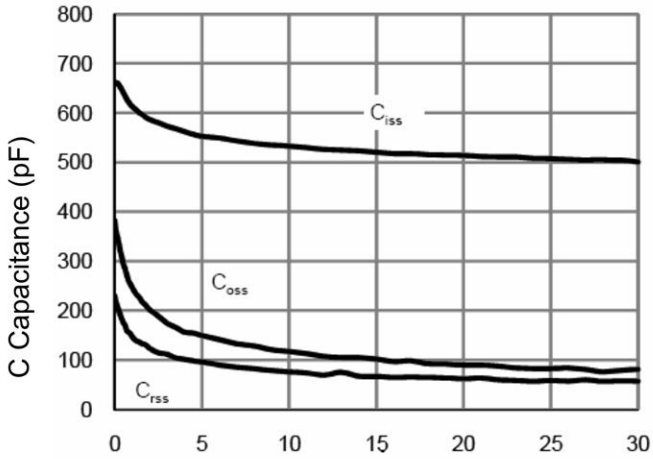

Figure 7 Capacitance vs Vds

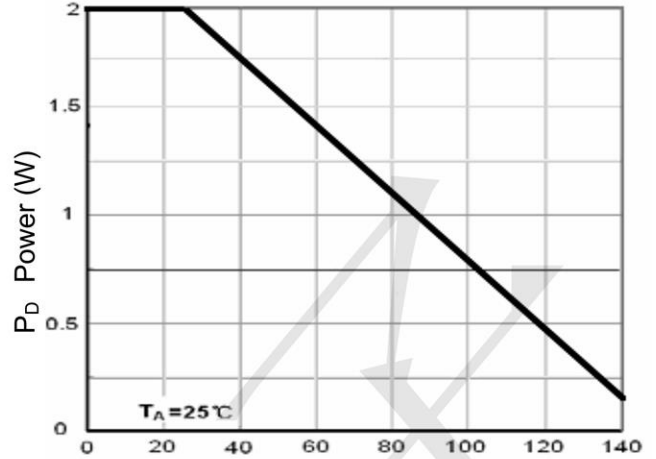

Figure 9 Power Dissipation

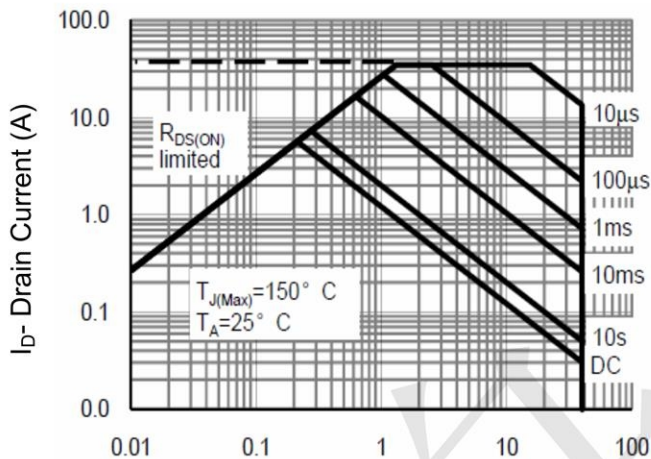

Figure 8 Safe Operation Area

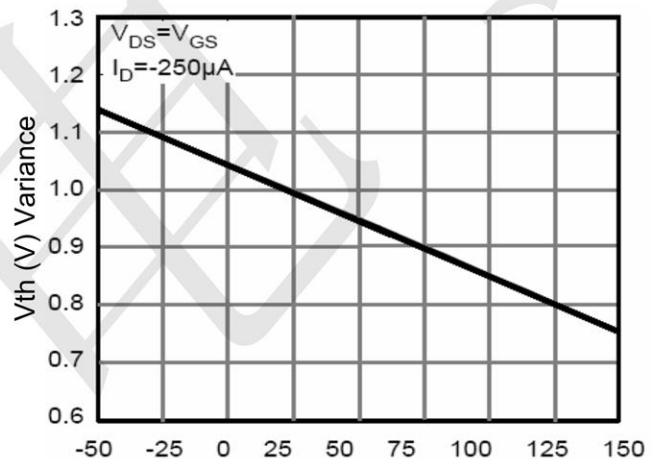

Figure 10 VGS(th) vs Junction Temperature

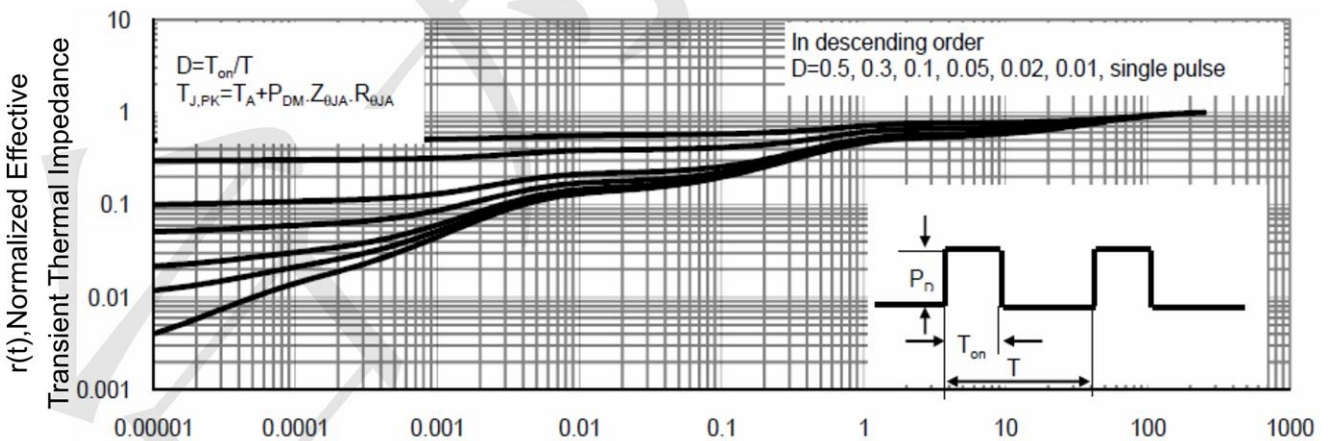
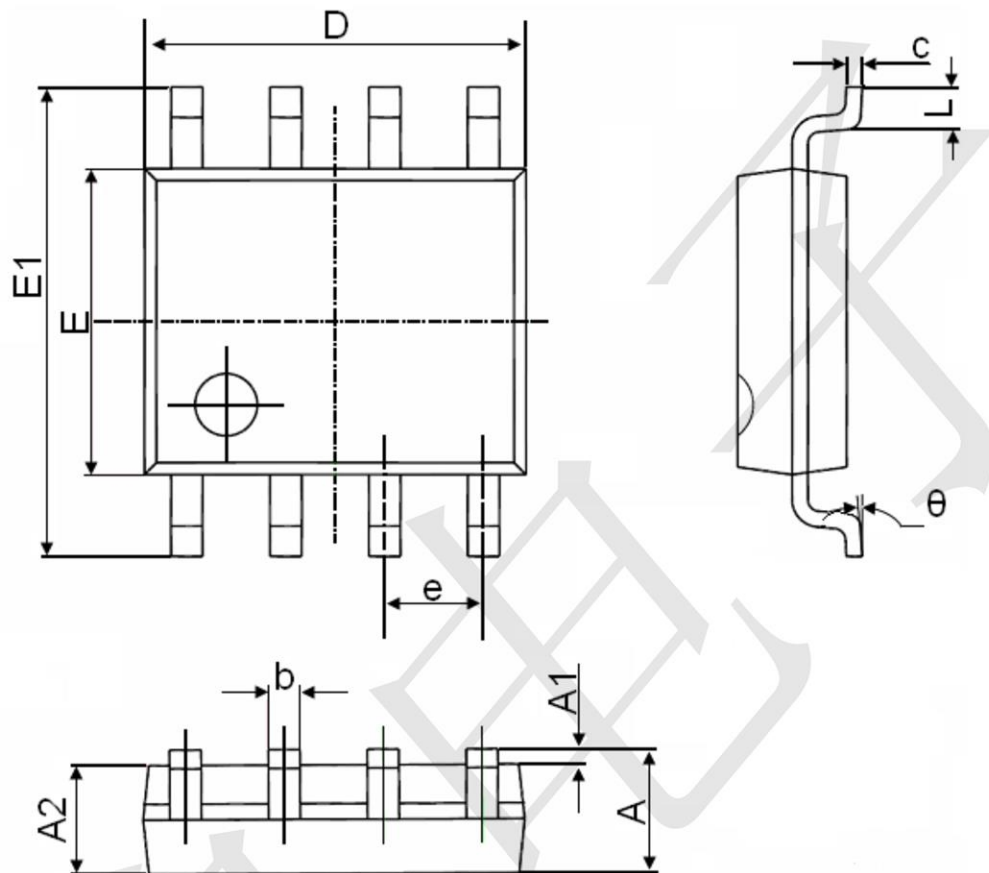

Figure 11 Normalized Maximum Transient Thermal Impedance



SOP-8 Package Information



| Symbol | Dimensions In Millimeters | | Dimensions In Inches | |
|----------|---------------------------|-------|----------------------|-------|
| | Min. | Max. | Min. | Max. |
| A | 1.350 | 1.750 | 0.053 | 0.069 |
| A1 | 0.100 | 0.250 | 0.004 | 0.010 |
| A2 | 1.350 | 1.550 | 0.053 | 0.061 |
| b | 0.330 | 0.510 | 0.013 | 0.020 |
| c | 0.170 | 0.250 | 0.006 | 0.010 |
| D | 4.700 | 5.100 | 0.185 | 0.200 |
| E | 3.800 | 4.000 | 0.150 | 0.157 |
| E1 | 5.800 | 6.200 | 0.228 | 0.244 |
| e | 1.270(BSC) | | 0.050(BSC) | |
| L | 0.400 | 1.270 | 0.016 | 0.050 |
| θ | 0° | 8° | 0° | 8° |

X-ON Electronics

Largest Supplier of Electrical and Electronic Components

Click to view similar products for [MOSFET](#) category:

Click to view products by [TECH PUBLIC](#) manufacturer:

Other Similar products are found below :

[MCH3443-TL-E](#) [MCH6422-TL-E](#) [NTNS3A92PZT5G](#) [IRFD120](#) [JANTX2N5237](#) [2N7000](#) [2SK2464-TL-E](#) [2SJ277-DL-E](#) [2SK2267\(Q\)](#)
[2SK2545\(Q,T\)](#) [405094E](#) [423220D](#) [MIC4420CM-TR](#) [VN1206L](#) [614234A](#) [715780A](#) [SSM6J414TU,LF\(T](#) [751625C](#) [IRS2092STRPBF-EL](#)
[IPS70R2K0CEAKMA1](#) [BSF024N03LT3 G](#) [PSMN4R2-30MLD](#) [TK31J60W5,S1VQ\(O](#) [2SK2614\(TE16L1,Q\)](#) [DMN1017UCP3-7](#)
[EFC2J004NUZTDG](#) [P85W28HP2F-7071](#) [DMN1053UCP4-7](#) [SQJ469EP-T1-GE3](#) [NTE2384](#) [NTE6400A](#) [DMC2700UDMQ-7](#)
[DMN2080UCB4-7](#) [DMN61D9UWQ-13](#) [US6M2GTR](#) [DMN31D5UDJ-7](#) [SSM6P54TU,LF](#) [DMP22D4UFO-7B](#) [IPS60R3K4CEAKMA1](#)
[DMN1006UCA6-7](#) [DMN16M9UCA6-7](#) [STF5N65M6](#) [IRF40H233XTMA1](#) [IPSA70R950CEAKMA1](#) [IPSA70R2K0CEAKMA1](#) [STU5N65M6](#)
[C3M0021120D](#) [DMN6022SSD-13](#) [DMN13M9UCA6-7](#) [MCQ4828A-TP](#)