

Features

Peak power dissipation 200W@10 x 1000 us Pluse
 Low incremental surge resistance
 Excellent clamping capability
 Glass passivated junction
 Fast response time
 Low leakage current
 Halogen free and RoHS compliant

Mechanical Data

CASE: SOD-123FL Molded Plastic
 Polarity: By cathode band denotes uni-directional device,
 none cathode band denotes bi-directional device
 Mounting Position:Any

Package	Packing Description	Packing Quantity
SOD-123FL	Tape/Reel,7" reel	3000
	Tape/Reel,13" reel	10000

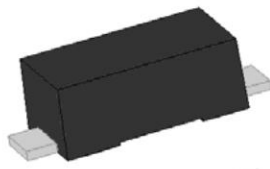

SOD-123FL

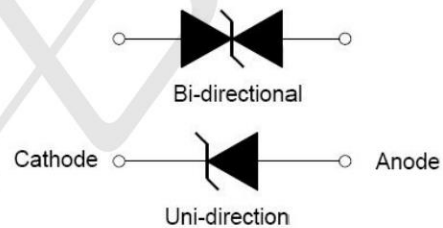

Maximum Ratings & Thermal Characteristics

(Ratings at 25°C ambient temperature unless otherwise specified.)

Parameter	Symbol	Value	Units	Remarks
Peak Pulse Power Dissipation	P_{PPM}	200	W	(Note1)(Note2)
Steady State Power Dissipation	P_D	1	W	(Note3)
Peak Forward Surge Current	I_{FSM}	20	A	(Note4)
Maximum Instantaneous Forward Voltage at 10A	V_{FM}	3.5	V	(Note5)
Typical Thermal Resistance Junction to Lead	$R_{\theta JL}$	100	°C/W	
Typical Thermal Resistance Junction to Ambient	$R_{\theta JA}$	220	°C/W	
Operating Temperature Range	T_J	-55 to 150	°C	
Storage Temperature Range	T_{STG}	-55 to 150	°C	

Notes1: Non-repetitive current pulse , 10/1000us Waveform.

Notes2: Mounted on copper pad area of 3×3mm to each terminal.

Notes3: Infinite HeatSink at $T_A=50^\circ\text{C}$

Notes4: Measured on 8.3ms single half sine wave or equivalent square wave, duty cycle=4 perminute maximum.

Notes5: For UnidirectionalOnly.

Electrical Characteristics

(Ratings at 25°C ambient temperature unless otherwise specified).

Part Number (Uni)	Part Number (Bi)	Marking Code		Reverse Stand off Voltage V_R (V)	Breakdown Voltage $V_{BR} @ I_T$ (V)		Test Current I_T (mA)	Maximum Clamping Voltage $V_C @ I_{PP}$ (V)	Maximum Peak Pulse Current I_{PP} (A)	Maximum Reverse Leakage $I_R @ V_R$ (μ A)
		Uni	Bi		Min	Max				
SMF5.0A	SMF5.0CA	5.0A	5.0CA	5	6.4	7	10	9.2	21.7	400
SMF6.0A	SMF6.0CA	6.0A	6.0CA	6	6.67	7.37	10	10.3	19.4	400
SMF6.5A	SMF6.5CA	6.5A	6.5CA	6.5	7.22	7.98	10	11.2	17.9	250
SMF7.0A	SMF7.0CA	7.0A	7.0CA	7	7.78	8.6	10	12	16.7	100
SMF7.5A	SMF7.5CA	7.5A	7.5CA	7.5	8.33	9.21	1	12.9	15.5	50
SMF8.0A	SMF8.0CA	8.0A	8.0CA	8	8.89	9.83	1	13.6	14.7	25
SMF8.5A	SMF8.5CA	8.5A	8.5CA	8.5	9.44	10.4	1	14.4	13.9	10
SMF9.0A	SMF9.0CA	9.0A	9.0CA	9	10	11.1	1	15.4	13	5
SMF10A	SMF10CA	10A	10CA	10	11.1	12.3	1	17	11.8	2.5
SMF11A	SMF11CA	11A	11CA	11	12.2	13.5	1	18.2	11	2.5
SMF12A	SMF12CA	12A	12CA	12	13.3	14.7	1	19.9	10.1	2.5
SMF13A	SMF13CA	13A	13CA	13	14.4	15.9	1	21.5	9.3	1
SMF14A	SMF14CA	14A	14CA	14	15.6	17.2	1	23.2	8.6	1
SMF15A	SMF15CA	15A	15CA	15	16.7	18.5	1	24.4	8.2	1
SMF16A	SMF16CA	16A	16CA	16	17.8	19.7	1	26	7.7	1
SMF17A	SMF17CA	17A	17CA	17	18.9	20.9	1	27.6	7.2	1
SMF18A	SMF18CA	18A	18CA	18	20	22.1	1	29.2	6.8	1
SMF20A	SMF20CA	20A	20CA	20	22.2	24.5	1	32.4	6.2	1
SMF22A	SMF22CA	22A	22CA	22	24.4	26.9	1	35.5	5.6	1
SMF24A	SMF24CA	24A	24CA	24	26.7	29.5	1	38.9	5.1	1
SMF26A	SMF26CA	26A	26CA	26	28.9	31.9	1	42.1	4.8	1
SMF28A	SMF28CA	28A	28CA	28	31.1	34.4	1	45.4	4.4	1
SMF30A	SMF30CA	30A	30CA	30	33.3	36.8	1	48.4	4.1	1
SMF33A	SMF33CA	33A	33CA	33	36.7	40.6	1	53.3	3.8	1
SMF36A	SMF36CA	36A	36CA	36	40	44.2	1	58.1	3.4	1
SMF40A	SMF40CA	40A	40CA	40	44.4	49.1	1	64.5	3.1	1
SMF43A	SMF43CA	43A	43CA	43	47.8	52.8	1	69.4	2.9	1
SMF45A	SMF45CA	45A	45CA	45	50	55.3	1	72.7	2.8	1
SMF48A	SMF48CA	48A	48CA	48	53.3	58.9	1	77.4	2.6	1
SMF51A	T[PSMF51CA	51A	51CA	51	56.7	62.7	1	82.4	2.4	1
SMF54A	SMF54CA	54A	54CA	54	60	66.3	1	87.1	2.3	1
SMF58A	SMF58CA	58A	58CA	58	64.4	71.2	1	93.6	2.1	1
SMF60A	SMF60CA	60A	60CA	60	66.7	73.7	1	96.8	1.8	1
SMF64A	SMF64CA	64A	64CA	64	71.1	78.6	1	103	1.7	1
SMF70A	SMF70CA	70A	70CA	70	77.8	86	1	113	1.5	1
SMF75A	SMF75CA	75A	75CA	75	83.3	92.1	1	121	1.4	1
SMF78A	SMF78CA	78A	78CA	78	86.7	95.8	1	126	1.4	1
SMF85A	SMF85CA	85A	85CA	85	94.4	104	1	137	1.3	1
SMF90A	SMF90CA	90A	90CA	90	100	111	1	146	1.2	1
SMF100A	SMF100CA	100	100C	100	111	123	1	162	1.1	1
SMF110A	SMF110CA	110	110C	110	122	135	1	177	1	1
SMF120A	SMF120CA	120	120C	120	133	147	1	193	0.9	1
SMF130A	SMF130CA	130	130C	130	144	159	1	209	0.8	1
SMF150A	SMF150CA	150	150C	150	167	185	1	243	0.7	1
SMF160A	SMF160CA	160	160C	160	178	197	1	259	0.7	1
SMF170A	SMF170CA	170	170C	170	189	209	1	275	0.6	1

Ratings and Characteristic Curves

(Ratings at 25°C ambient temperature unless otherwise specified).

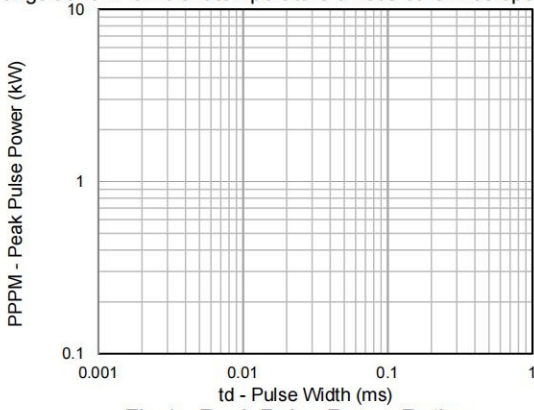

Fig.1 - Peak Pulse Power Rating

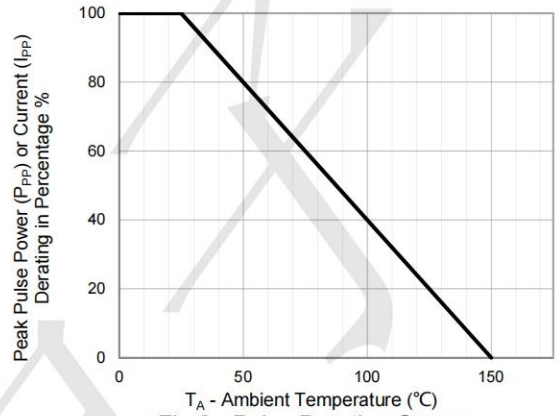

Fig.2 - Pulse Derating Curve

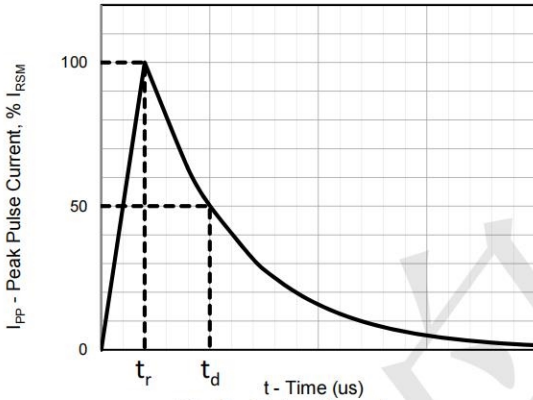

Fig.3 - Pulse Waveform

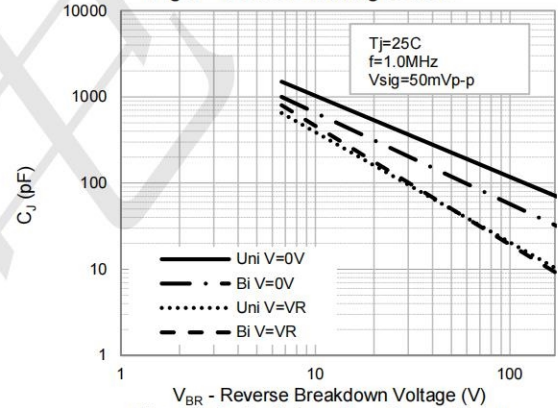

Fig.4 - Typical Junction Capacitance

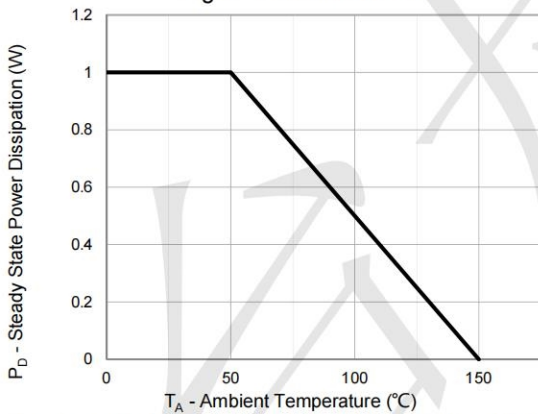

Fig.5 - Steady State Power Dissipation Derating Curve

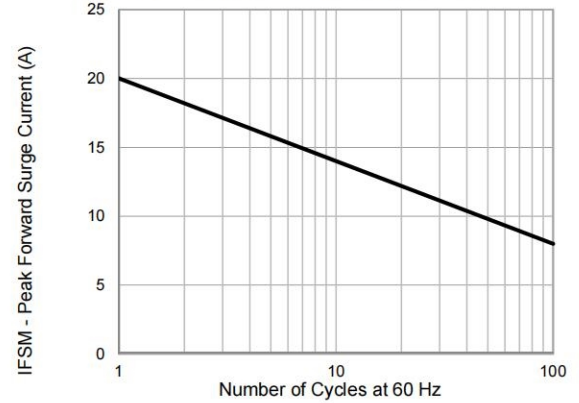
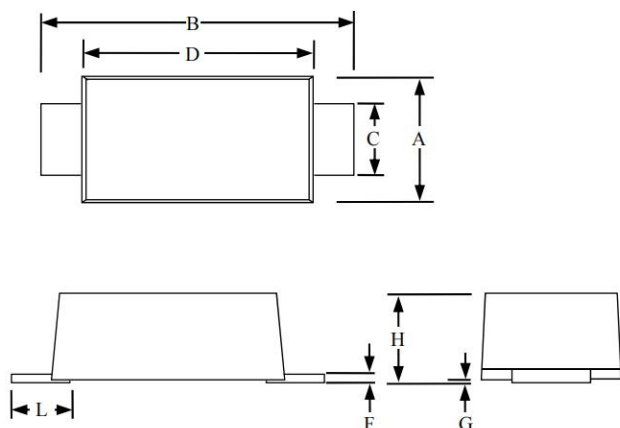

Fig.6 - Maximum Non-Repetitive Peak Forward Surge Current Uni-Directional Only

Package Outline Dimensions: SOD-123FL



SOD-123FL						
Dimension	Inches			Millimeters		
	MIN	NOM	MAX	MIN	NOM	MAX
A	0.059		0.079	1.5		2
B	0.134		0.154	3.4		3.9
C	0.028		0.047	0.7		1.2
D	0.098		0.114	2.5		2.9
F	0.002		0.01	0.05		0.26
G	-		0.004	-		0.1
H	0.037		0.053	0.95		1.35
L	0.014		0.035	0.35		0.9

X-ON Electronics

Largest Supplier of Electrical and Electronic Components

Click to view similar products for [ESD Suppressors / TVS Diodes](#) category:

Click to view products by [TECH PUBLIC](#) manufacturer:

Other Similar products are found below :

[60KS200C](#) [D18V0L1B2LP-7B](#) [D5V0F4U5P5-7](#) [DESD5V0U1BB-7](#) [NTE4902](#) [P4KE27CA](#) [P6KE11CA](#) [P6KE39CA-TP](#) [P6KE8.2A](#)
[SA110CA](#) [SA60CA](#) [SA64CA](#) [SMBJ12CATR](#) [SMBJ33CATR](#) [SMBJ8.0A](#) [ESD101-B1-02ELS E6327](#) [ESD105-B1-02EL E6327](#) [ESD112-B1-02EL E6327](#) [ESD119B1W01005E6327XTSA1](#) [ESD5V0L1B02VH6327XTSA1](#) [ESD7451N2T5G](#) [19180-510](#) [CPDT-5V0USP-HF](#)
[3.0SMCJ33CA-F](#) [3.0SMCJ36A-F](#) [HSPC16701B02TP](#) [D3V3Q1B2DLP3-7](#) [D55V0M1B2WS-7](#) [DESD5V0U1BL-7B](#) [DRTR5V0U4SL-7](#)
[SCM1293A-04SO](#) [ESD200-B1-CSP0201 E6327](#) [SM12-7](#) [SMF8.0A-TP](#) [SMLJ45CA-TP](#) [CEN955 W/DATA](#) [82350120560](#) [VESD12A1A-](#)
[HD1-GS08](#) [CPDUR5V0R-HF](#) [CPDQC5V0U-HF](#) [CPDQC5V0USP-HF](#) [CPDQC5V0-HF](#) [D1213A-01LP4-7B](#) [D1213A-02WL-7](#)
[1SMB33CAT3G-XYZ](#) [MMAD1108/TR13](#) [5KP100A](#) [5KP15A](#) [5KP18A](#) [5KP48A](#)