



Features

- Inputs and open-drain output accept voltage up to 5.5V
- Low power current: $I_{CC}=10\mu A(\text{Max})$
- $\pm 24\text{mA}$ output drive ($V_{CC}=3.3\text{V}$)
- Power down protection
- ESD Protection Exceeds JESD 22
 - 2000-V Human-Body Model (A114-A)
 - 1000-V Charged-Device Model (C101)
- SOT23-5 Package Available
- SOT353 Package Available
- SOT553 Package Available

General Description

The SN74LVC1G07 is a single Buffer/Driver with open-drain output. This device has power-down protective circuit, preventing device destruction when it is powered down.

Applications

- Voltage Level Shifting
- General Purpose Logic
- Power Down Signal Isolation
- Wide array of products such as:
 - PCs, Networking, Notebooks, Netbooks, PDAs
 - Tablet Computers, E-readers
 - Computer Peripherals, Hard Drives, CD/DVD ROM
 - TV, DVD, DVR, Set-Top Box
 - Cell Phones, Personal Navigation / GPS
 - MP3 Players, Cameras, Video Recorders

Ordering Information

ORDER NUMBER	PACKAGE DESCRIPTION	PACKAGE OPTION
SN74LVC1G07DBVR	SOT23-5	Tape and Reel,3000
SN74LVC1G07DCKR	SOT353	Tape and Reel,3000
SN74LVC1G07DRLR	SOT553	Tape and Reel,4000

Logic Diagram



Pin Configuration

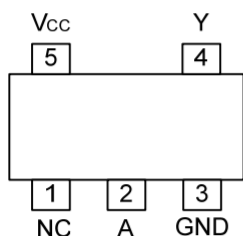

SOT23-5
SOT353
SOT553

Marking

SN74LVC1G07DBVR Marking:C07F
SN74LVC1G07DCKR Marking:CV5
SN74LVC1G07DRLR Marking:CV7

Function Table

INPUT(A)	OUTPUT(Y)
H	Z
L	L



Absolute Maximum Ratings

PARAMETER	SYMBOL	TEST CONDITIONS	RATINGS	UNIT
Supply Voltage	V_{CC}		-0.5 ~ 6.5	V
Input Voltage	V_{IN}		-0.5 ~ 6.5	V
Output Voltage	V_{OUT}	Active	-0.5 ~ 6.5	V
		Power-Down	-0.5 ~ 6.5	V
Continuous V_{CC} or GND Current	I_{CC}		±100	mA
Continuous Output Current	I_{OUT}		±50	mA
Input Clamp Current	I_{IK}	$V_{IN} < 0$	-50	mA
Output Clamp Current	I_{OK}	$V_{OUT} < 0$	-50	mA
Storage Temperature Range	T_{STG}		-65 ~ +150	°C

Note: Absolute maximum ratings are those values beyond which the device could be permanently damaged. Absolute maximum ratings are stress ratings only and functional device operation is not implied.

Recommended Operating Conditions

PARAMETER	SYMBOL	CONDITIONS	MIN	TYP	MAX	UNIT
Supply Voltage	V_{CC}	Operating	1.65		5.5	V
		Data retention only	1.5			V
Input Voltage	V_{IN}		0		5.5	V
Output Voltage	V_{OUT}		0		5.5	V
Operating Temperature	T_A		-40		+125	°C



Electrical Characteristics

PARAMETER	SYMBOL	TEST CONDITIONS	T _A =25°C			T _A =-40~+125°C			UNIT
			MIN	TYP	MAX	MIN	TYP	MAX	
High-Level Input Voltage	V _{IH}	V _{CC} =1.65V~1.95V	0.65× V _{CC}			0.65× V _{CC}			V
		V _{CC} =2.3V~2.7V	1.7			1.7			V
		V _{CC} =3.0V~3.6V	2			2			V
		V _{CC} =4.5V~5.5V	0.7× V _{CC}			0.7× V _{CC}			V
Low-Level Input Voltage	V _{IL}	V _{CC} =1.65V~1.95V			0.35× V _{CC}			0.35× V _{CC}	V
		V _{CC} =2.3V~2.7V			0.7			0.7	V
		V _{CC} =3.0V~3.6V			0.8			0.8	V
		V _{CC} =4.5V~5.5V			0.3× V _{CC}			0.3× V _{CC}	V
Low-Level Output Voltage	V _{OL}	V _{CC} =1.65V ~ 5.5V, I _{OL} =100μA			0.1			0.1	V
		V _{CC} =1.65V, I _{OL} =4mA			0.45			0.7	V
		V _{CC} =2.3V, I _{OL} =8mA			0.3			0.45	V
		V _{CC} =3.0V, I _{OL} =16mA			0.4			0.6	V
		V _{CC} =3.0V, I _{OL} =24mA			0.55			0.8	V
		V _{CC} =4.5V, I _{OL} =32mA			0.55			0.8	V
Input Leakage Current	I _{I(LEAK)}	V _{CC} =0V~5.5V, V _{IN} =V _{CC} or GND			±5			±5	μA
Power OFF Leakage Current	I _{OFF}	V _{CC} =0V, V _{IN} or V _{OUT} =5.5V			±10			±10	μA
OFF-state output current	I _{OZ}	V _{CC} =5.5V, V _{IN} =V _{IH} or V _{IL} , V _{OUT} =V _{CC} or GND		±0.1	±10			±10	μA
Quiescent Supply Current	I _Q	V _{CC} =1.65V~5.5V, V _{IN} =V _{CC} or GND, I _{OUT} =0			10			10	μA
Additional Quiescent Supply Current	ΔI _Q	V _{CC} =3V~5.5V, One input at V _{CC} -0.6V, other inputs at V _{CC} or GND			500			500	μA

Dynamic Characteristics (Input: t_R, t_F≤3ns; P_{RR}≤1MHz)

PARAMETER	SYMBOL	TEST CONDITIONS	T _A =25°C			T _A =-40~+125°C			UNIT
			MIN	TYP	MAX	MIN	TYP	MAX	
Propagation delay from input (A) to output(Y)	t _{PLZ} /t _{PZL}	V _{CC} =1.8V±0.15V, C _L =30pF, R _L =1KΩ	1		13.6	1		14	ns
		V _{CC} =2.5V±0.2V, C _L =30pF, R _L =500Ω	0.5		9.8	0.5		10	ns
		V _{CC} =3.3V±0.3V, C _L = 50 pF, R _L =500Ω	1		7.5	1		8	ns
		V _{CC} = 5V±0.5V, C _L = 50 pF, R _L =500Ω	0.5		6.6	0.5		7	ns

Operating Characteristics

PARAMETER	SYMBOL	TEST CONDITIONS	MIN	TYP	MAX	UNIT
Input Capacitance	C_{IN}	$V_{CC}=3.3V, V_{IN}=V_{CC}$ or GND		4		pF
Output Capacitance	C_{OUT}	$V_{CC}=3.3V, V_{OUT}=V_{CC}$ or GND		5		pF
Power Dissipation Capacitance	C_{PD}	$V_{CC}=1.8V$	3	3		pF
		$V_{CC}=2.5V$	3	3		pF
		$V_{CC}=3.3V$	3	4		pF
		$V_{CC}=5V$	3	6		pF

Test Circuit And Waveforms

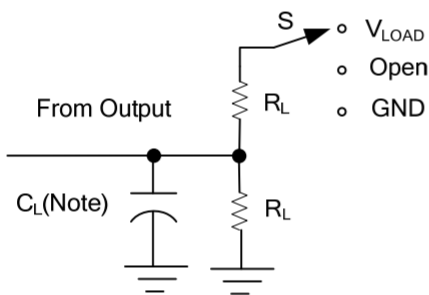

TEST	S
t_{PLH}/t_{PHL}	Open
t_{PHZ}/t_{PZH}	GND
t_{PLZ}/t_{PZL}	V_{LOAD}

Note: C_L includes probe and jig capacitance.

V_{CC}	V_{IN}	t_R / t_F	V_M	V_{LOAD}	C_L	R_L	V_{Δ}
$1.8V \pm 0.15V$	V_{CC}	$\leq 2ns$	$V_{CC}/2$	$2 \times V_{CC}$	30pF	1K Ω	0.15V
$2.5V \pm 0.2V$	V_{CC}	$\leq 2ns$	$V_{CC}/2$	$2 \times V_{CC}$	30pF	500 Ω	0.15V
$3.3V \pm 0.3V$	3 V	$\leq 2.5ns$	1.5V	6V	50pF	500 Ω	0.3V
$5V \pm 0.5V$	V_{CC}	$\leq 2.5ns$	$V_{CC}/2$	$2 \times V_{CC}$	50pF	500 Ω	0.3V

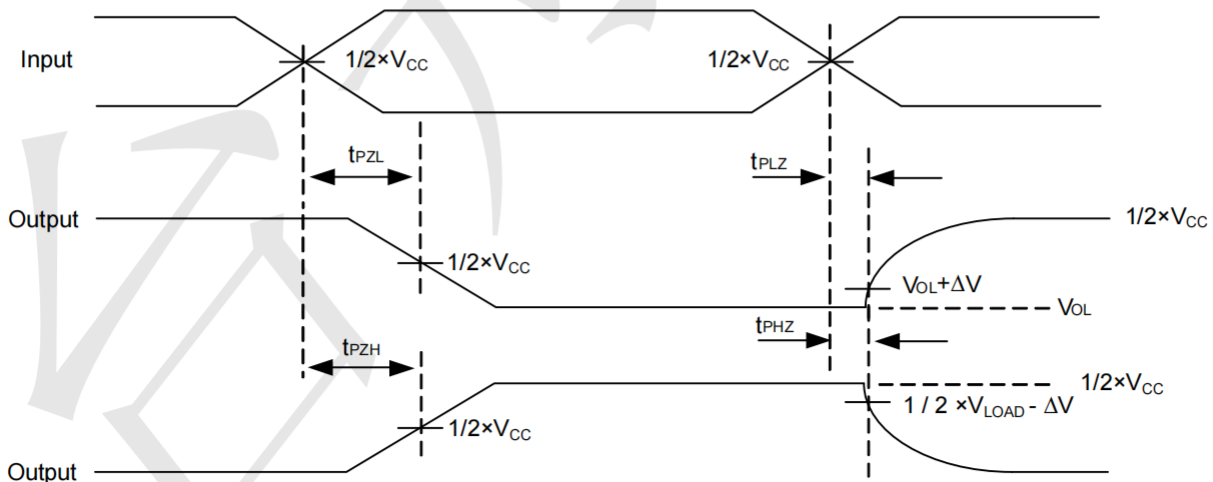



Package Outline Dimensions (Unit: mm)

SOT23-5



Dimension	Min.	Max.
A	2.80	3.00
B	1.50	1.70
C	1.00	1.20
D	0.35	0.45
E	0.35	0.55
F	1.80	2.00
G	0.90	1.00
H	0.02	0.10
J	0.10	0.20
K	2.60	3.00

Mounting Pad Layout (Unit: mm)

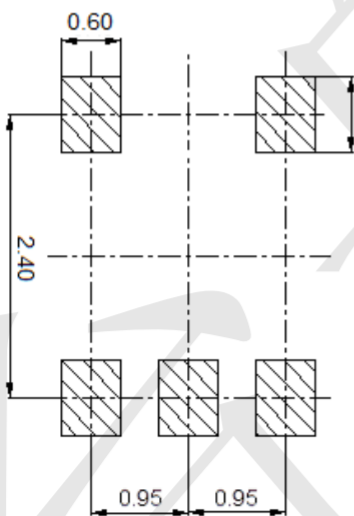



Package Outline Dimensions (Unit: mm)

SOT353



Dimension	Min.	Max.
A	2.00	2.20
B	1.15	1.35
C	0.85	1.05
D	0.15	0.35
E	0.25	0.40
F	1.20	1.40
G	0.60	0.70
H	0.02	0.10
J	0.05	0.15
K	2.20	2.40

Mounting Pad Layout (Unit: mm)

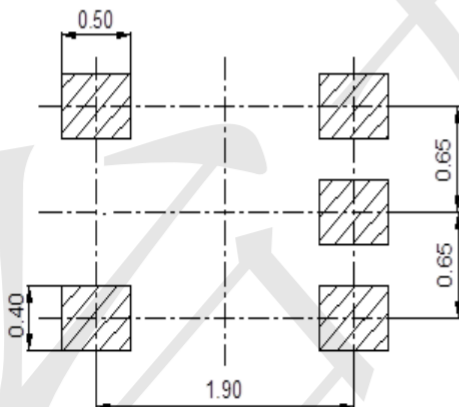



Package Outline Dimensions (Unit: mm)

SOT553

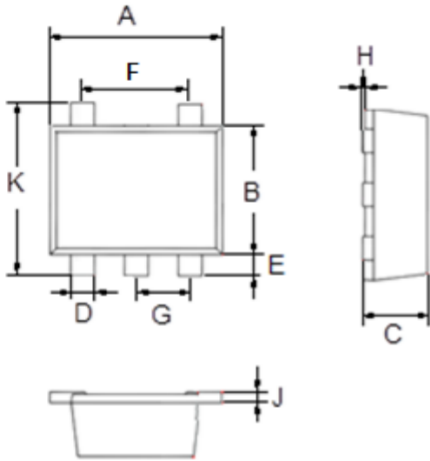

Dimension	Min.	Max.
A	1.500	1.700
B	1.100	1.300
C	0.525	0.600
D	0.170	0.270
E	0.100	0.300
F	0.400	0.600
G	0.450	0.550
H	0.000	0.050
J	0.090	0.160
K	1.500	1.700

Mounting Pad Layout (Unit: mm)

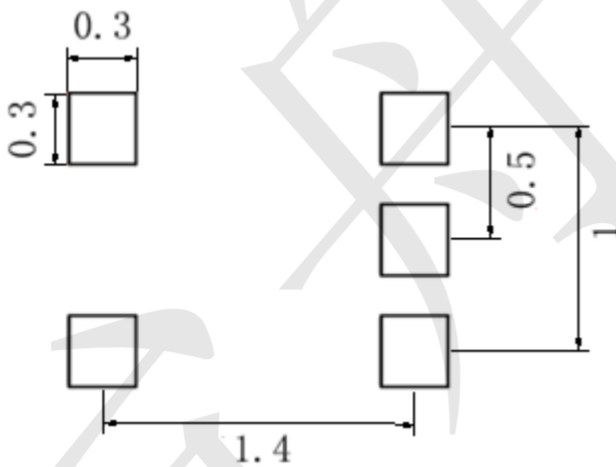

X-ON Electronics

Largest Supplier of Electrical and Electronic Components

Click to view similar products for [Logic Gates](#) category:

Click to view products by [TECH PUBLIC](#) manufacturer:

Other Similar products are found below :

[NL17SG32DFT2G](#) [CD4068BE](#) [NL17SG86DFT2G](#) [NLX1G11AMUTCG](#) [NLX1G97MUTCG](#) [74LS38](#) [74LVC1G08Z-7](#) [CD4025BE](#)
[NLV17SZ00DFT2G](#) [NLV17SZ126DFT2G](#) [NLV27WZ17DFT2G](#) [NLV74HC02ADR2G](#) [74HC32S14-13](#) [74LS133](#) [74LVC1G32Z-7](#)
[74LVC1G86Z-7](#) [NLV74HC14ADR2G](#) [NLV74HC20ADR2G](#) [NLVVHC1G09DFT1G](#) [NLX2G86MUTCG](#) [74LVC2G32RA3-7](#)
[74LVC2G00HD4-7](#) [NL17SG02P5T5G](#) [74LVC2G86HK3-7](#) [NLVVHC1G14DFT2G](#) [NLX1G99DMUTWG](#) [NLVVHC1G00DFT2G](#)
[NLV7SZ57DFT2G](#) [NLV74VHC04DTR2G](#) [NLV27WZ00USG](#) [NLU1G86CMUTCG](#) [NLU1G08CMUTCG](#) [NL17SZ32P5T5G](#)
[NL17SZ00P5T5G](#) [NL17SH02P5T5G](#) [74AUP2G00RA3-7](#) [NLVVHC1GT00DFT2G](#) [NLV74HC02ADTR2G](#) [NLX1G332CMUTCG](#)
[NLVHCT132ADTR2G](#) [NL17SG86P5T5G](#) [NL17SZ05P5T5G](#) [NLV74VHC00DTR2G](#) [NLVVHC1G02DFT1G](#) [NLV74HC86ADR2G](#)
[74LVC2G86RA3-7](#) [NL17SZ38DBVT1G](#) [NLV18SZ00DFT2G](#) [NLVVHC1G07DFT1G](#) [NLVVHC1G02DFT2G](#)