

Features

- Operate from 1.65V to 5.5V
- Inputs accept voltages to 5.5V
- I_{OFF} supports partial-power-down mode
- Low power dissipation
- Max t_{PD} of 4 ns at 3.3V
- SOT23-5 Package Available
- SOT353 Package Available
- SOT553 Package Available

General Description

The SN74LVC1G86 is a single 2-input EXCLUSIVE-OR gate which provides the Function $Y = A \oplus B$ or $Y = \overline{A}B + A\overline{B}$ in positive logic. Inputs can be driven from either 3.3V or 5V devices. These features allow the use of these devices in a mixed 3.3V and 5V environment.

This device is fully specified for partial Power-down applications using I_{OFF}. The I_{OFF} circuitry disables the output, preventing the damaging backflow current through the device when it is powered down.

Ordering Information

ORDER NUMBER	PACKAGE DESCRIPTION	PACKAGE OPTION
SN74LVC1G86DBVR	SOT23-5	Tape and Reel,3000
SN74LVC1G86DCKR	SOT353	Tape and Reel,3000
SN74LVC1G86DRLR	SOT553	Tape and Reel,4000

Logic Diagram

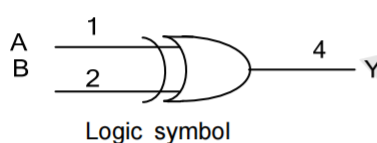

Pin Configuration

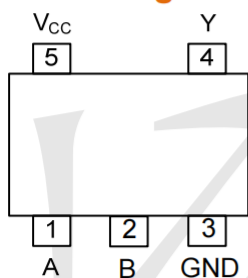

SOT23-5
SOT353
SOT553

Applications

- Voltage Level Shifting
- General Purpose Logic
- Power Down Signal Isolation
- Wide array of products such as:
 - PCs, Networking, Notebooks, Netbooks, PDAs
 - Tablet Computers, E-readers
 - Computer Peripherals, Hard Drives, CD/DVD ROM
 - TV, DVD, DVR, Set-Top Box
 - Cell Phones, Personal Navigation / GPS
 - MP3 Players, Cameras, Video Recorders

Function Table

INPUT(A)	INPUT(B)	OUTPUT(Y)
L	L	L
H	L	H
L	H	H
H	H	L

Note: H: HIGH voltage level; L: LOW voltage level

Marking

SN74LVC1G86DBVR Marking:C86F

SN74LVC1G86DCKR Marking:CH5

SN74LVC1G86DRLR Marking:CH7



Absolute Maximum Ratings

PARAMETER		SYMBOL	RATINGS	UNIT
Supply Voltage		V_{CC}	-0.5 ~ +6.5	V
Input Voltage		V_{IN}	-0.5 ~ +6.5	V
Output Voltage	Output in the high or low state	V_{OUT}	-0.5 ~ $V_{CC}+0.5$	V
	Output in the high-impedance or power-off state		-0.5 ~ +6.5	V
Continuous V_{CC} or GND Current		I_{CC}	±100	mA
Continuous Output Current ($V_{OUT}=0$ to V_{CC})		I_{OUT}	±50	mA
Input Clamp Current ($V_{IN}<0$)		I_{IK}	-50	mA
Output Clamp Current ($V_{OUT}<0$)		I_{OK}	-50	mA
Storage Temperature Range		T_{STG}	-65 ~ +150	°C

Note: Absolute maximum ratings are those values beyond which the device could be permanently damaged. Absolute maximum ratings are stress ratings only and functional device operation is not implied.

Recommended Operating Conditions

PARAMETER	SYMBOL	TEST CONDITIONS	MIN	TYP	MAX	UNIT
Supply Voltage	V_{CC}	Operating	1.65		5.5	V
		Data retention only	1.5			V
Input Voltage	V_{IN}		0		5.5	V
Output Voltage	V_{OUT}	High or low state	0		V_{CC}	V
High-level Output Current	I_{OH}	$V_{CC}=1.65V$			-4	mA
		$V_{CC}=2.3V$			-8	mA
		$V_{CC}=3V$			-16	mA
		$V_{CC}=3V$			-24	mA
		$V_{CC}=4.5V$			-32	mA
Low-level Output Current	I_{OL}	$V_{CC}=1.65V$			4	mA
		$V_{CC}=2.3V$			8	mA
		$V_{CC}=3V$			16	mA
		$V_{CC}=3V$			24	mA
		$V_{CC}=4.5V$			32	mA
Input Transition Rise or Fall Rate	$\Delta t/\Delta v$	$V_{CC}=1.8V\pm 0.15V, 2.5V\pm 0.2V$			20	ns/V
		$V_{CC}=3.3V\pm 0.3V$			10	ns/V
		$V_{CC}=5V\pm 0.5V$			5	ns/V
Operating Temperature	T_A		-40		+125	°C

Electrical Characteristics

PARAMETER	SYMBOL	TEST CONDITIONS	MIN	TYP	MAX	UNIT	
High-level Input Voltage	V_{IH}	$V_{CC}=1.65V$ to $1.95V$	$0.65 \times V_{CC}$			V	
		$V_{CC}=2.3V$ to $2.7V$	1.7			V	
		$V_{CC}=3V$ to $3.6V$	2			V	
		$V_{CC}=4.5V$ to $5.5V$	$0.7 \times V_{CC}$			V	
Low-level Input Voltage	V_{IL}	$V_{CC}=1.65V$ to $1.95V$			$0.35 \times V_{CC}$	V	
		$V_{CC}=2.3V$ to $2.7V$			0.7	V	
		$V_{CC}=3V$ to $3.6V$			0.8	V	
		$V_{CC}=4.5V$ to $5.5V$			$0.3 \times V_{CC}$	V	
High-Level Output Voltage	V_{OH}	$V_{CC}=1.65 \sim 5.5V$, $I_{OH}=-100\mu A$	$V_{CC}-0.1$			V	
		$V_{CC}=1.65V$, $I_{OH}=-4mA$	1.2			V	
		$V_{CC}=2.3V$, $I_{OH}=-8mA$	1.9			V	
		$V_{CC}=3.0V$	$I_{OH}=-16mA$	2.4			V
		$I_{OH}=-24mA$	2.3			V	
Low-Level Output Voltage	V_{OL}	$V_{CC}=1.65 \sim 5.5V$, $I_{OL}=100\mu A$			0.1	V	
		$V_{CC}=1.65V$, $I_{OL}=4mA$			0.45	V	
		$V_{CC}=2.3V$, $I_{OL}=8mA$			0.3	V	
		$V_{CC}=3.0V$	$I_{OL}=16mA$			0.4	V
		$I_{OL}=24mA$			0.55	V	
$V_{CC}=4.5V$, $I_{OL}=32mA$			0.55	V			
Input Leakage Current	$I_{(LEAK)}$	$V_{CC}=0 \sim 5.5V$, $V_{IN}=5.5V$ or GND			± 5	μA	
Power OFF Leakage Current	I_{off}	$V_{CC}=0V$, V_{IN} or $V_{OUT}=5.5V$			± 10	μA	
Quiescent Supply Current	I_{CC}	$V_{CC}=1.65 \sim 5.5V$, $V_{IN}=V_{CC}$ or GND, $I_{OUT}=0$			10	μA	
Additional Quiescent Supply Current Per Input Pin	ΔI_{CC}	$V_{CC}=3 \sim 5.5V$, One input at $V_{CC}-0.6V$, Other inputs at V_{CC} or GND			500	μA	
Input Capacitance	C_I	$V_{CC}=3.3V$, $V_{IN}=V_{CC}$ or GND		6		pF	

Dynamic Characteristics (Input: $t_R, t_F \leq 3ns$; $P_{RR} \leq 1MHz$)

PARAMETER	SYMBOL	TEST CONDITIONS	MIN	TYP	MAX	UNIT
Propagation delay from input to output	t_{PLH} t_{PHL}	$V_{CC}=1.8 \pm 0.15V$, $C_L=15pF$, $R_L=1M\Omega$	2.1		9.1	ns
		$V_{CC}=2.5 \pm 0.2V$, $C_L=15pF$, $R_L=1M\Omega$	1		4.5	ns
		$V_{CC}=3.3 \pm 0.3V$, $C_L=15pF$, $R_L=1M\Omega$	0.6		4	ns
		$V_{CC}=5 \pm 0.5V$, $C_L=15pF$, $R_L=1M\Omega$	0.8		3.3	ns
Propagation delay from input to output	t_{PLH} t_{PHL}	$V_{CC}=1.8 \pm 0.15V$, $C_L=30pF$, $R_L=1K\Omega$	3.5		9.9	ns
		$V_{CC}=2.5 \pm 0.2V$, $C_L=30pF$, $R_L=500\Omega$	1.8		5.5	ns
		$V_{CC}=3.3 \pm 0.3V$, $C_L=50pF$, $R_L=500\Omega$	1.3		5	ns
		$V_{CC}=5 \pm 0.5V$, $C_L=50pF$, $R_L=500\Omega$	1		4	ns



Operating Characteristics

PARAMETER	SYMBOL	TEST CONDITIONS	MIN	TYP	MAX	UNIT
Power Dissipation Capacitance	C_{PD}	$V_{CC}=1.8V$		22		pF
		$V_{CC}=2.5V$		22		pF
		$V_{CC}=3.3V$		22		pF
		$V_{CC}=5V$		24		pF

Test Circuit And Waveforms

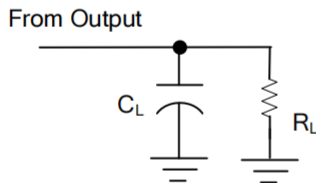

TEST CIRCUIT

V_{CC}	Inputs		V_M	C_L	R_L
	V_{IN}	t_R, t_F			
$1.8V \pm 0.15V$	V_{CC}	$\leq 2ns$	$V_{CC}/2$	15pF	1M Ω
				30pF	1K Ω
$2.5V \pm 0.2V$	V_{CC}	$\leq 2ns$	$V_{CC}/2$	15pF	1M Ω
				30pF	500 Ω
$3.3V \pm 0.3V$	3V	$\leq 2.5ns$	1.5V	15pF	1M Ω
				50pF	500 Ω
$5V \pm 0.5V$	V_{CC}	$\leq 2.5ns$	$V_{CC}/2$	15pF	1M Ω
				50pF	500 Ω

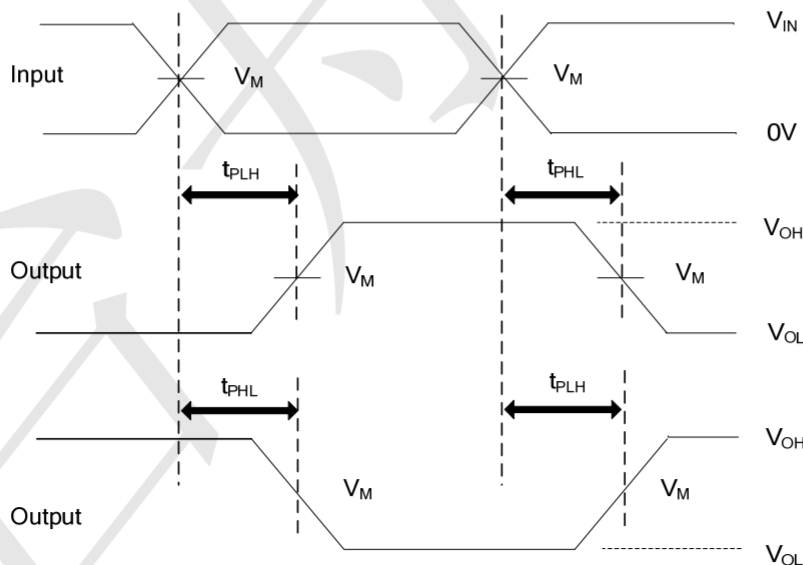

PROPAGATION DELAY TIMES



Package Outline Dimensions (Unit: mm)

SOT23-5

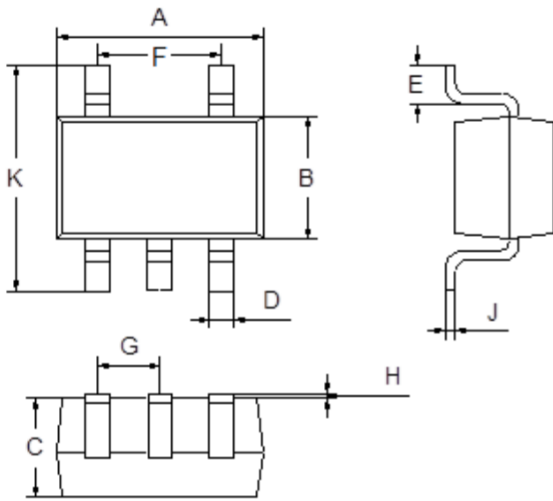

Dimension	Min.	Max.
A	2.80	3.00
B	1.50	1.70
C	1.00	1.20
D	0.35	0.45
E	0.35	0.55
F	1.80	2.00
G	0.90	1.00
H	0.02	0.10
J	0.10	0.20
K	2.60	3.00

Mounting Pad Layout (Unit: mm)

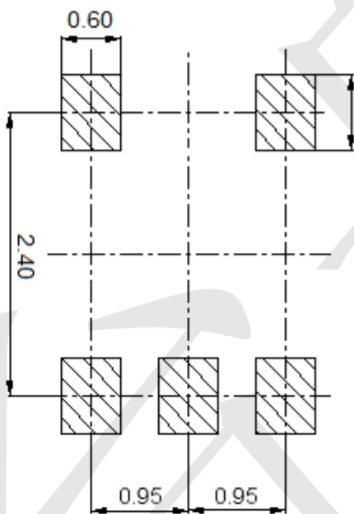



Package Outline Dimensions (Unit: mm)

SOT353

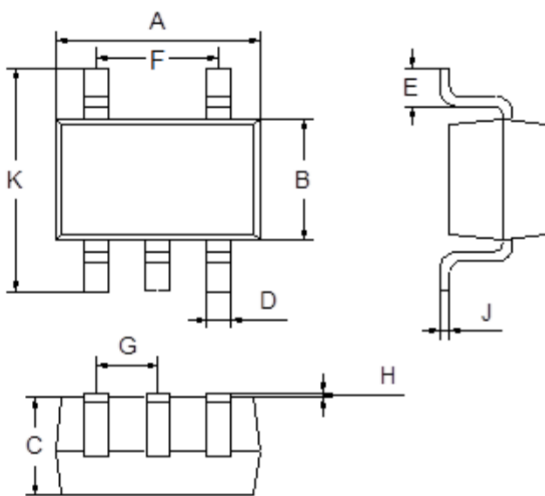

Dimension	Min.	Max.
A	2.00	2.20
B	1.15	1.35
C	0.85	1.05
D	0.15	0.35
E	0.25	0.40
F	1.20	1.40
G	0.60	0.70
H	0.02	0.10
J	0.05	0.15
K	2.20	2.40

Mounting Pad Layout (Unit: mm)

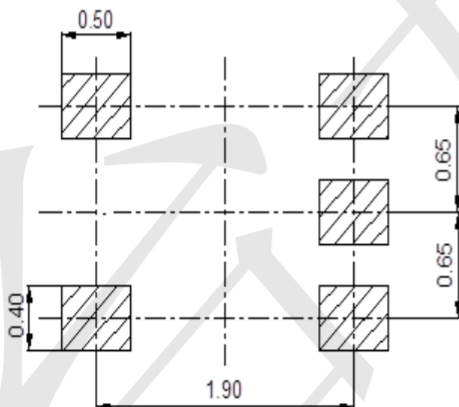



Package Outline Dimensions (Unit: mm)

SOT553

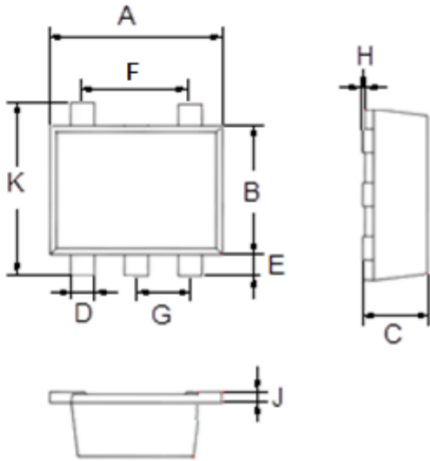

Dimension	Min.	Max.
A	1.500	1.700
B	1.100	1.300
C	0.525	0.600
D	0.170	0.270
E	0.100	0.300
F	0.400	0.600
G	0.450	0.550
H	0.000	0.050
J	0.090	0.160
K	1.500	1.700

Mounting Pad Layout (Unit: mm)

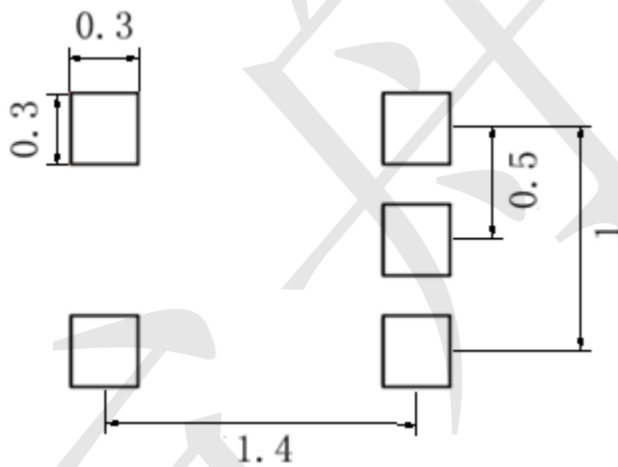

X-ON Electronics

Largest Supplier of Electrical and Electronic Components

Click to view similar products for [Logic Gates](#) category:

Click to view products by [TECH PUBLIC](#) manufacturer:

Other Similar products are found below :

[74HC85N](#) [NL17SG32DFT2G](#) [CD4068BE](#) [NL17SG86DFT2G](#) [NLX1G11AMUTCG](#) [NLX1G97MUTCG](#) [74LS38](#) [74LVC1G08Z-7](#)
[CD4025BE](#) [NLV17SZ00DFT2G](#) [NLV17SZ126DFT2G](#) [NLV27WZ17DFT2G](#) [NLV74HC02ADR2G](#) [74HC32S14-13](#) [74LS133](#)
[74LVC1G32Z-7](#) [74LVC1G86Z-7](#) [NLV74HC14ADR2G](#) [NLV74HC20ADR2G](#) [NLVVHC1G09DFT1G](#) [NLX2G86MUTCG](#)
[74LVC2G32RA3-7](#) [74LVC2G00HD4-7](#) [NL17SG02P5T5G](#) [74LVC2G86HK3-7](#) [NLVVHC1G14DFT2G](#) [NLX1G99DMUTWG](#)
[NLVVHC1G00DFT2G](#) [NLV7SZ57DFT2G](#) [NLV74VHC04DTR2G](#) [NLV27WZ00USG](#) [NLU1G86CMUTCG](#) [NLU1G08CMUTCG](#)
[NL17SZ32P5T5G](#) [NL17SZ00P5T5G](#) [NL17SH02P5T5G](#) [74AUP2G00RA3-7](#) [NLVVHC1GT00DFT2G](#) [NLV74HC02ADTR2G](#)
[NLX1G332CMUTCG](#) [NLVHCT132ADTR2G](#) [NL17SG86P5T5G](#) [NL17SZ05P5T5G](#) [NLV74VHC00DTR2G](#) [NLVVHC1G02DFT1G](#)
[NLV74HC86ADR2G](#) [74LVC2G32HK3-7](#) [74LVC2G86RA3-7](#) [NL17SZ38DBVT1G](#) [NLV18SZ00DFT2G](#)