

Features

- * 350W peak pulse power (8/20 μ s)
- * Low operating :5V
- * Ultra low capacitance: 0.6 pF typical
- * Ultra low leakage: nA level
- * Low clamping voltage
- * Protects one power line or data line
- * Complies with following standards:
 - IEC 61000-4-2 (ESD) immunity test
Air discharge: \pm 30kV
Contact discharge: \pm 30kV
 - IEC61000-4-4 (EFT) 40A (5/50ns)
- * RoHS Compliant

Mechanical Characteristics

- * Package: SOD-323
- * Ultra low leakage: nA level
- * Case Material: “Green” Molding Compound.
- * UL Flammability Classification Rating 94V-0
- * Moisture Sensitivity: Level 3 per J-STD-020
- * Shipping Qty :3000pcs/7Inch Tape & Reel

Applications

- * Cellular Handsets and Accessories
- * Personal Digital Assistants
- * Notebooks and Handhelds
- * Portable Instrumentation
- * Peripherals

Dimensions and Pin Configuration

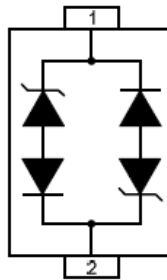

Marking:AC

Absolute Maximum Ratings (Tamb=25°C unless otherwise specified)

Parameter	Symbol	Value	Unit
ESD per IEC 61000-4-2 (Air)	VESD	±30	kV
ESD per IEC 61000-4-2 (Contact)		±30	
Operating Temperature Range	TJ	-55 to +125	°C
Storage Temperature Range	Tstg	-55 to +150	°C

Electrical Characteristics (TA=25°C unless otherwise specified)

Symbol	Parameter
V _{RWM}	Nominal Reverse Working Voltage
I _R	Reverse Leakage Current @ V _{RWM}
V _{BR}	Reverse Breakdown Voltage @ I _T
I _T	Test Current for Reverse Breakdown
V _C	Clamping Voltage @ I _{PP}
I _{PP}	Maximum Peak Pulse Current
C _{ESD}	Parasitic Capacitance
V _R	Reverse Voltage
f	Small Signal Frequency

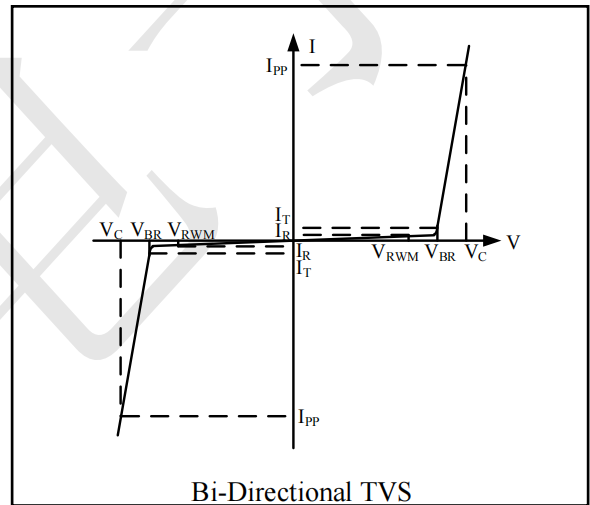

Parameter	Symbol	Test Condition	Min	Typ	Max	Unit
Reverse Working Voltage	V _{RWM}				5	V
Breakdown Voltage	V _{BR}	I _T = 1mA	6			V
Reverse Leakage Current	I _R	V _{RWM} = 5V			0.2	μA
Clamping Voltage	V _C	I _{PP} = 1A (8 x 20μs pulse)			9	V
Clamping Voltage	V _C	I _{PP} = 18A (8 x 20us pulse)			20	V
Junction Capacitance	C _J	V _R = 0V, f = 1MHz		0.6		pF

Electrical Characteristics ($T_A=25^\circ\text{C}$ unless otherwise specified)

Fig1. 8/20 μs Pulse Waveform

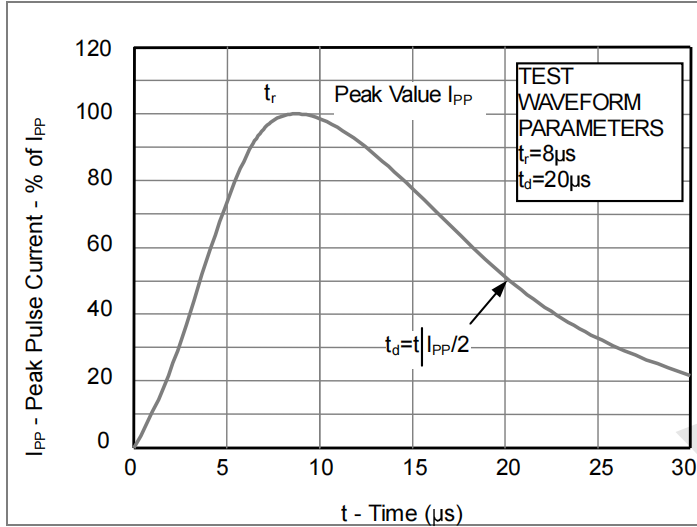

Fig2. ESD Pulse Waveform (according to IEC 61000-4-2)

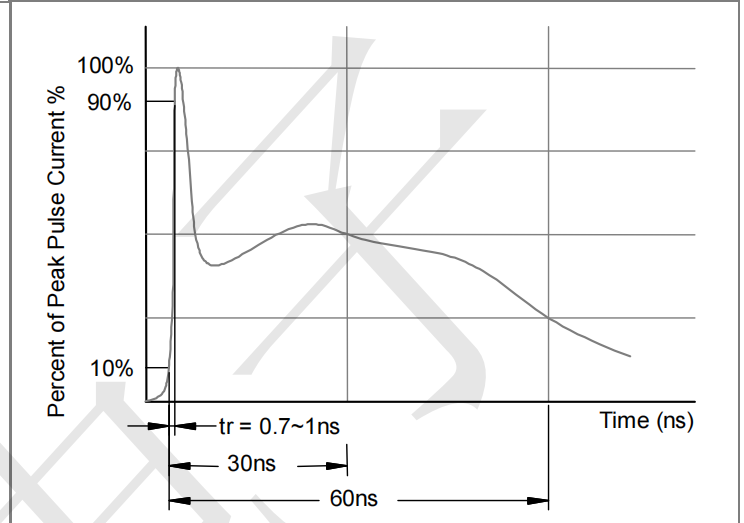
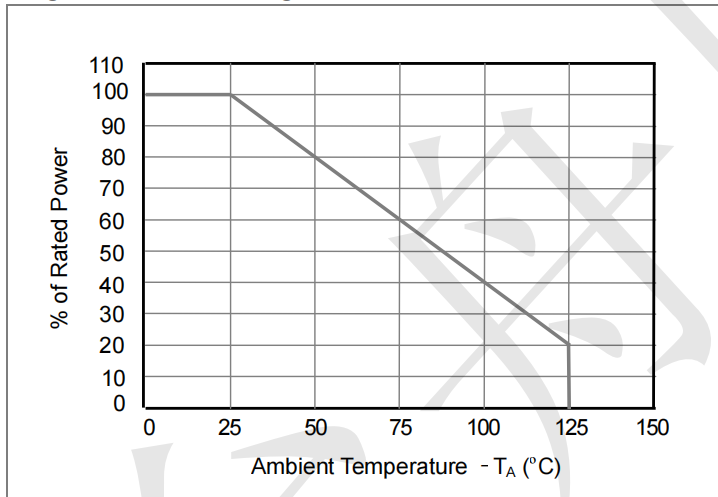
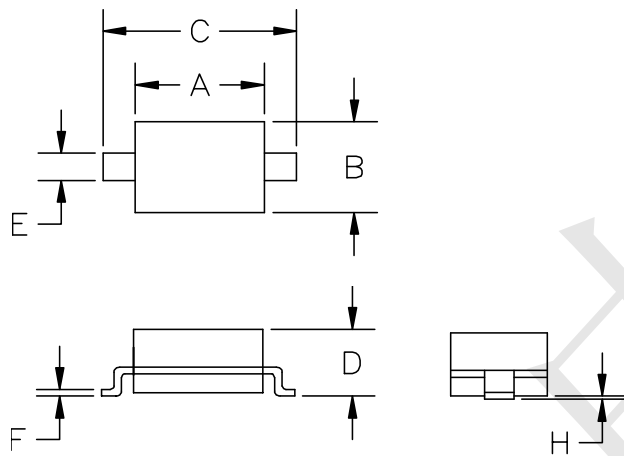

Fig3. Power Derating Curve



Outline Drawing - SOD-323



SYM	DIMENSIONS			
	MILLIMETERS		INCHES	
	MIN	MAX	MIN	MAX
A	1.50	1.80	0.060	0.071
B	1.20	1.40	0.045	0.054
C	2.30	2.70	0.090	0.107
D	-	1.10	-	0.043
E	0.30	0.40	0.012	0.016
F	0.10	0.25	0.004	0.010
H	-	0.10	-	0.004

Land Pattern - SOD-323

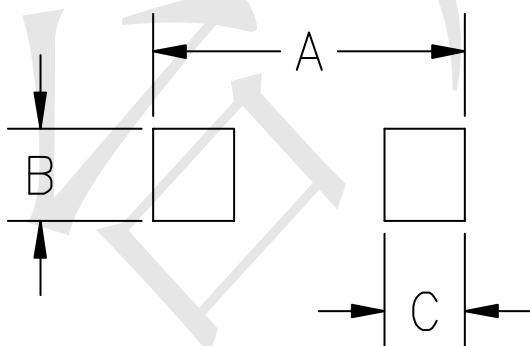

SYM	DIMENSIONS	
	MILLIMETERS	INCHES
A	3.15	0.120
B	0.80	0.031
C	0.80	0.031

X-ON Electronics

Largest Supplier of Electrical and Electronic Components

Click to view similar products for [ESD Suppressors / TVS Diodes](#) category:

Click to view products by [TECH PUBLIC](#) manufacturer:

Other Similar products are found below :

[60KS200C](#) [D18V0L1B2LP-7B](#) [D5V0F4U5P5-7](#) [NTE4902](#) [P4KE27CA](#) [P6KE11CA](#) [P6KE8.2A](#) [SA60CA](#) [SA64CA](#) [SMBJ12CATR](#)
[SMBJ33CATR](#) [SMBJ6.5A](#) [SMBJ8.0A](#) [ESD101-B1-02ELS E6327](#) [ESD112-B1-02EL E6327](#) [ESD7451N2T5G](#) [19180-510](#) [CPDT-5V0USP-](#)
[HF](#) [3.0SMCJ33CA-F](#) [3.0SMCJ36A-F](#) [HSPC16701B02TP](#) [JANTX1N6126A](#) [D3V3Q1B2DLP3-7](#) [D55V0M1B2WS-7](#) [SCM1293A-04SO](#)
[ESD200-B1-CSP0201 E6327](#) [SM12-7](#) [CEN955 W/DATA](#) [VESD12A1A-HD1-GS08](#) [CPDQC5V0-HF](#) [D1213A-01LP4-7B](#) [ESD101-B1-02EL](#)
[E6327](#) [AOZ8808DI-03](#) [5KP15A](#) [5KP48A](#) [5KP90A](#) [ESD3V3D7-TP](#) [15KPA36A-LF](#) [P4KE56CA](#) [P4KE68A](#) [P4KE91CATR](#) [P6KE120A](#)
[P6KE13CA](#) [P6KE43CA](#) [P6KE6.8CA](#) [P6KE8.2](#) [P6SMBJ20CA](#) [JANTX1N6072A](#) [SR2835ESKG](#) [SA90CA](#)