

## Features

- Protects four I/O lines
- Low capacitance (7pF) Max
- Low operating voltage: 3.3V
- Low clamping voltage
- Protects two lines in common and differential mode
- Complies with following standards:
  - IEC 61000-4-2 (ESD) immunity test
    - Air discharge:  $\pm 30\text{kV}$
    - Contact discharge:  $\pm 30\text{kV}$
  - IEC61000-4-5 (Lightning) 25A (8/20  $\mu\text{s}$ )
- RoHS Compliant

## Mechanical Characteristics

- Package: SOP-8
- Lead Finish: Matte Tin
- Case Material: "Green" Molding Compound.
- Moisture Sensitivity: Level 3 per J-STD-020
- Terminal Connections: See Diagram Below
- Shipping Qty : 2500pcs/7Inch Tape & Reel

## Applications

- T1/E1 Line Cards
- T3/E3 and DS3 Interfaces
- STS-1 Interfaces
- 10/100/1000 BaseT Ethernet
- Set Top Box
- ISDN Interfaces
- Low Voltage Interfaces

## Dimensions and Pin Configuration

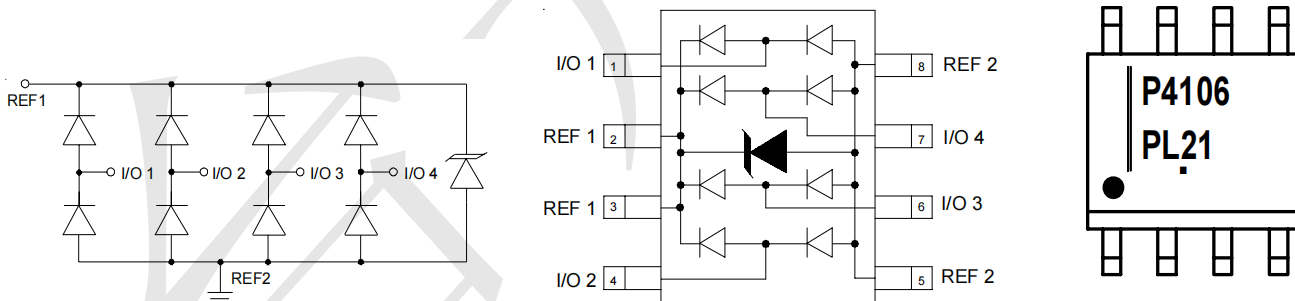

**Absolute Maximum Ratings** (Tamb=25°C unless otherwise specified)

Parameter	Symbol	Value	Unit
Peak Pulse Power(8/20μs)	Ppk	500	W
Peak Forward Voltage (IF=1A, tp=8/20μs)	VFP	1.5	V
Lead Soldering Temperature	TL	260(10 sec.)	°C
Operating Temperature Range	TJ	-55 to +125	°C
Storage Temperature Range	Tstg	-55 to +150	°C

**Electrical Characteristics** (TA=25°C unless otherwise specified)

Parameter	Symbol	Min	Typ	Max	Unit	Test Condition
Reverse Working Voltage	VRWM			3.3	V	
Reverse Breakdown Voltage	VBR	4.5			V	IT = 1mA
Reverse Leakage Current	IR			2	μA	VRWM = 3.3V, T=25°C
Clamping Voltage	VC			8	V	I <sub>PP</sub> = 1A (8 x 20μs pulse) Line to Ground
Clamping Voltage	VC			10	V	I <sub>PP</sub> = 10A (8 x 20μs pulse) Line to Ground
Clamping Voltage	VC			15	V	I <sub>PP</sub> = 25A (8 x 20μs pulse) Line to Ground
Junction Capacitance	CJ		5	7	pF	VR = 0V, f = 1MHz Between I/O pins and Ground
			3		pF	VR = 0V, f = 1MHz Between I/O pins



**Typical Performance Characteristics ( $T_A=25^\circ\text{C}$  unless otherwise Specified)**

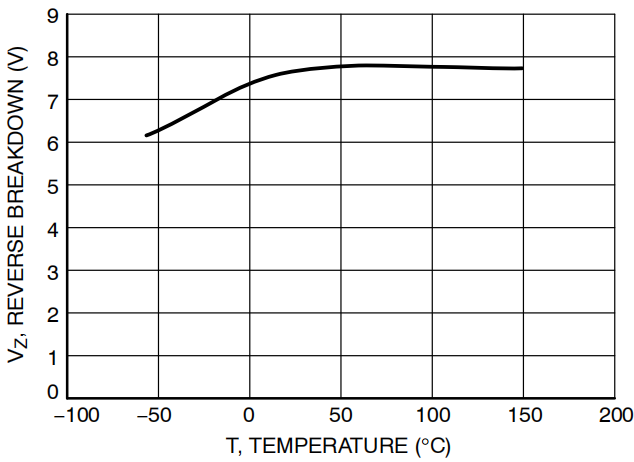

**Figure 1. Reverse Breakdown versus Temperature**

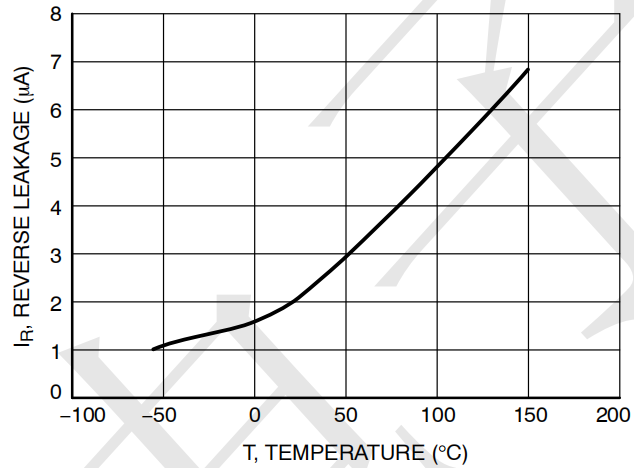

**Figure 2. Reverse Leakage versus Temperature**

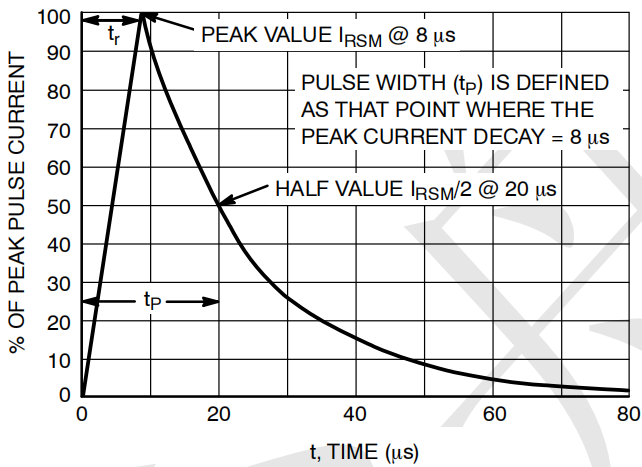

**Figure 3. 8 x 20 µs Pulse Waveform**

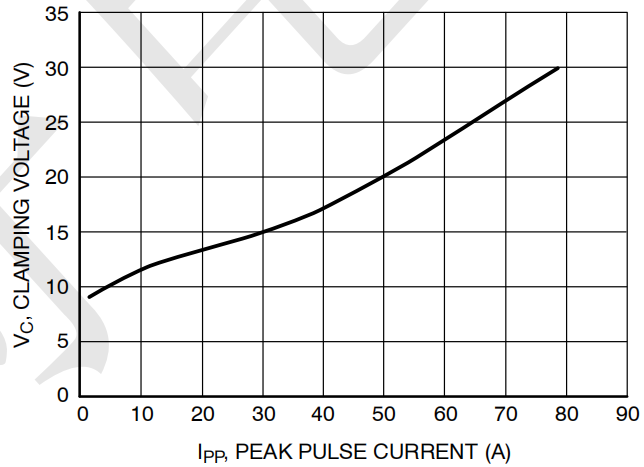

**Figure 4. Clamping Voltage versus Peak Pulse Current**



**SOP-8 Package Outline Drawing**

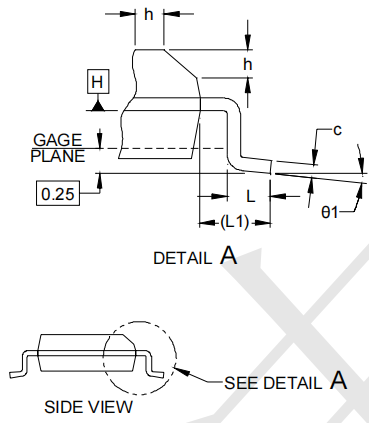
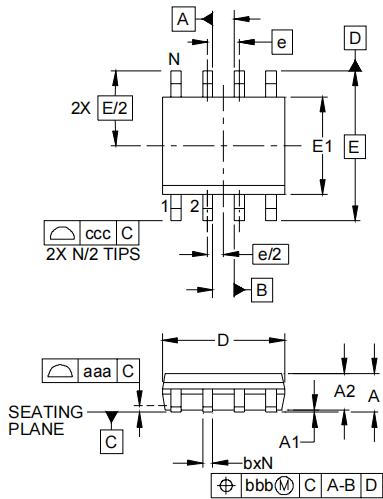

DIM	INCHES			MILLIMETERS		
	MIN	NOM	MAX	MIN	NOM	MAX
A	.053	-	.069	1.35	-	1.75
A1	.004	-	.010	0.10	-	0.25
A2	.049	-	.065	1.25	-	1.65
b	.012	-	.020	0.31	-	0.51
c	.007	-	.010	0.17	-	0.25
D	.189	.193	.197	4.80	4.90	5.00
E1	.150	.154	.157	3.80	3.90	4.00
E	.236 BSC			6.00 BSC		
e	.050 BSC			1.27 BSC		
h	.010	-	.020	0.25	-	0.50
L	.016	.028	.041	0.40	0.72	1.04
L1	( .041 )			( 1.04 )		
N	8			8		
01	0°		8°	0°		8°
aaa	.004			0.10		
bbb	.010			0.25		
ccc	.008			0.20		

**Suggested Land Pattern**

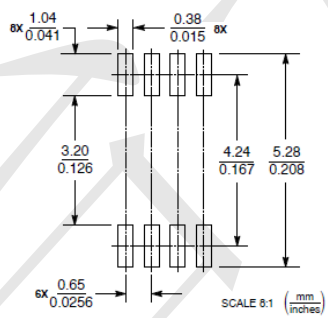

## X-ON Electronics

Largest Supplier of Electrical and Electronic Components

*Click to view similar products for [ESD Suppressors / TVS Diodes](#) category:*

*Click to view products by [TECH PUBLIC](#) manufacturer:*

Other Similar products are found below :

[60KS200C](#) [D18V0L1B2LP-7B](#) [D5V0F4U5P5-7](#) [NTE4902](#) [P4KE27CA](#) [P6KE11CA](#) [P6KE8.2A](#) [SA60CA](#) [SA64CA](#) [SMBJ12CATR](#)  
[SMBJ33CATR](#) [SMBJ6.5A](#) [SMBJ8.0A](#) [ESD101-B1-02ELS E6327](#) [ESD112-B1-02EL E6327](#) [ESD7451N2T5G](#) [19180-510](#) [CPDT-5V0USP-](#)  
[HF](#) [3.0SMCJ33CA-F](#) [3.0SMCJ36A-F](#) [HSPC16701B02TP](#) [JANTX1N6126A](#) [D3V3Q1B2DLP3-7](#) [D55V0M1B2WS-7](#) [SCM1293A-04SO](#)  
[ESD200-B1-CSP0201 E6327](#) [SM12-7](#) [CEN955 W/DATA](#) [VESD12A1A-HD1-GS08](#) [CPDQC5V0-HF](#) [D1213A-01LP4-7B](#) [ESD101-B1-02EL](#)  
[E6327](#) [AOZ8808DI-03](#) [5KP15A](#) [5KP48A](#) [5KP90A](#) [ESD3V3D7-TP](#) [15KPA36A-LF](#) [P4KE56CA](#) [P4KE68A](#) [P4KE91CATR](#) [P6KE120A](#)  
[P6KE13CA](#) [P6KE43CA](#) [P6KE6.8CA](#) [P6KE8.2](#) [P6SMBJ20CA](#) [JANTX1N6072A](#) [SR2835ESKG](#) [SA90CA](#)