

Features

- 2 μ A Ground Current at no Load
- $\pm 2\%$ Output Accuracy
- 200mA Output Current
- Wide Operating Input Voltage Range: 3V to 36V
- Support Fixed Output Voltage 1.8V, 2.5V, 3.0V, 3.3V, 3.6V, 4.0V, 4.2V, 5.0V
- SOT-23-5 Package Available

Applications

- Portable, Battery Powered Equipment
- Low Power Microcontrollers
- Laptop, Palmtops and PDAs
- Wireless Communication Equipment

Ordering Information

TP375C33S5

S5: SOT23-5 Package

Output voltage: 12=1.2V
15=1.5V
18=1.8V
30=3.0V
33=3.3V
50=5.0V

Marking Information



P: Logo
XXX: Marking ID

30=3.0V
33=3.3V
50=5.0V
A2=12V

PIN CONFIGURATION

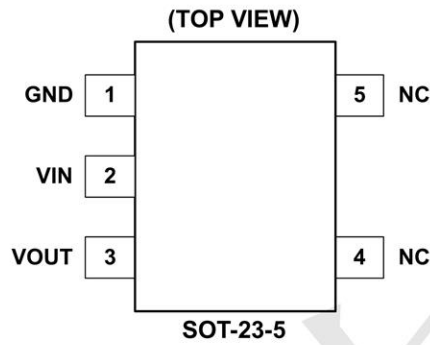

Pin Name	Pin Function
VIN	Power Input Voltage
GND	Ground
OUT	Output Voltage
NC	NO Connected
NC	NO Connected

Typical Application Circuit

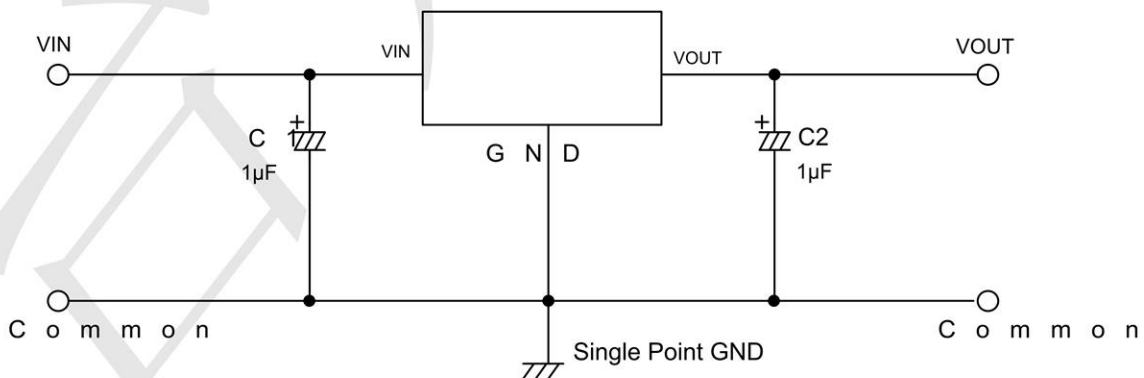

BLOCK DIAGRAM

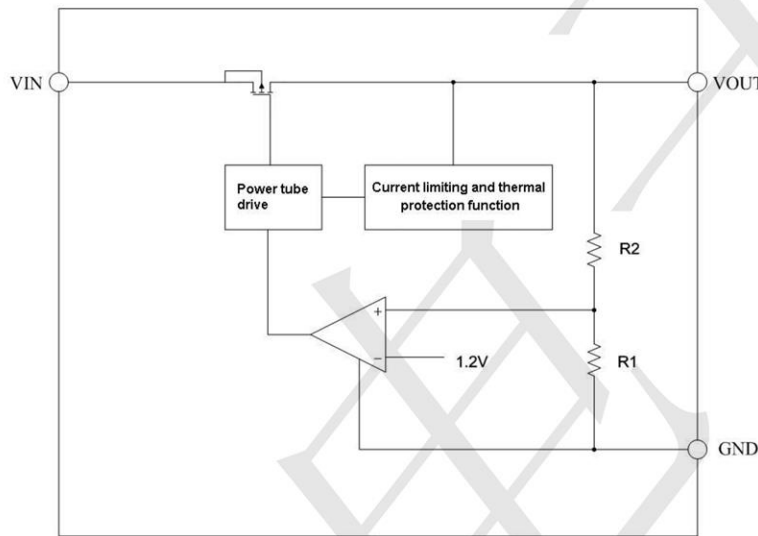

Absolute Maximum Ratings

Parameter		Value	Unit
Supply Voltage		-0.3 ~ +40	V
	SOT-23-5	400	mW
Operating Junction Temperature	SOT-23-5	380	°C/W
Storage Temperature Range		-40 ~ +125	°C
Lead Temperature (Soldering, 10 sec)		-65 ~ +150	°C
ESD(HBM mode, ESDA/JEDECJS-001-2017)		300	°C
		+2000	V

Electrical Characteristics

($V_{IN}=V_{OUT}+2$, $C_{IN}=1\mu F$, $C_{OUT}=1\mu F$, $T_A=25^\circ C$, unless otherwise noted.)

Parameter	Symbol	Test Conditions	Min.	Typ.	Max.	Unit	
Input Voltage	V_{IN}		3	--	36	V	
Output Voltage Accuracy	ΔV_{OUT}	$I_{OUT}=1mA$	-2	--	+2	%	
Maximum Output Current	$I_{OUT(Max)}$		150	--	--	mA	
Quiescent Current	I_Q	$I_{OUT}=0mA$	--	2		μA	
Dropout Voltage	V_{DROP}	$V_{OUT}=1.8V$	$I_{OUT}=150mA$	--	1250	1450	mV
			$I_{OUT}=100mA$	--	880	1050	mV
		$V_{OUT}=2.5V$	$I_{OUT}=150mA$	--	1150	1350	mV
			$I_{OUT}=100mA$	--	800	1000	mV
		$V_{OUT}=3.0V$	$I_{OUT}=150mA$	--	820	960	mV
			$I_{OUT}=100mA$	--	530	700	mV
		$V_{OUT}=3.3V$	$I_{OUT}=150mA$	--	800	950	mV
			$I_{OUT}=100mA$	--	520	680	mV
		$V_{OUT}=3.6V$	$I_{OUT}=150mA$	--	750	930	mV
			$I_{OUT}=100mA$	--	500	660	mV
		$V_{OUT}=5.0V$	$I_{OUT}=150mA$	--	670	900	mV
			$I_{OUT}=100mA$	--	420	600	mV
Line Regulation	ΔV_{LINE}	$V_{IN}=V_{OUT}+2V$ to 30V $I_{OUT}=10mA$	--	--	0.2	%/V	
Load Regulation	ΔV_{LOAD}	$V_{IN}=V_{OUT}+2V$, $1mA < I_{OUT} < 150mA$	--	25	60	mV	
Short Current Protection	I_{Short}	OUT Short to GND	--	80	--	mA	
Output Noise	e_N	10Hz to 100KHz $I_{OUT}=30mA$	--	120	--	μV_{RMS}	
Power Supply Rejection Ratio	PSRR	$V_{IN}=12V$, $I_{OUT}=1mA$	--	68	--	dB	

Typical Operating Characteristics

Line-Transient Response

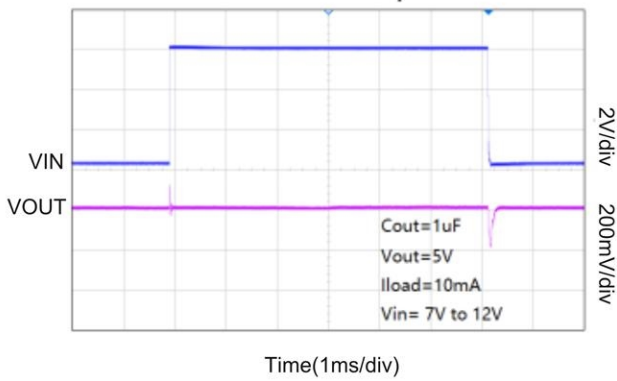

Line-Transient Response

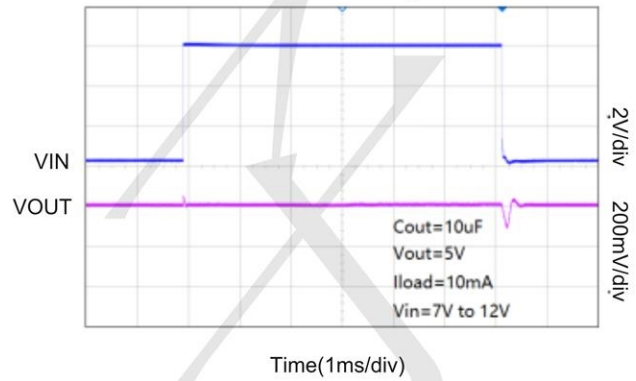

Load-Transient Response

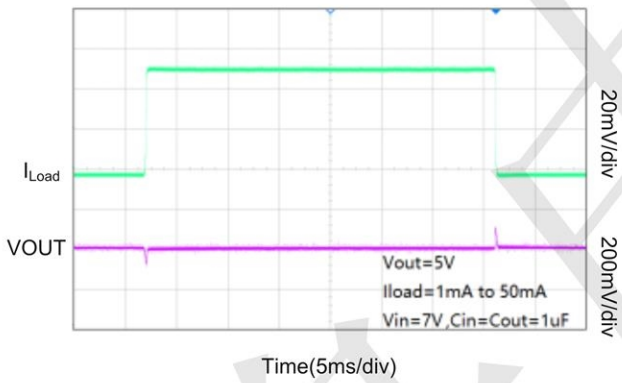

Load-Transient Response

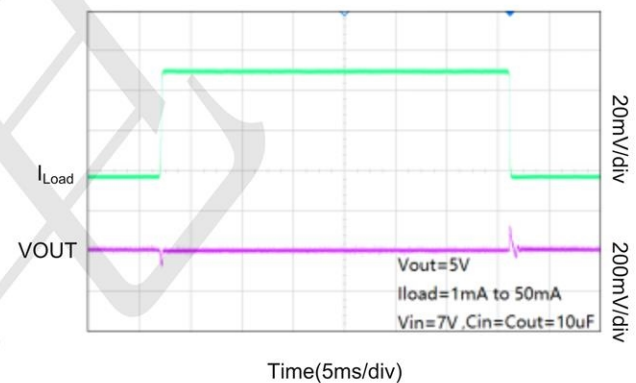

Start up Response

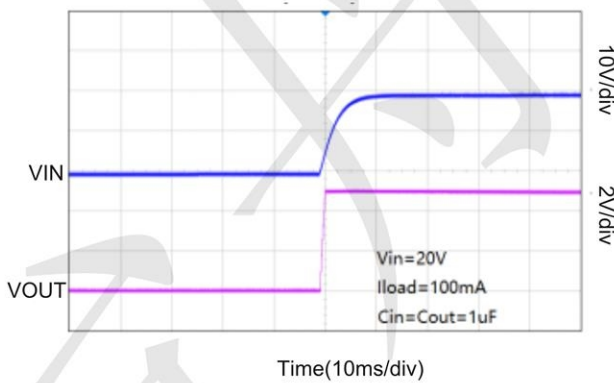

Start up Response

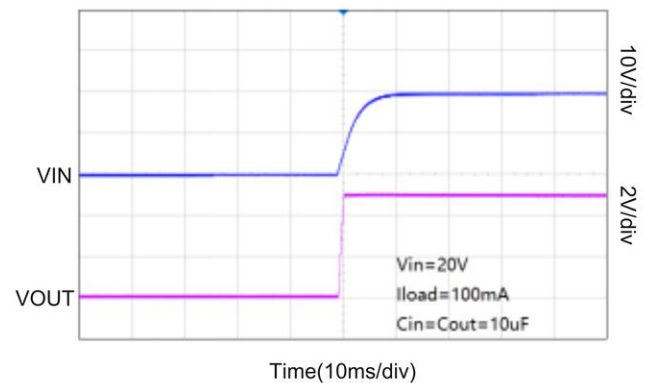



Package information
SOT23-5

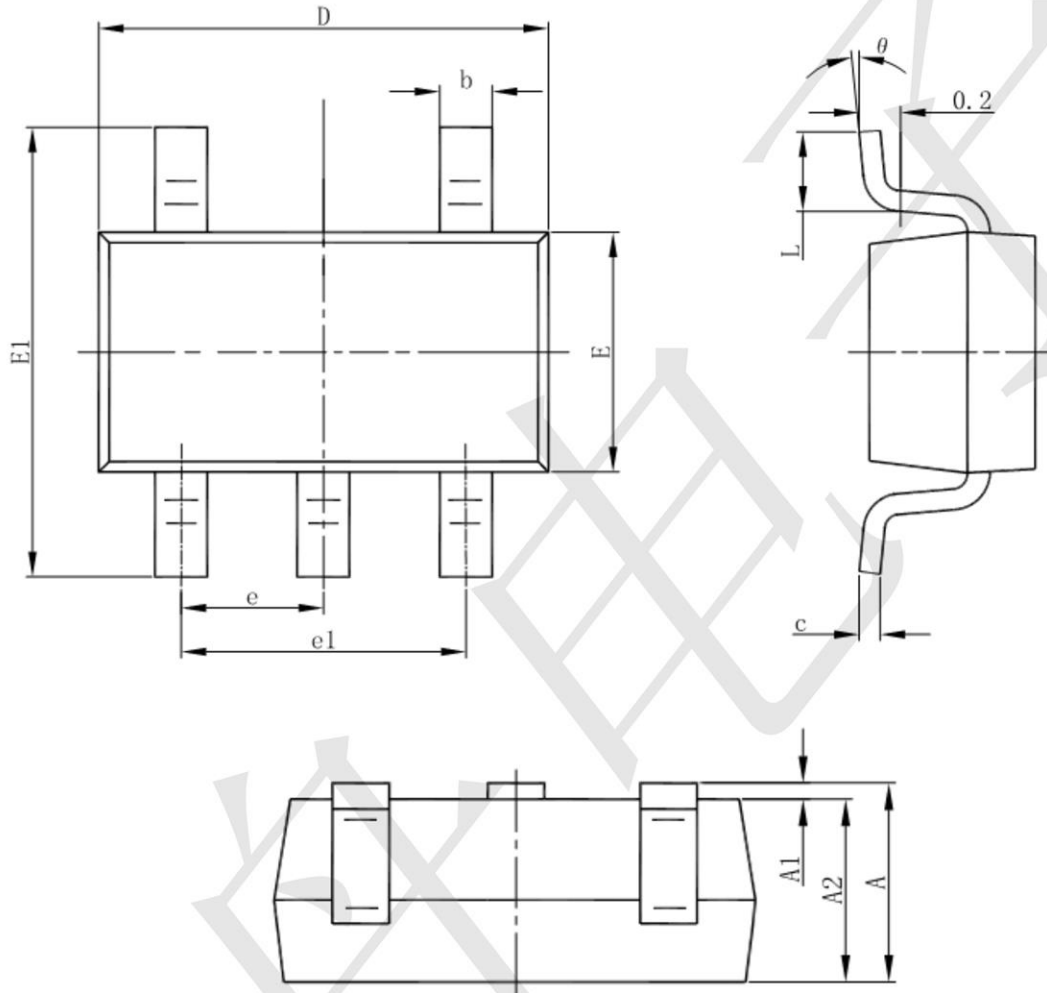

Symbol	Dimensions In Millimeters		Dimensions In Inches	
	Min	Max	Min	Max
A	1.050	1.250	0.041	0.049
A1	0.000	0.100	0.000	0.004
A2	1.050	1.150	0.041	0.045
b	0.300	0.500	0.012	0.020
c	0.100	0.200	0.004	0.008
D	2.820	3.020	0.111	0.119
E	1.500	1.700	0.059	0.067
E1	2.650	2.950	0.104	0.116
e	0.950(BSC)		0.037(BSC)	
e1	1.800	2.000	0.071	0.079
L	0.300	0.600	0.012	0.024
θ	0°	8°	0°	8°

X-ON Electronics

Largest Supplier of Electrical and Electronic Components

Click to view similar products for [Linear Voltage Regulators](#) category:

Click to view products by [TECH PUBLIC](#) manufacturer:

Other Similar products are found below :

[LV56831P-E](#) [LV5684PVD-XH](#) [MCDTSA6-2R](#) [L7815ACV-DG](#) [PQ3DZ53U](#) [LV56801P-E](#) [TLE42794G](#) [L78L05CZ/1SX](#) [L78LR05DL-MA-E](#) [636416C](#) [714954EB](#) [BA033LBSG2-TR](#) [LV5680P-E](#) [L78M15CV-DG](#) [L79M05T-E](#) [TLS202A1MBVHTSA1](#) [L78LR05D-MA-E](#) [NCV317MBTG](#) [NTE7227](#) [LV5680NPVC-XH](#) [LT1054CN8](#) [MP2018GZD-5-Z](#) [MP2018GZD-33-Z](#) [MIC5281-3.3YMM](#) [MC78L06BP-AP](#) [TA48LS05F\(TE85L,F\)](#) [TA78L12F\(TE12L,F\)](#) [TC47BR5003ECT](#) [TCR2LN12,LF\(S](#) [TCR2LN28,LF\(S](#) [TCR2LN30,LF\(S](#) [TCR3DF295,LM\(CT](#) [TCR3DF40,LM\(CT](#) [BA178M20CP-E2](#) [L78M12ABDT](#) [LM7812SX/NOPB](#) [LR645N3-G-P003](#) [LR645N3-G-P013](#) [ZXTR2005P5-13](#) [SCD7812BTG](#) [TCR3DF335,LM\(CT](#) [ZXTR2012K-13](#) [TLE42994E V33](#) [ZXTR2008K-13](#) [ZXTR2005K-13](#) [L88R05DL-E](#) [ADP3300ARTZ-2.7RL7](#) [LM120K-15/883](#) [IFX54441LDVXUMA1](#) [LM317D2T-TR](#)