

General Description

The TP6327GS6-A is a fully integrated, high-efficiency peak 3.0A synchronous rectified step-down converter. The TP6327GS6-A operates at high efficiency over a wide output current load range.

This device offers two operation modes, PWM control and PFM Mode switching control, which allows a high efficiency over the wider range of the load.

The TP6327GS6-A requires a minimum number of readily available standard external components and is available in a SOT23-6 package.

Applications

- Distributed Power Systems
- Digital Set Top Boxes
- Flat Panel Television and Monitors
- Notebook computer
- Wireless and DSL Modems

Features

- High Efficiency: Up to 95%@5V
- 600kHz Frequency Operation
- 3.0A Peak Output Current
- 2.5A Continuous Current
- No Schottky Diode Required
- 3.5V to 18V Input Voltage Range
- 0.765V Reference
- Slope Compensated Current Mode Control for Excellent Line and Load Transient Response
- Integrated internal compensation
- Stable with Low ESR Ceramic Output Capacitors
- Over Current Protection with Hiccup-Mode
- Input overvoltage protection (OVP)
- Thermal Shutdown
- Inrush Current Limit and Soft Start
- Available in SOT23-6 Package

PIN CONFIGURATION

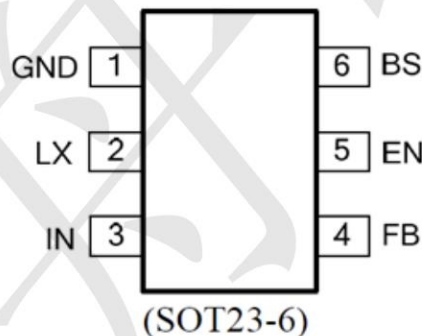

Pin No.	Pin Name	Pin Function
1	GND	Ground.
2	LX	Switching Pin.
3	IN	Power supply Pin.
4	FB	Adjustable version feedback input. Connect FB to the center point of the external resistor divider. Not floating.
5	EN	Drive this pin to a logic-high to enable the IC. Drive to a logic-low to disable the IC and enter micro-power shutdown mode.
6	BS	Bootstrap. A capacitor connected between LX and BS pins is required to form a floating supply across the high-side switch driver.

TYPICAL APPLICATION

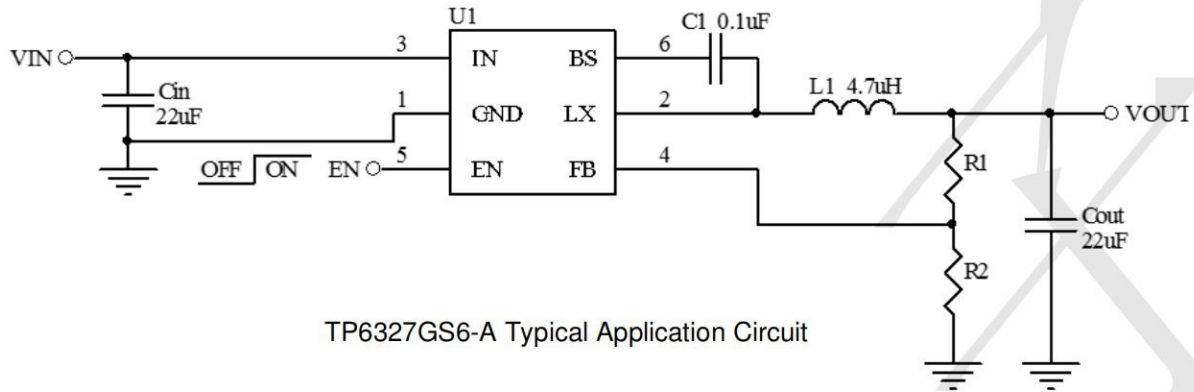

TP6327GS6-A Typical Application Circuit

Absolute Maximum Rating ($T_A=25^{\circ}\text{C}$ unless otherwise noted)

IN Pin and EN Pin Voltage	- 0.3V to 20V
LX Pin Voltage	- 0.3V to 20V
LX Pin Voltage(10ns transient)	- 4V to 25V
BS Pin Voltage	($V_{LX} - 0.3\text{V}$) to ($V_{LX} + 6\text{V}$)
FB Pin Voltage	- 0.3V to 6V
Junction Temperature _(Note2)	160°C
Lead Temperature	260°C
Storage Temperature Range	- 65°C ~ 150°C
Operating Junction Temperature Range	- 40°C ~ 125°C
Power Dissipation.....	600mW

Electrical Characteristics

($V_{IN}=12V$, $V_{EN}=5V$, $T_A=25^{\circ}C$, unless otherwise specified.) (Note1)

PARAMETER	SYMBOL	CONDITIONS	MIN	TYP	MAX	UNITS
Input Voltage Range	V_{IN}		3.5		18	V
OVP Threshold	V_{OVP}			19		V
UVLO Threshold	V_{UVLO}		3.0			V
Supply Current in Operation		$V_{EN}=2.0V$, $V_{FB}=1.1V$		0.4	0.6	mA
Supply Current in Shutdown		$V_{EN}=0$ or $EN = GND$		1		μA
Regulated Feedback Voltage	V_{FB}	$T_A = 25^{\circ}C$, $3.5V \leq V_{IN} \leq 18V$	0.75	0.765	0.78	V
High-Side Switch On-Resistance	$R_{DS(ON)1}$			120		m Ω
Low-Side Switch On-Resistance	$R_{DS(ON)2}$			70		m Ω
High-Side Switch Leakage Current		$V_{EN}=0V$, $V_{LX}=0V$		0	10	μA
Upper Switch Current Limit		Minimum Duty Cycle	3.5	3.9		A
Oscillation Frequency	f_{OSC}	$V_{FB}=0.765V$		600		kHz
Maximum Duty Cycle	D_{MAX}	$V_{FB}=0.765V$		95		%
EN High Level Input Threshold			1.15	1.30	1.45	V
EN Low Level Input Threshold				1.28		V
Soft Start time	T_{SS}			800		μs
Minimum On-Time	T_{ON}			60		ns
Thermal Shutdown	T_{SD}			160		$^{\circ}C$

Typical Characteristics

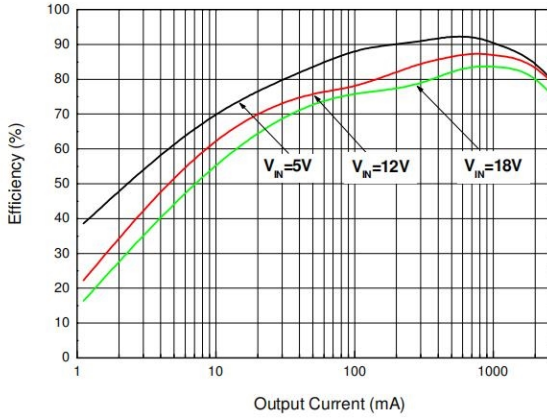

Fig. 1 Efficiency vs. Output Current ($V_{OUT}=1.8V$)

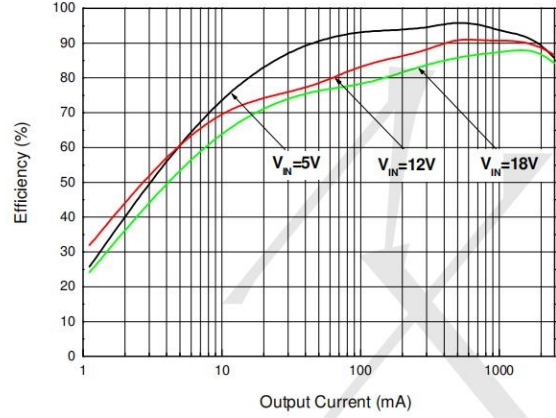

Fig. 2 Efficiency vs. Output Current ($V_{OUT}=3.3V$)

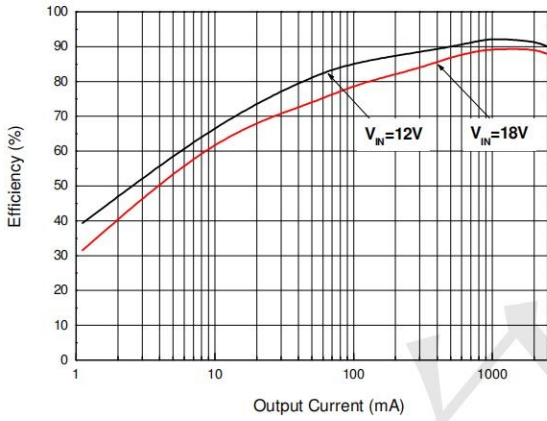

Fig. 3 Efficiency vs. Output Current ($V_{OUT}=5V$)

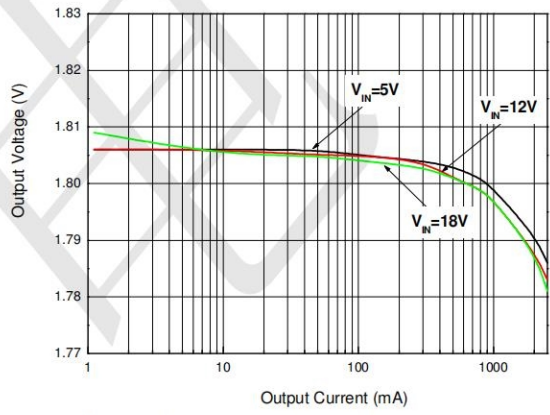

Fig. 4 Output Voltage vs. Output Current ($V_{OUT}=1.8V$)

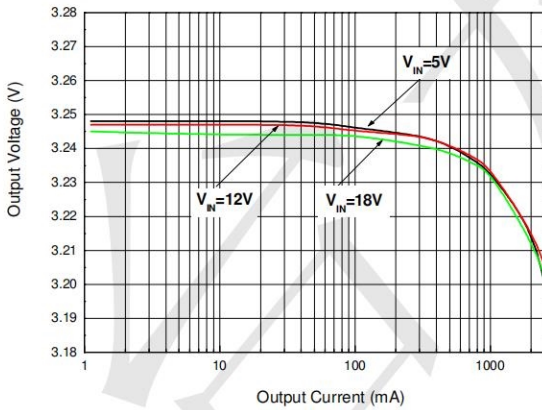

Fig. 5 Output Voltage vs. Output Current ($V_{OUT}=3.3V$)

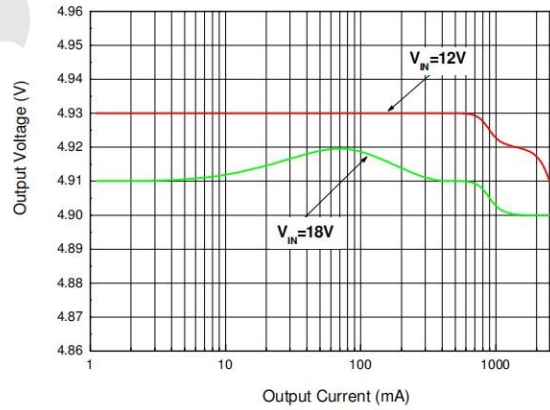
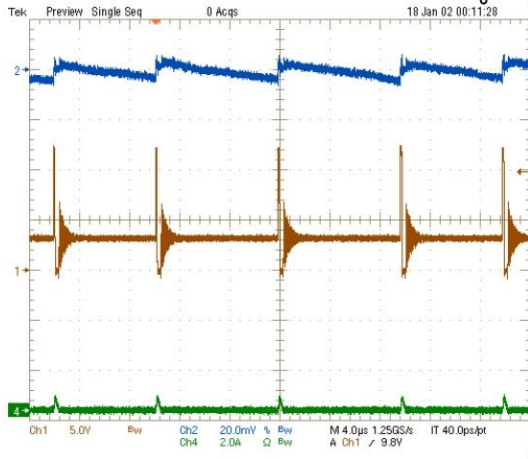
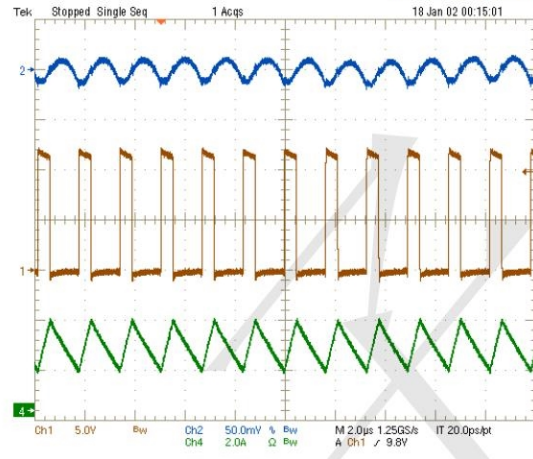

Fig. 6 Output Voltage vs. Output Current ($V_{OUT}=5V$)



LX, CH2: $V_{OUT(ac)}$, CH4: I_L
 $I_N=12V$, $V_{OUT}=3.3V$, $I_{OUT}=10mA$



(CH1: V_{LX} , CH2: $V_{OUT(ac)}$, CH4: I_L)
Fig. 8 Output Ripple ($V_{IN}=12V$, $V_{OUT}=3.3V$, $I_{OUT}=2.5A$)

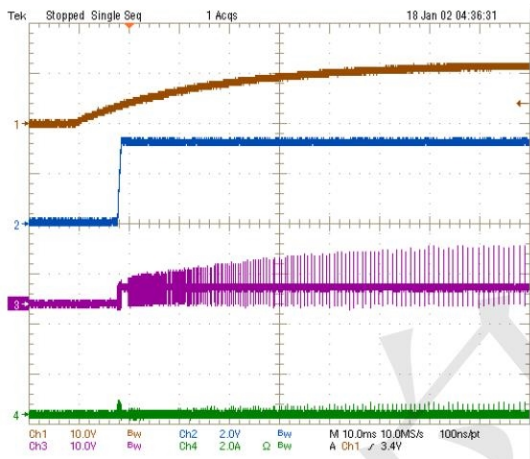

I_N , CH2: V_{OUT} , CH3: V_{LX} , CH4: I_L
 I_N Power On ($V_{IN}=12V$, $V_{OUT}=3.3V$, $I_{OUT}=0A$)



(CH1: V_{IN} , CH2: V_{OUT} , CH3: V_{LX} , CH4: I_L)
Fig. 10 V_{IN} Power On ($V_{IN}=12V$, $V_{OUT}=3.3V$, $I_{OUT}=2.5A$)

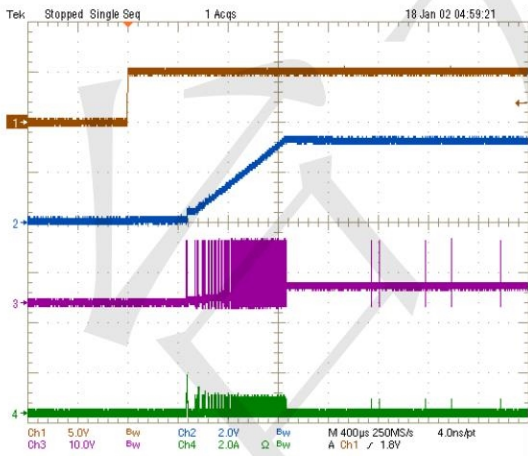

E_N , CH2: V_{OUT} , CH3: V_{LX} , CH4: I_L
 $I_N=12V$, $V_{OUT}=3.3V$, $I_{OUT}=0A$

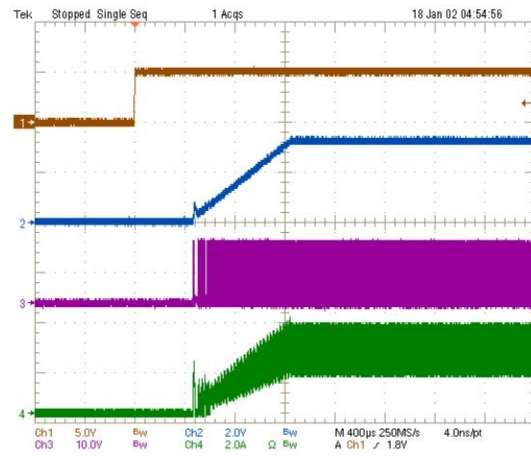

(CH1: V_{EN} , CH2: V_{OUT} , CH3: V_{LX} , CH4: I_L)
Fig. 12 Enable On ($V_{IN}=12V$, $V_{OUT}=3.3V$, $I_{OUT}=2.5A$)

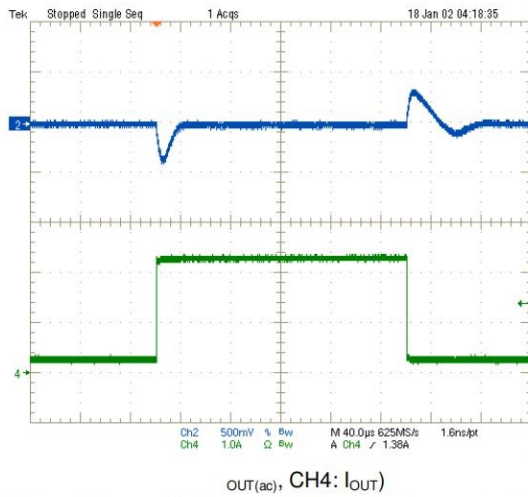

Fig. 13 Load Transient ($V_{IN}=12V$, $V_{OUT}=3.3V$, $I_O=0.25-2.25A$)

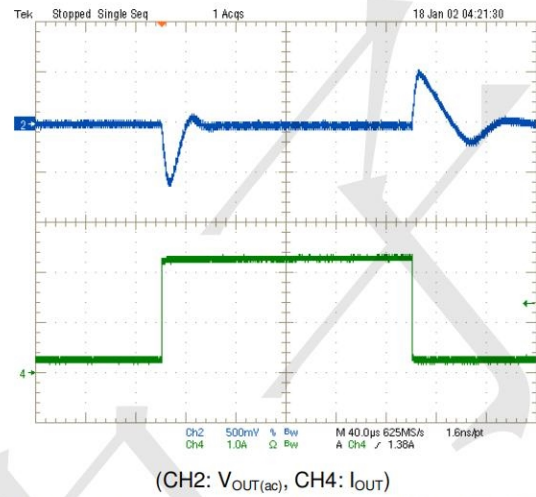
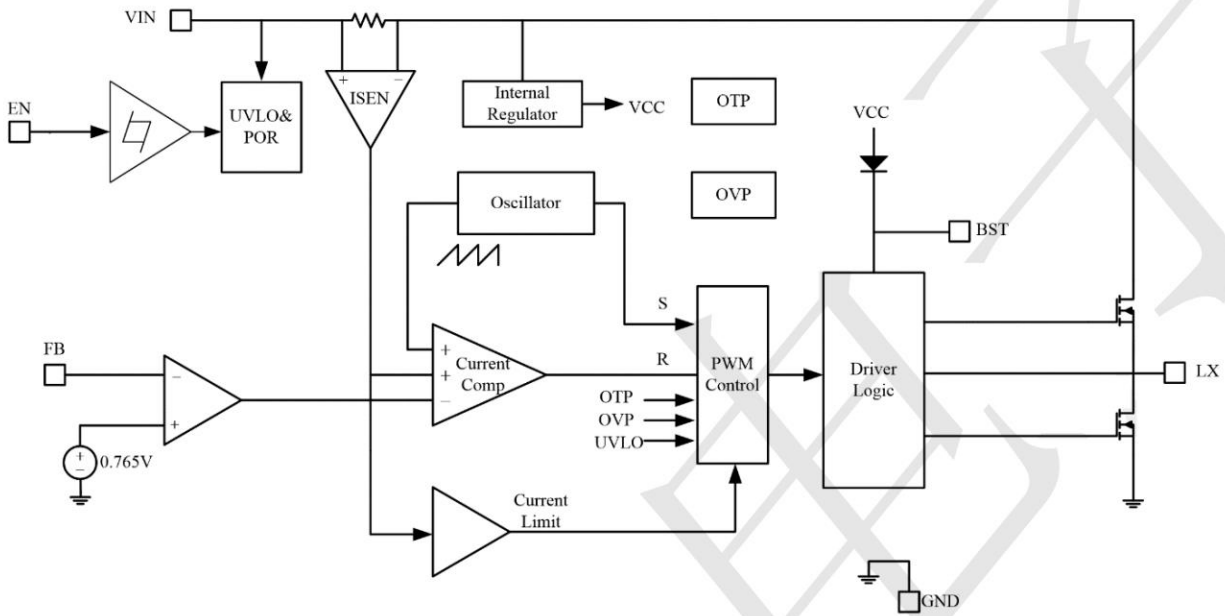

Fig. 14 Load Transient ($V_{IN}=12V$, $V_{OUT}=5V$, $I_O=0.25-2.25A$)

BLOCK DIAGRAM



Internal Regulator

The TP6327GS6-A is a current mode step down DC/DC converter that provides excellent transient response with no extra external compensation components. This device contains an internal, low resistance, high voltage power MOSFET, and operates at a high 600kHz operating frequency to ensure a compact, high efficiency design with excellent AC and DC performance.

Error Amplifier

The error amplifier compares the FB pin voltage with the internal FB reference (V_{FB}) and outputs a current proportional to the difference between the two. This output current is then used to charge or discharge the internal compensation network to form the COMP voltage, which is used to control the power MOSFET current. The optimized internal compensation network minimizes the external component counts and simplifies the control loop design.

Internal Soft-Start

The soft-start is implemented to prevent the converter output voltage from overshooting during startup. When the chip starts, the internal circuitry generates a soft-start voltage (SS) ramping up from 0V to 0.765V. When it is lower than the internal reference (REF), SS overrides REF so the error amplifier uses SS as the reference. When SS is higher than REF, REF regains control. The SS time is internally fixed to 800 μ s.

Over-Current-Protection and Hiccup

The TP6327GS6-A has cycle-by-cycle over current limit when the inductor current peak value exceeds the set current limit threshold. Meanwhile, output voltage starts to drop until FB is below the Under-Voltage (UV) threshold, typically 30% below the reference. Once a UV is triggered, the TP6327GS6-A enters hiccup

mode to periodically restart the part. This protection mode is especially useful when the output is dead-short to ground. The average short circuit current is greatly reduced to alleviate the thermal issue and to protect the regulator. The TP6327GS6-A exits the hiccup mode once the over current condition is removed.

Startup and Shutdown

If both VIN and EN are higher than their appropriate thresholds, the chip starts. The reference block starts first, generating stable reference voltage and currents, and then the internal regulator is enabled. The regulator provides stable supply for the remaining circuitries. Three events can shut down the chip: EN low, VIN low and thermal shutdown. In the shutdown procedure, the signaling path is first blocked to avoid any fault triggering. The COMP voltage and the internal supply rail are then pulled down. The floating driver is not subject to this shutdown command.

Setting the Output Voltage

The external resistor divider is used to set the output voltage (see figure 15). The feedback resistor R_1 also sets the feedback loop bandwidth with the internal compensation capacitor. Choose R_1 to be around 10k Ω for optimal transient response. R_2 is then given by:

$$R_2 = \frac{R_1}{\frac{V_{out}}{V_{FB}} - 1}$$

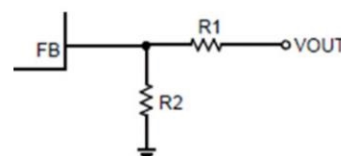

Fig. 15 External Resistor Divider

Inductor Selection

A 2.2 μ H to 6.8 μ H inductor with a DC current rating of at least 25% percent higher than the maximum load

current is recommended for most applications. For highest efficiency, the inductor DC resistance should be less than 15mΩ. For most designs, the inductance value can be derived from the following equation.

$$L = \frac{V_{out} \times (V_{in} - V_{out})}{V_{in} \times \Delta I_L \times f_{OSC}}$$

Where ΔI_L is the inductor ripple current. Choose inductor ripple current to be approximately 30% if the maximum load current 3A. The maximum inductor peak current is:

$$I_{L(MAX)} = I_{LOAD} + \frac{\Delta I_L}{2}$$

Under light load conditions below 100mA, larger inductance is recommended for improved efficiency.

Output Capacitor Selection

The output capacitor (C_2) is required to maintain the DC output voltage. Ceramic, tantalum, or low ESR electrolytic capacitors are recommended. Low ESR capacitors are preferred to keep the output voltage ripple low. The output voltage ripple can be estimated by:

$$\Delta V_{OUT} = \frac{V_{OUT}}{f_s \times L} \times \left[1 - \frac{V_{OUT}}{V_{IN}} \right] \times \left[R_{ESR} + \frac{1}{8 \times f_s \times C_2} \right]$$

Where L is the inductor value and R_{ESR} is the equivalent series resistance (ESR) value of the output capacitor. In the case of ceramic capacitors, the impedance at the switching frequency is dominated by the capacitance. The output voltage ripple is mainly caused by the capacitance. For simplification, the output voltage ripple can be estimated by:

$$\Delta V_{OUT} = \frac{V_{OUT}}{8 \times f_s^2 \times L \times C_2} \times \left[1 - \frac{V_{OUT}}{V_{IN}} \right]$$

In the case of tantalum or electrolytic capacitors, the

ESR dominates the impedance at the switching frequency. For simplification, the output ripple can be approximated to:

$$\Delta V_{OUT} = \frac{V_{OUT}}{f_s \times L} \times \left[1 - \frac{V_{OUT}}{V_{IN}} \right] \times R_{ESR}$$

The characteristics of the output capacitor also affect the stability of the regulation system. The TP6327GS6-A can be optimized for a wide range of capacitance and ESR values.

Layout Consideration

PCB layout is very important to achieve stable operation. It is highly recommended to duplicate EVB layout for optimum performance. If change is necessary, please follow these guidelines.

- (1) Keep the path of switching current short and minimize the loop area formed by Input capacitor, high-side MOSFET and low-side MOSFET.
- (2) Bypass ceramic capacitors are suggested to be put close to the IN Pin.
- (3) Ensure all feedback connections are short and direct. Place the feedback resistors and compensation components as close to the chip as possible.
- (4) VOUT, LX away from sensitive analog areas such as FB.
- (5) Connect IN, LX, and especially GND respectively to a large copper area to cool the chip to improve thermal performance and long-term reliability.



TECH PUBLIC

—台丹电子—

TP6327GS6-A

18V 3A 600KHz Synchronous Step-Down Converter

www.sot23.com.tw

Package information

SOT23-6

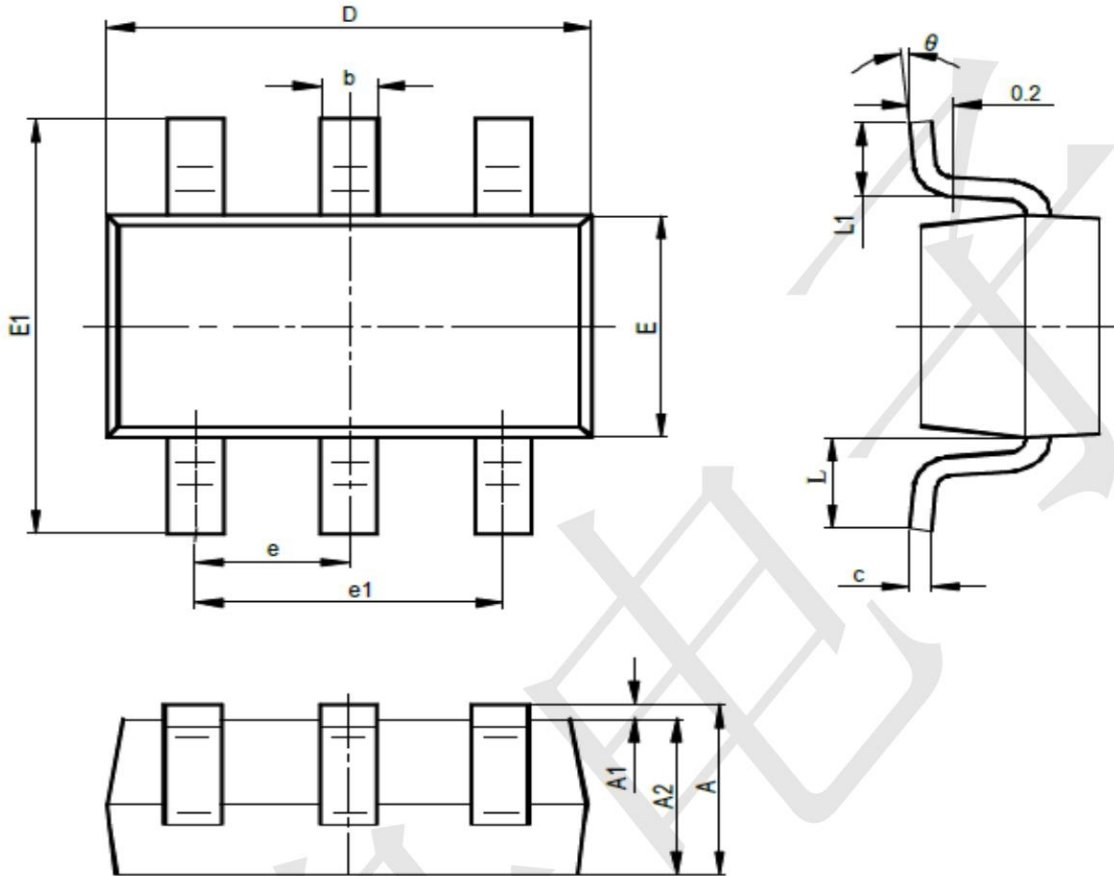

SYMBOL	MILLIMETERS		INCHES	
	MIN	MAX	MIN	MAX
A	1.050	1.250	0.041	0.049
A1	0.000	0.100	0.000	0.004
A2	1.050	1.150	0.041	0.045
b	0.300	0.400	0.012	0.016
c	0.100	0.200	0.004	0.008
D	2.820	3.020	0.111	0.119
E	1.500	1.700	0.059	0.067
E1	2.650	2.950	0.104	0.116
e	0.950TYP		0.037TYP	
e1	1.800	2.000	0.071	0.079
L	0.700REF		0.028REF	
L1	0.300	0.600	0.012	0.024
θ	0°	8°	0°	8°

X-ON Electronics

Largest Supplier of Electrical and Electronic Components

Click to view similar products for [Switching Controllers](#) category:

Click to view products by [TECH PUBLIC](#) manufacturer:

Other Similar products are found below :

[NCP1218AD65R2G](#) [NCP1234AD100R2G](#) [NCP1244BD065R2G](#) [NCP1336ADR2G](#) [NCP6153MNTWG](#) [NCP81101BMNTXG](#)
[NCP81205MNTXG](#) [SJE6600](#) [AZ7500BMTR-E1](#) [IR35215MTRPBF](#) [SG3845DM](#) [NCP4204MNTXG](#) [NCP6132AMNR2G](#)
[NCP81102MNTXG](#) [NCP81203MNTXG](#) [NCP81206MNTXG](#) [NX2155HCUPTR](#) [UBA2051C](#) [IR35201MTRPBF](#) [FSL4110LRLX](#)
[NCP1015ST65T3G](#) [NCP1240AD065R2G](#) [NCP1240FD065R2G](#) [NCP1336BDR2G](#) [NCP1361BABAYSNT1G](#) [NCP1230P100G](#)
[NX2124CSTR](#) [SG2845M](#) [NCP1366BABAYDR2G](#) [NCP81101MNTXG](#) [TEA19362T/1J](#) [NCP81174NMNTXG](#) [NCP4308DMTTWG](#)
[NCP4308DMNTWG](#) [NCP4308AMTTWG](#) [NCP1366AABAYDR2G](#) [NCP1256ASN65T1G](#) [NCP1251FSN65T1G](#) [NCP1246BLD065R2G](#)
[MB39A136PFT-G-BND-ERE1](#) [NCP1256BSN100T1G](#) [LV5768V-A-TLM-E](#) [NCP1365BABCYDR2G](#) [NCP1365AABCYDR2G](#)
[IR35204MTRPBF](#) [MCP1633T-E/MG](#) [MCP1633-E/MG](#) [NCV1397ADR2G](#) [NCP81599MNTXG](#) [NCP1246ALD065R2G](#)