

## General Description

TP6841S6 is a current mode monolithic buck switching regulator. Operating with an input range of 4.5V~40V, the TP6841S6 delivers 800mA of continuous output current with two integrated N-Channel MOSFETs. The internal synchronous power switches provide high efficiency without the use of an external Schottky diode. At light loads, the regulator operates in low frequency to maintain high efficiency and low output ripple. Current mode control provides tight load transient response and cycle-by-cycle current limit.

The TP6841S6 guarantees robustness with short-circuit protection, thermal protection, current run-away protection, and input under voltage lockout.

The TP6841S6 is available in 6-pin SOT23-6L package, which provides a compact solution with minimal external components.

## Applications

- 4.5V to 40V Input Voltage Range
- 800mA output current
- High Efficiency: Up to 95%
- No Schottky Diode Required
- 0.8V Reference
- Slope Compensated Current Mode Control for Excellent Line and Load Transient Response
- Integrated internal compensation
- Stable with Low ESR Ceramic Output Capacitors
- Input under voltage lockout
- Short circuit protection
- Thermal Shutdown
- Inrush Current Limit and Soft Start
- -40°C to +125°C Temperature Range
- SOT23-6L Package

## Features

- Distributed Power Systems
- Automotive Systems
- High Voltage Power Conversion
- Industrial Power Systems
- Battery Powered Systems

## TYPICAL APPLICATION

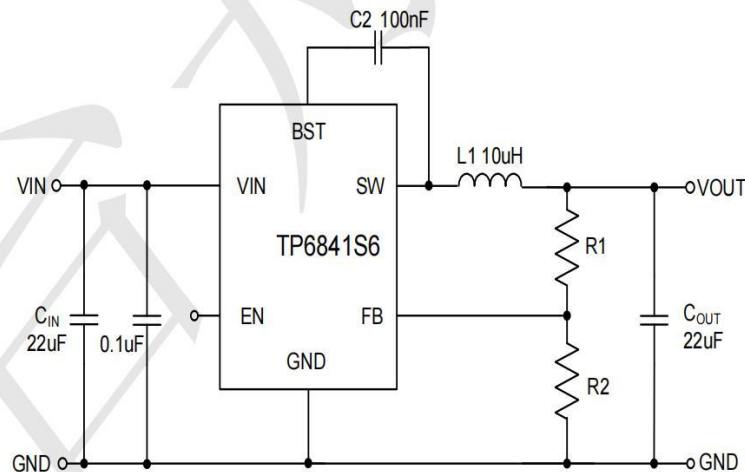

## PIN CONFIGURATION

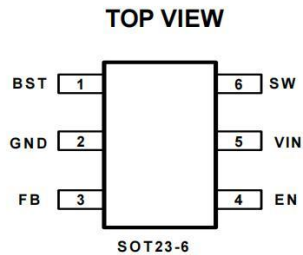

**Marking: 8xyy**

8= Device code  
xyy= date code

Pin Number	Pin Name	Function
SOT23-6L		
1	BST	Bootstrap pin. Connect a 100nF capacitor from this pin to SW.
2	GND	Ground.
3	FB	Feedback Input. Connect an external resistor divider from the output to FB and GND to set VOUT.
4	EN	Enable pin for the IC. Drive this pin high to enable the part, low to disable.
5	VIN	Supply Voltage. Bypass with a 22 $\mu$ F ceramic capacitor to GND.
6	SW	Inductor Connection. Connect an inductor Between SW and the regulator output.

## Absolute Maximum Rating ( $T_A=25^\circ\text{C}$ unless otherwise noted)

Parameter	Symbol	Maximum Rating	Unit	
Input Voltage	$V_{IN}$	$V_{SS}-0.3 \sim V_{SS}+45$	V	
SW Voltage	-	$V_{SS}-0.3 \sim V_{IN}+0.3$		
BST Voltage	-	$V_{SW}-0.3 \sim V_{SW} +6$		
FB Voltage	-	$V_{SS}-0.3 \sim V_{SS}+6$		
EN Voltage	-	$V_{SS}-0.3 \sim V_{SS}+45$		
Power Dissipation	$P_D$	SOT23-6L	600	mW
Thermal Resistance $\theta_{JC}$	$\theta_{JC}$	130		$^\circ\text{C}/\text{W}$
Thermal Resistance $\theta_{JA}$	$\theta_{JA}$	170		$^\circ\text{C}/\text{W}$
Operating Ambient Temperature	$T_{opr}$	-40 ~ 125		$^\circ\text{C}$
Storage Temperature	$T_{stg}$	-40 ~ +150		
ESD HBM (Human Body Mode)	-	2		KV

**Electrical Characteristics** (T<sub>A</sub> 25 °C unless otherwise noted)

Note: V<sub>IN</sub> = 12V, V<sub>OUT</sub> = 5.0V, unless otherwise specified. °C)

Parameter	Symbol	Condition	Min	Typ	Max	Unit
Input Voltage	V <sub>IN</sub>	-	4.5	-	40	V
VIN Under Voltage Protect	V <sub>UV</sub>	-	-	4.3	-	V
VIN Under Voltage Protect Hys.	V <sub>UV_hys</sub>	-	-	0.2	-	V
Supply Current	I <sub>Q1</sub>	V <sub>EN</sub> =2V, V <sub>FB</sub> =0.85V	-	40	60	μA
Supply Shutdown Current	I <sub>SD</sub>	-	-1	-	1	μA
FB Voltage	V <sub>FB</sub>	T <sub>A</sub> =25°C, 4.5V ≤ V <sub>IN</sub> ≤ 40V	0.776	0.8	0.824	V
Switching Frequency	F <sub>OSC</sub>	-	-	800	-	kHz
Minimum On Time	T <sub>ON_MIN</sub>	-	-	200	-	ns
Maximum Duty Cycle	D <sub>MAX</sub>	-	-	90	-	%
High Side Switch On Resistance	R <sub>DSON_H</sub>	-	-	450	-	mΩ
Low Side Switch On Resistance	R <sub>DSON_L</sub>	-	-	270	-	mΩ
High Side Current Limit	I <sub>LIM</sub>	-	-	2	-	A
EN Rising Threshold	V <sub>ENH</sub>	-	-	1.3	-	V
EN Falling Threshold	V <sub>ENL</sub>	-	-	1.2	-	V
EN Input Current	I <sub>EN</sub>	V <sub>EN</sub> =5V	-	2	-	uA
Thermal Shutdown	T <sub>SHD</sub>	-	-	160	-	°C
Thermal Shutdown Hys.	T <sub>SHD_hys</sub>	-	-	20	-	°C

**BLOCK DIAGRAM**

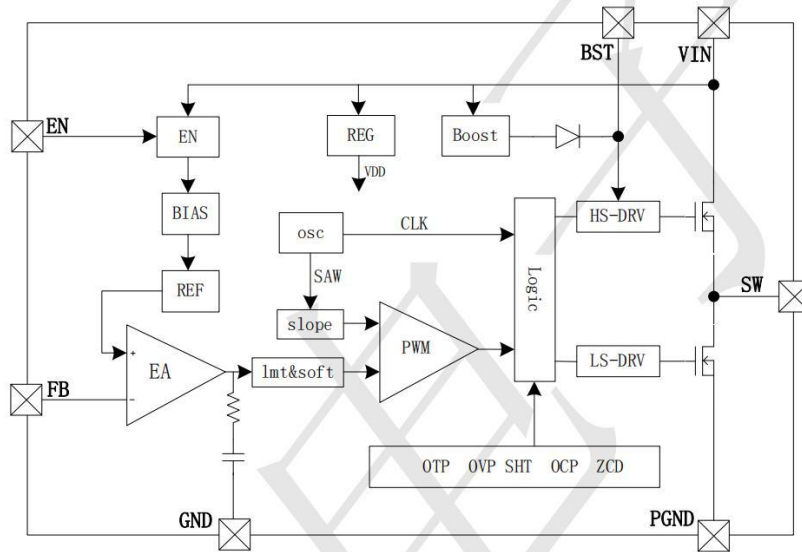

## TYPICAL PERFORMANCE CHARACTERISTICS

$V_{in}=12V$ ,  $V_{out}=5.0V$ ,  $L=10\mu H$ ,  $C_{out}=10\mu F$ ,  $T_A=+25^\circ C$ , unless otherwise noted.

### Efficient @ $V_{out}=5.0V$

$C_{VIN}=22\mu F$ ,  $C_{OUT}=10\mu F$ ,  $C_{BST}=0.1\mu F$ ,  $L_{IND}=10\mu H$

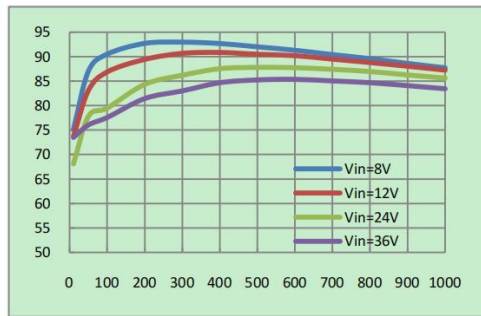

### Efficient @ $V_{out}=3.3V$

$C_{VIN}=22\mu F$ ,  $C_{OUT}=10\mu F$ ,  $C_{BST}=0.1\mu F$ ,  $L_{IND}=10\mu H$

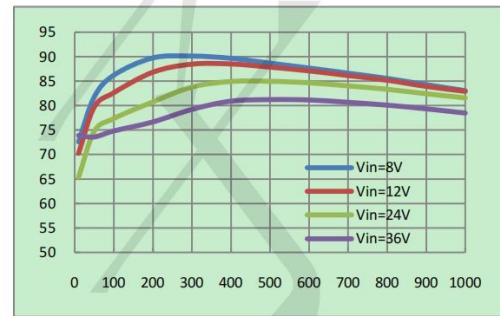

### Efficiency@ $V_{IN}=12V$

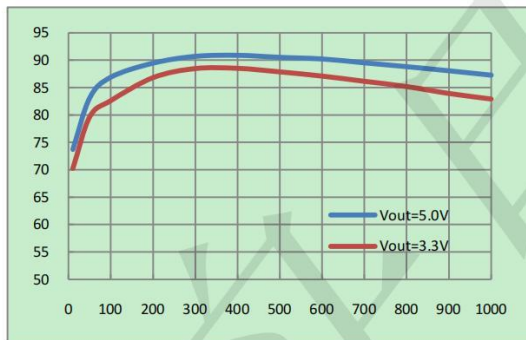

### Steady State Test

$V_{in}=12V$ ,  $V_{out}=5.0V$ ,  $I_{out}=800mA$

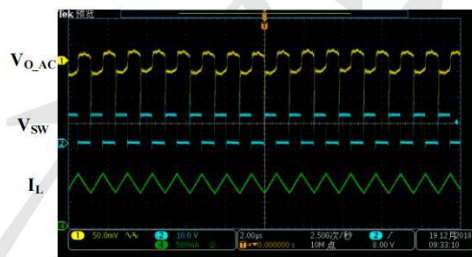

### Light Load Operation

$V_{in}=12V$ ,  $V_{out}=5.0V$ ,  $I_{out}=0A$

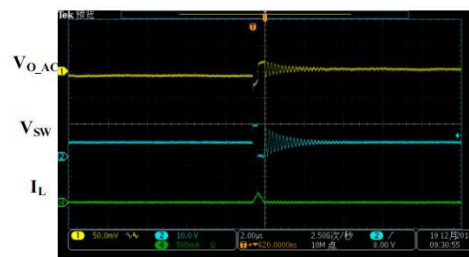

### Medium Load Operation

Vin=12V, Vout=5.0V, Iout=400mA

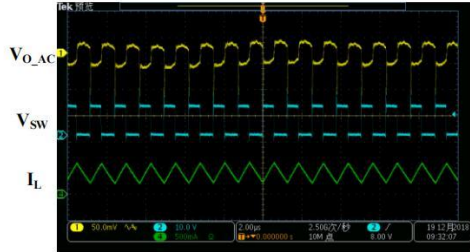

### Startup through Enable

Vin=12V, Vout=5.0V, Iout=800mA (Resistive load)

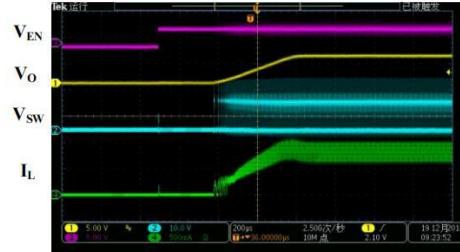

### Shutdown through Enable

Vin=12V, Vout=5.0V, Iout=800mA (Resistive load)

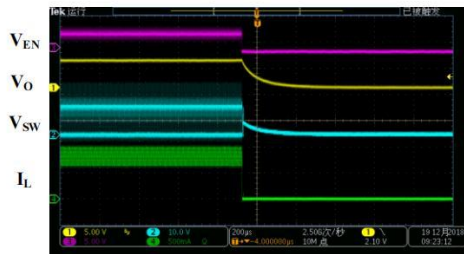

### Load Transient

Load: 300mA ->800mA ->300mA

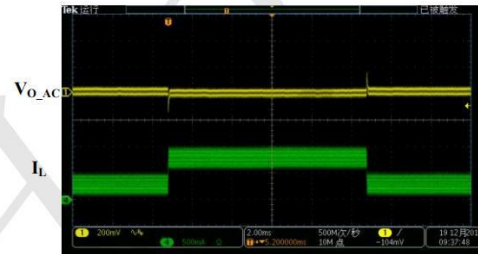

### Short Circuit Protection

Vin=12V, Vout=5.0V, Iout=800mA - Short

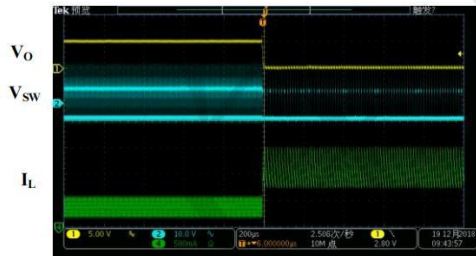

### Short Circuit Protection

Vin=12V, Vout=5.0V, Iout= Short - 800mA

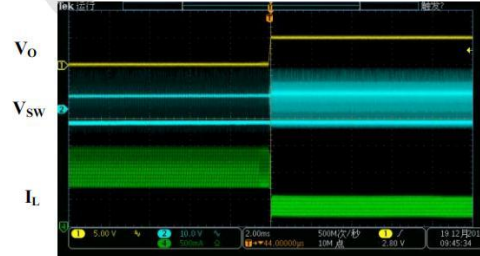

## FUNCTIONAL DESCRIPTION

The TP6841S6 is a synchronous, current-mode, step-down regulator. It regulates input voltages from 4.5V to 40V, and is capable of supplying up to 800mA of load current.

- **Current-Mode Control**

The TP6841S6 utilizes current-mode control to regulate the output voltage. The output voltage is measured at the FB pin through a resistive voltage divider and the error is amplified by the internal transconductance error amplifier. Output of the internal error amplifier is compared with the switch current measured internally to control the output current.

- **PFM Mode**

The TP6841S6 operates in PFM mode at light load. In PFM mode, switch frequency decreases when load current drops to boost power efficiency at light load by reducing switch-loss, while switch frequency increases when load current rises, minimizing output voltage ripples..

- **Shutdown Mode**

The TP6841S6 shuts down when voltage at EN pin is below 0.3V. The entire regulator is off and the supply current consumed by the TP6841S6 drops below 0.1uA.

- **Power Switch**

N-Channel MOSFET switches are integrated on the TP6841S6 to down convert the input voltage to the regulated output voltage. Since the top MOSFET needs a gate voltage great than the input voltage, a boost capacitor connected between BST and SW pins is required to drive the gate of the top switch. The boost capacitor is charged

### ■ Application Information

- **Setting the Output Voltage**

The external resistor divider is used to set the output voltage. Choose R1 and R2 follow the next table or calculated by following equation, where the internal reference voltage  $V_{REF}=0.8V$ .

$$\frac{R1}{R2} = \frac{V_{OUT} - V_{REF}}{V_{REF}}$$

$V_{OUT}(V)$	$R2(k\Omega)$	$R1(k\Omega)$
2.5	24	51
3.3	24	75
5.0	24	126

by the internal 4.0V rail when SW is low.

- **Vin Under Voltage Protection**

A resistive divider can be connected between Vin and ground, with the central tap connected to EN, so that when Vin drops to the pre-set value, EN drops below 1.2V to trigger input under voltage lockout protection.

- **Over-Current-Protection and Hiccup**

At start-up, due to the high voltage at input and low voltage at output, current inertia of the output inductance can be easily built up, resulting in a large start-up output current. In the TP6841S6 used current limit of low side power mosfet to control the output current at start-up.

- **Output Short Protection**

When output is shorted to ground, output current rapidly reaches its peak current limit and the top power switch is turned off. And the bottom power switch is turned on and stay on until the output current falls below the current limit. When output current is below the current limit, the top power switch will be turned on again and if the output short is still present, the top power switch is turned off when the peak current limit is reached and the bottom power switch is turned on. This cycle goes on until the output short is removed and the regulator comes into normal operation again.

- **Thermal Protection**

When the temperature of the TP6841S6 rises above 160°C, it is forced into thermal shut-down. Only when core temperature drops below 140°C can the regulator becomes active again

- **Inductor Selection**

A 4.7μH to 22μH inductor with a DC current rating of at least 25% percent higher than the maximum load current is recommended for most applications. For highest efficiency, the inductor DC resistance should be less than 15mΩ. For most designs, the inductance value can be derived from the following equation.

$$L > \frac{V_{OUT} \times (V_{IN} - V_{OUT})}{V_{IN} \times \Delta I_L \times f_{OSC}}$$

Where  $\Delta I_L$  is the inductor ripple current.

Choose  $\Delta I_L$  to be approximately 30% of the maximum load current.

Under light load conditions below 100mA, larger inductance is recommended for improved efficiency.

Note: If the output voltage is less than 2.5V, it is recommended to use a larger inductance and add a small capacitance (10nF) parallel to R1.

● **Input Capacitor Selection**

The input capacitor reduces the surge current drawn from the input and switching noise from the device. The input capacitor impedance at the switching frequency should be less than input source impedance to prevent high frequency switching current passing to the input. A low ESR input capacitor sized for maximum RMS current must be used. Ceramic capacitors with X5R or X7R dielectrics are highly recommended because of their low ESR and small temperature coefficients. A 22µF ceramic capacitor for most applications is sufficient. Include a capacitor with a value of 0.1 µF for high-frequency filtering and place it as close as possible to the device pins.

● **Output Capacitor Selection**

■ **Application Information**

For minimum noise problem and best operating performance, the PCB is preferred to following the guidelines as reference.

1. Place the input decoupling capacitor as close to TP6841S6 (VIN pin and GND) as possible to eliminate noise at the input pin. The loop area formed by input capacitor and GND must be minimized.
2. Put the feedback trace as far away from the inductor and noisy power traces as possible.
3. The ground plane on the PCB should be as large as possible for better heat dissipation.

The output capacitor (C<sub>OUT</sub>) is required to maintain the DC output voltage, and the capacitance value determines the output ripple voltage. The output voltage ripple can be calculated by:

$$\Delta V_{OUT} = \frac{V_{OUT} \times (V_{IN} - V_{OUT})}{V_{IN} \times f_{OSC} \times L} \times (R_{ESR} + \frac{1}{8 \times f_{OSC} \times C_{OUT}})$$

Where L is the inductor value and R<sub>ESR</sub> is the equivalent series resistance (ESR) value of the output capacitor.

The output capacitor can be low ESR electrolytic, tantalum or ceramic, which lower ESR capacitors get lower output ripple voltage.

The characteristics of the output capacitor also affect the stability of the regulation system, and a 10µF ceramic capacitor is recommended in typical application. The TP6841S6 can be optimized for a wide range of capacitance and ESR values.

■ **Reference Design**

**Reference 1:**

V<sub>IN</sub> : 5.0V-40V  
V<sub>OUT</sub> : 3.3V  
I<sub>OUT</sub> : 0-800mA

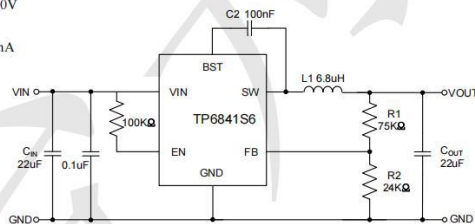

**Reference 2:**

V<sub>IN</sub> : 6.5V-40V  
V<sub>OUT</sub> : 5.0V  
I<sub>OUT</sub> : 0-800mA

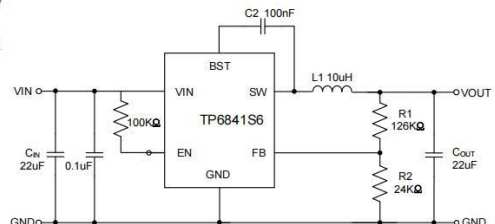



Package information

[www.sot23.com.tw](http://www.sot23.com.tw)

SOT23-6

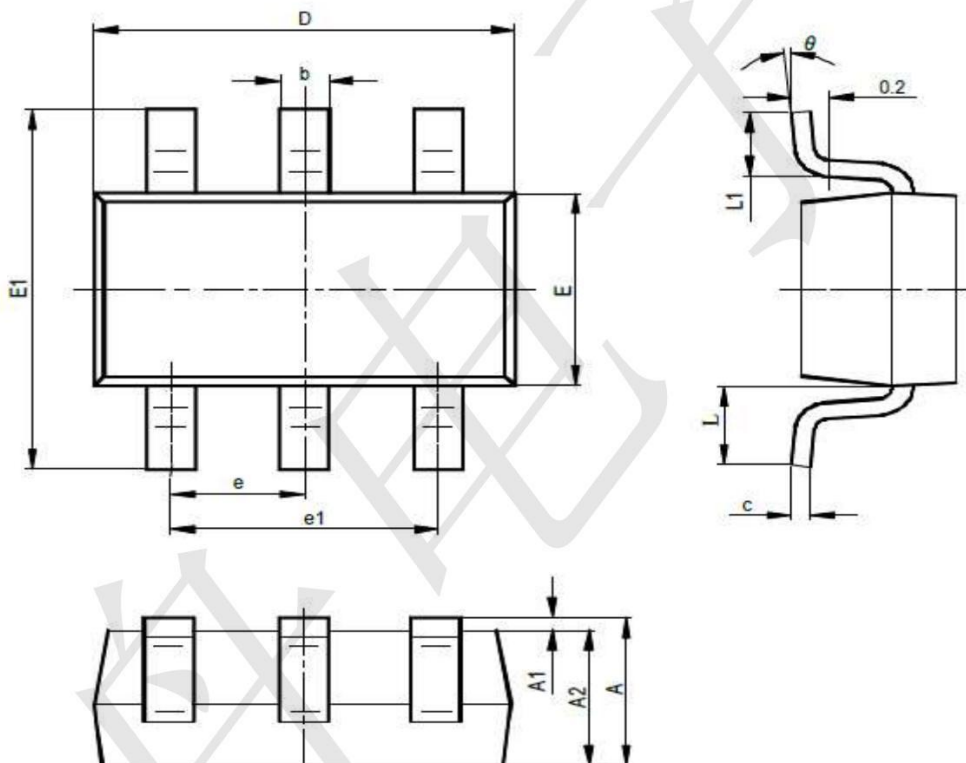

SYMBOL	MILLIMETERS		INCHES	
	MIN	MAX	MIN	MAX
A	1.050	1.250	0.041	0.049
A1	0.000	0.100	0.000	0.004
A2	1.050	1.150	0.041	0.045
b	0.300	0.400	0.012	0.016
c	0.100	0.200	0.004	0.008
D	2.820	3.020	0.111	0.119
E	1.500	1.700	0.059	0.067
E1	2.650	2.950	0.104	0.116
e	0.950TYP		0.037TYP	
e1	1.800	2.000	0.071	0.079
L	0.700REF		0.028REF	
L1	0.300	0.600	0.012	0.024
θ	0°	8°	0°	8°

## X-ON Electronics

Largest Supplier of Electrical and Electronic Components

*Click to view similar products for [Switching Controllers](#) category:*

*Click to view products by [TECH PUBLIC](#) manufacturer:*

Other Similar products are found below :

[LV5065VB-TLM-H](#) [LV5066V-TLM-H](#) [LV5725JAZ-AH](#) [NCP1218AD65R2G](#) [NCP1244BD065R2G](#) [NCP1336ADR2G](#) [NCP6153MNTWG](#)  
[NCP81005MNTWG](#) [NCP81101BMNTXG](#) [NCP81205MNTXG](#) [SJ6522AG](#) [SJE6600](#) [AZ7500BMTR-E1](#) [IR35215MTRPBF](#) [SG3845DM](#)  
[NCP4204MNTXG](#) [NCP6132AMNR2G](#) [NCP81102MNTXG](#) [NCP81206MNTXG](#) [UBA2051C](#) [NCP1240AD065R2G](#) [NCP1240FD065R2G](#)  
[NCP1361BABAYSNT1G](#) [NCP1230P100G](#) [NX2124CSTR](#) [SG2845M](#) [NCP1366BABAYDR2G](#) [NCP81101MNTXG](#) [TEA19362T/1J](#)  
[NCP81174NMNTXG](#) [NCP4308DMTTWG](#) [NCP4308DMNTWG](#) [NCP4308AMTTWG](#) [NCP1366AABAYDR2G](#) [NCP1251FSN65T1G](#)  
[NCP1246BLD065R2G](#) [iW1760B-10](#) [MB39A136PFT-G-BND-ERE1](#) [NCP1256BSN100T1G](#) [LV5768V-A-TLM-E](#) [NCP1365BABCYDR2G](#)  
[NCP1365AABCYDR2G](#) [MCP1633T-E/MG](#) [NCV1397ADR2G](#) [NCP81599MNTXG](#) [NCP1246ALD065R2G](#) [AZ494AP-E1](#)  
[XDPL8219XUMA1](#) [TLD55421QVXUMA1](#) [MP6908LGJ-P](#)