

■ Features

- Maximum output current
 $I_{OM}: 0.1A$
- Output voltage
 $V_O: 5V$
- Continuous total dissipation
 $P_D: 0.6 W (T_a = 25^\circ C)$

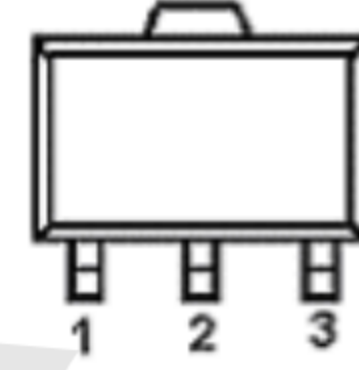

1.OUT
2.GND
3.IN

■ Absolute Maximum Ratings $T_a = 25^\circ C$

Parameter	Symbol	Value	Unit
Input Voltage	V_i	30	V
Thermal Resistance from Junction to Ambient	$R_{\theta JA}$	160	$^\circ C/W$
Operating Junction Temperature Range	T_{OPR}	-40~+125	$^\circ C$
Storage Temperature Range	T_{STG}	-65~+150	$^\circ C$

■ Electrical Characteristics ($V_i=10V, I_o=40mA, 0^\circ C < T_j < 125^\circ C, C_1=0.33 \mu F, C_o=0.1 \mu F$, unless otherwise specified)

Parameter	Symbol	Test conditions	Min	Typ	Max	Unit		
Output voltage	V_o		25 $^\circ C$	4.80	5.0	5.20	V	
				4.85	5.0	5.15	V	
		$7V \leq V_i \leq 20V, I_o = 1mA \sim 40mA$	0-125 $^\circ C$		4.90	5.0	5.10	V
				$I_o = 1mA \sim 70mA$	4.75	5.0	5.25	V
Load Regulation	ΔV_o	$I_o = 1mA \sim 100mA$	25 $^\circ C$	15	60	mV		
		$I_o = 1mA \sim 40mA$	25 $^\circ C$	8	30	mV		
Line regulation	ΔV_o	$7V \leq V_i \leq 20V$	0-125 $^\circ C$	32	150	mV		
		$8V \leq V_i \leq 20V$	25 $^\circ C$	26	100	mV		
Quiescent Current	I_q		25 $^\circ C$	3.8	6	mA		
Quiescent Current Change	ΔI_q	$8V \leq V_i \leq 20V$	0-125 $^\circ C$		1.5	mA		
		$1mA \leq I_o \leq 40mA$	0-125 $^\circ C$		0.1			
Output Noise Voltage	V_N	$10Hz \leq f \leq 100KHz$	25 $^\circ C$	42		$\mu V/V_o$		
Ripple Rejection	RR	$8V \leq V_i \leq 20V, f=120Hz$	0-125	41	49	dB		
Dropout Voltage	V_d		25 $^\circ C$	1.7		V		

■ Typical application.

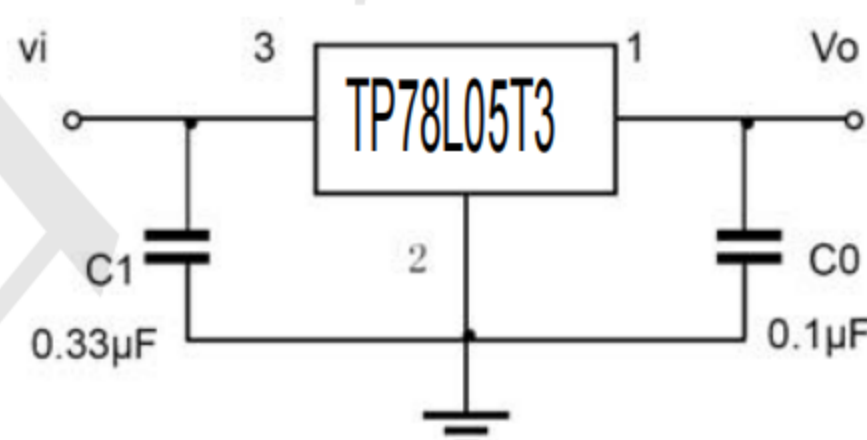

Typical Electrical Characteristic Curves

Output Characteristics

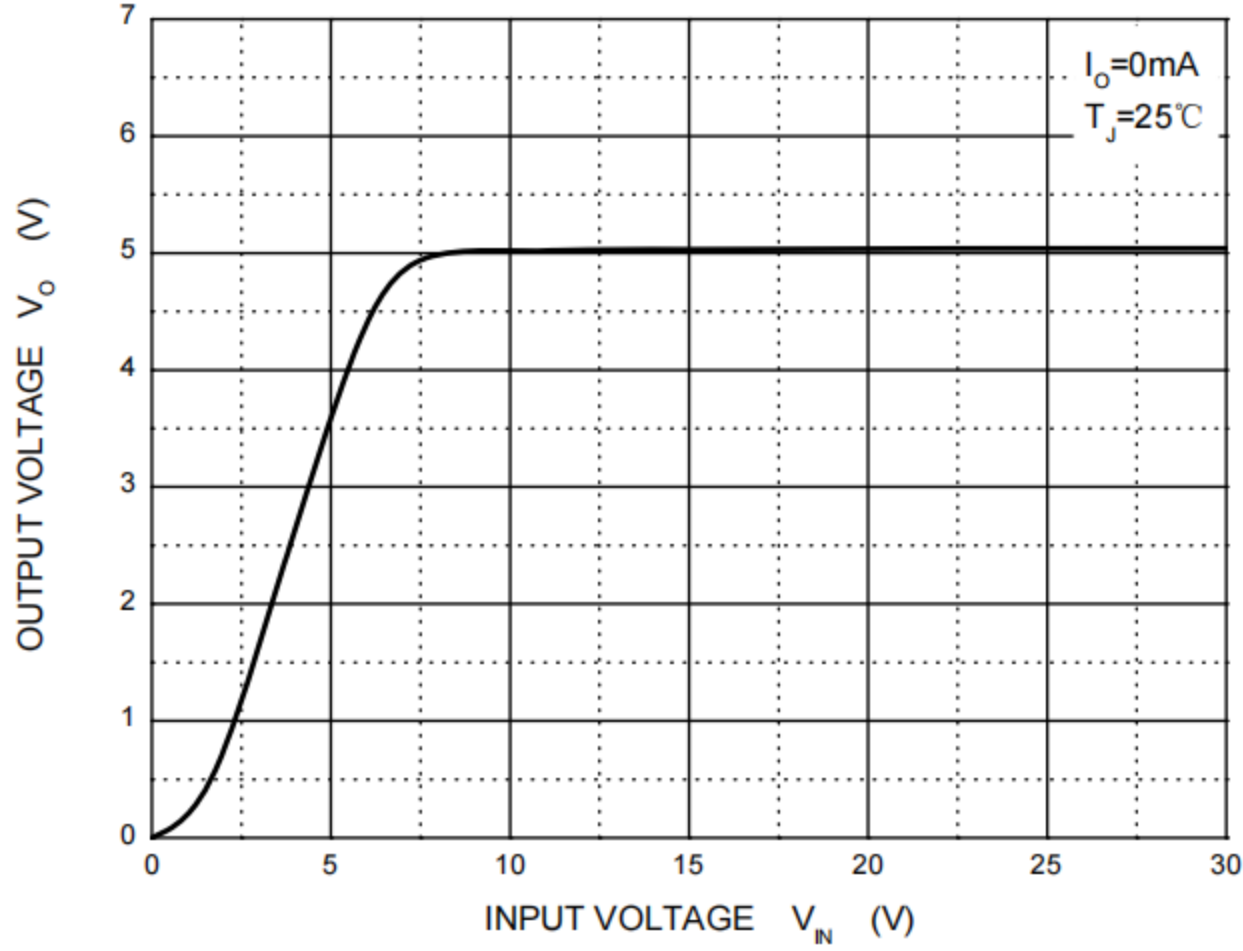

Dropout Characteristics

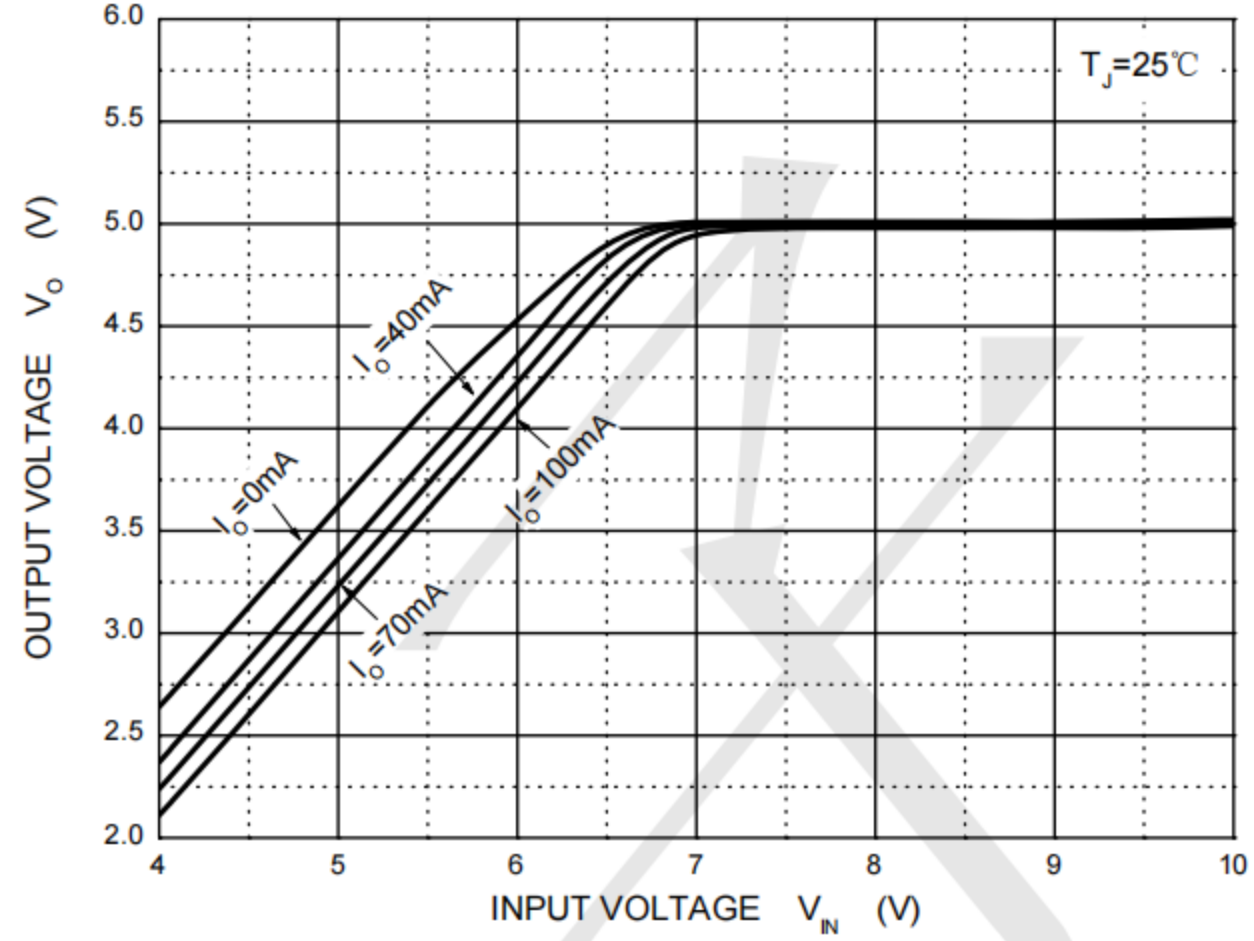

Quiescent Current vs Input Voltage

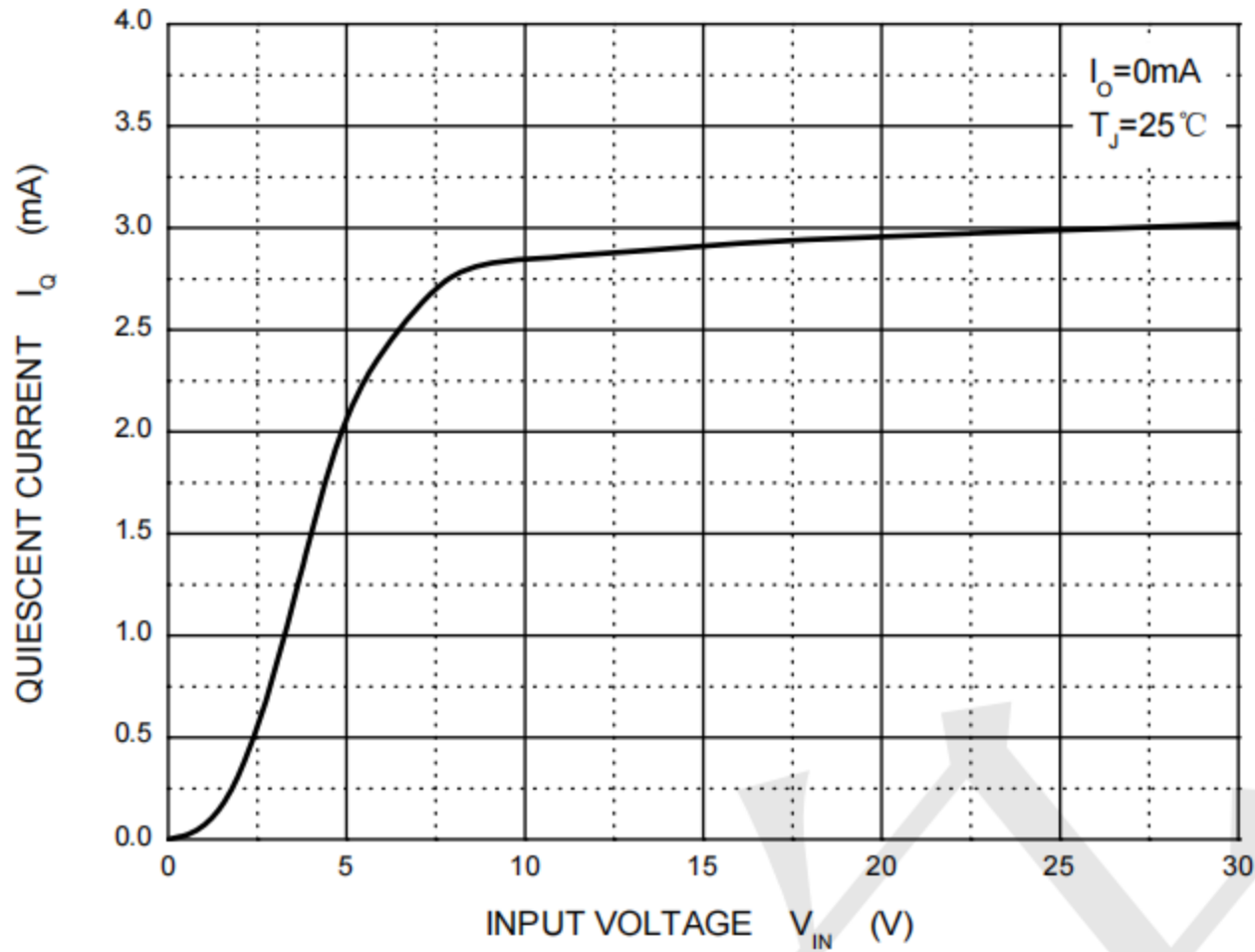

Current Cut-off Grid Voltage

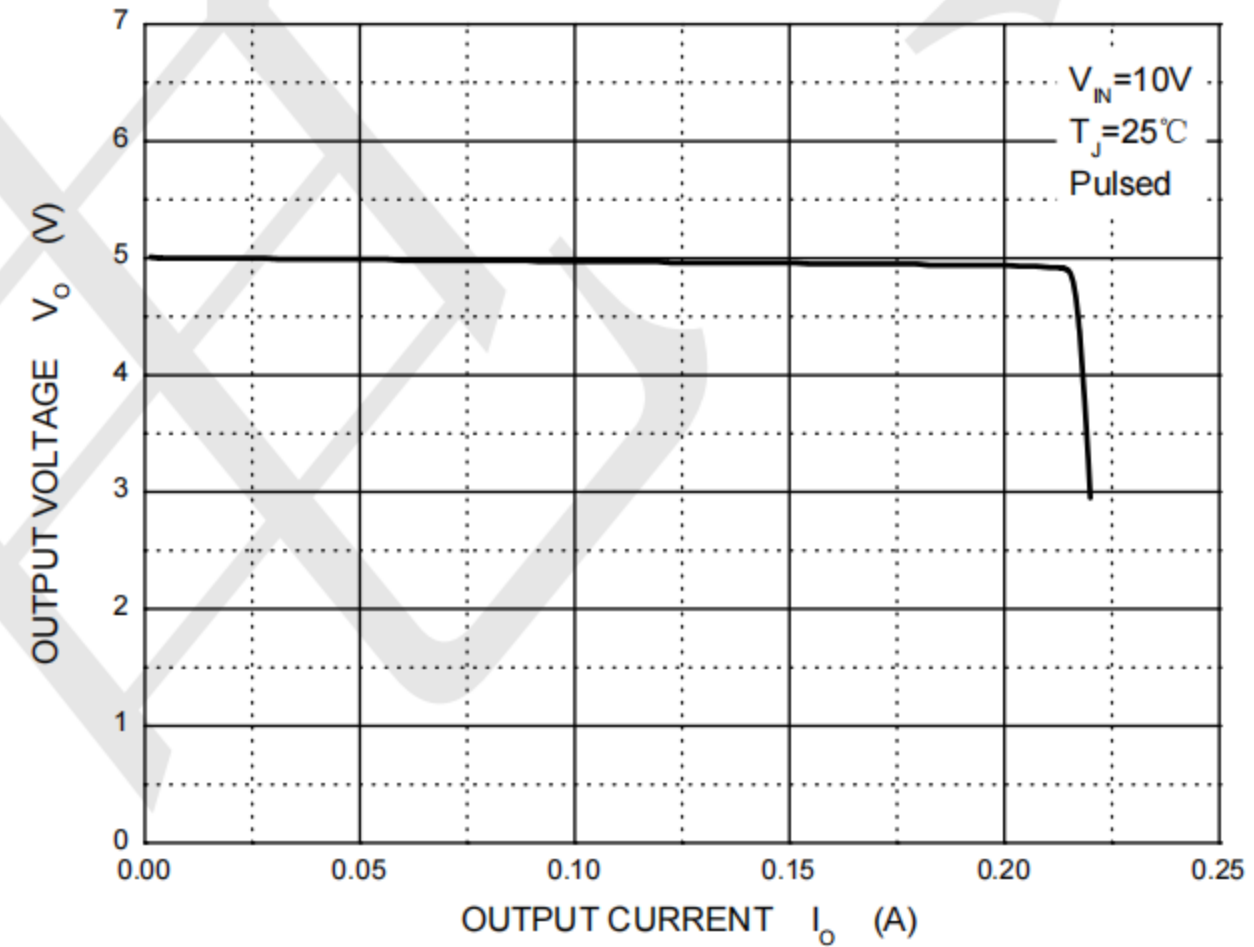

Output Voltage vs Junction Temperature

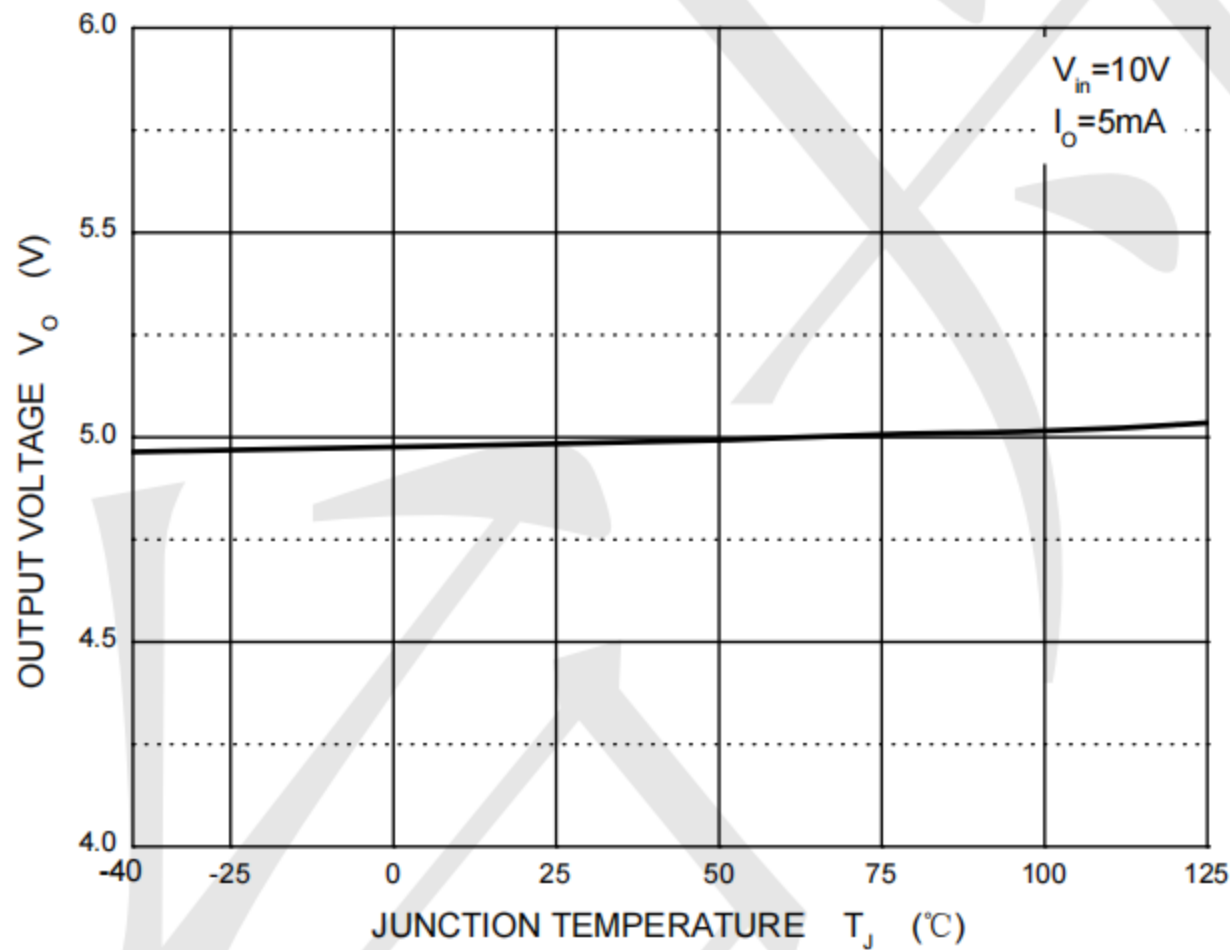

Power Derating Curve

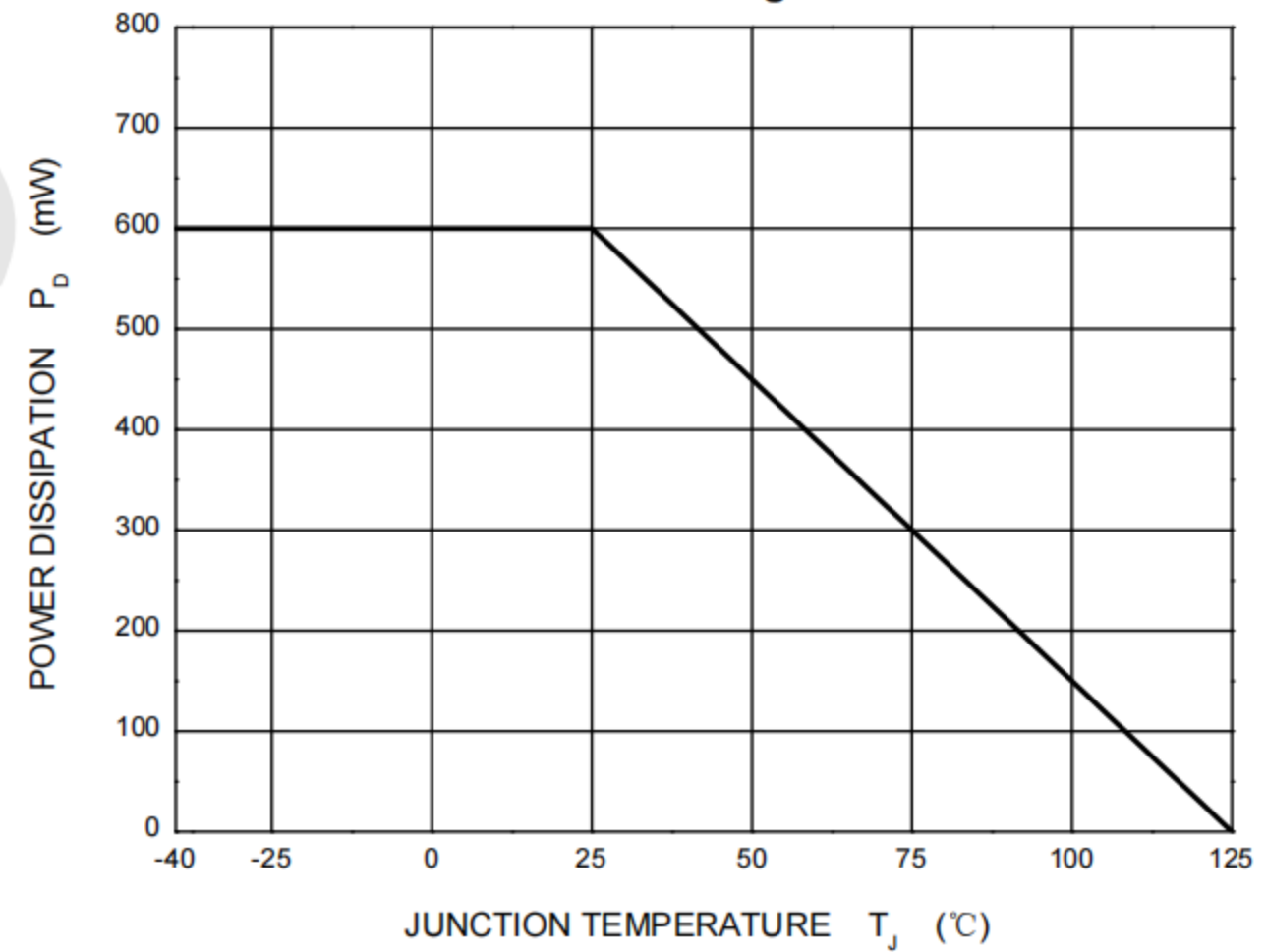



Package information

SOT89-3

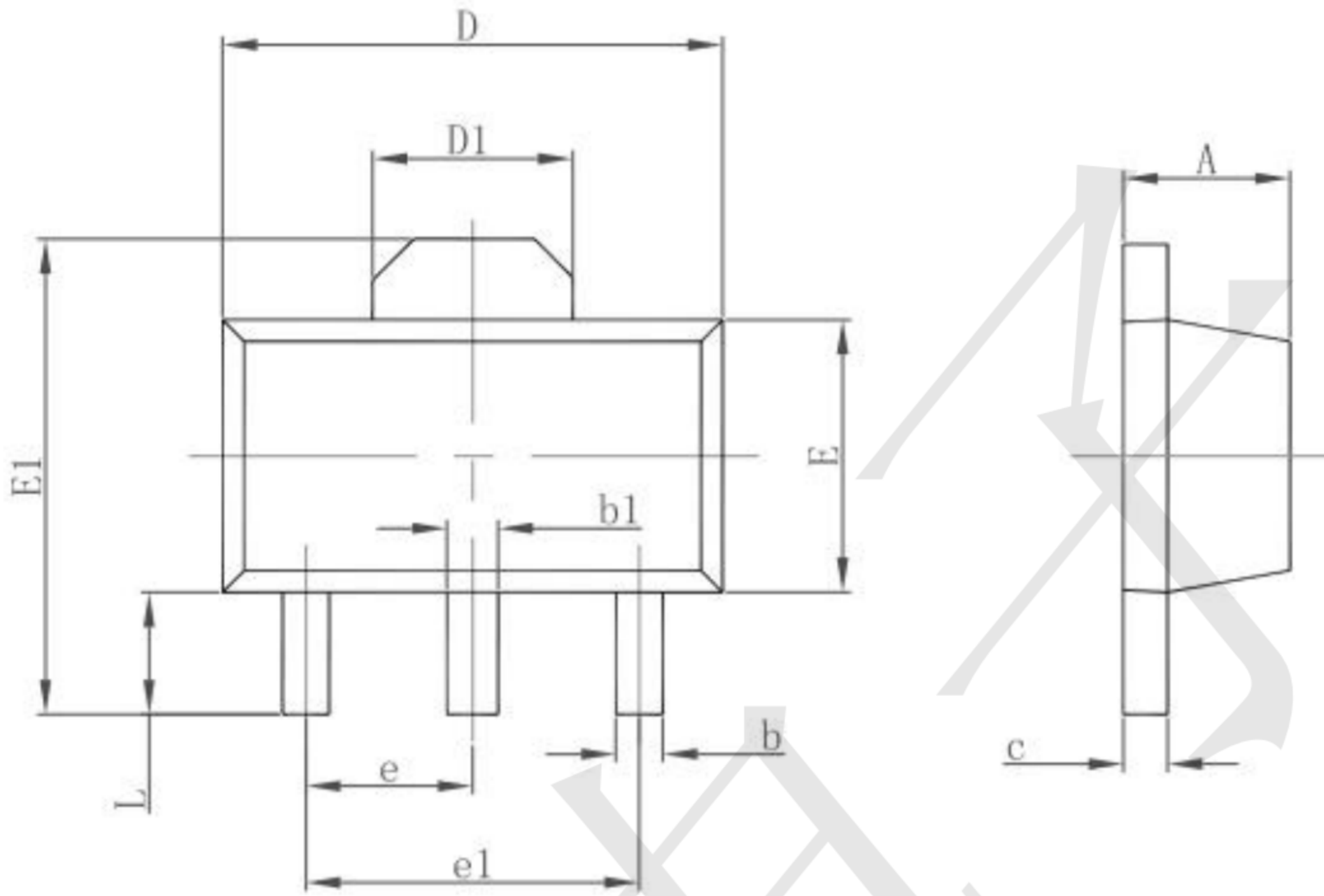

Symbol	Dimensions In Millimeters		Dimensions In Inches	
	Min.	Max.	Min.	Max.
A	1.400	1.600	0.055	0.063
b	0.320	0.520	0.013	0.020
b1	0.400	0.580	0.016	0.023
c	0.350	0.440	0.014	0.017
D	4.400	4.600	0.173	0.181
D1	1.550 REF.		0.061 REF.	
E	2.300	2.600	0.091	0.102
E1	3.940	4.250	0.155	0.167
e	1.500 TYP.		0.060 TYP.	
e1	3.000 TYP.		0.118 TYP.	
L	0.900	1.200	0.035	0.047

X-ON Electronics

Largest Supplier of Electrical and Electronic Components

Click to view similar products for [Linear Voltage Regulators](#) category:

Click to view products by [TECH PUBLIC](#) manufacturer:

Other Similar products are found below :

[LV5684PVD-XH](#) [MCDTSA6-2R](#) [L7815ACV-DG](#) [LV56801P-E](#) [UA7805CKC](#) [714954EB](#) [ZMR500QFTA](#) [BA033LBSG2-TR](#)
[NCV78M05ABDTRKG](#) [LV5680P-E](#) [L79M05T-E](#) [L78LR05D-MA-E](#) [NCV317MBTG](#) [NTE7227](#) [MP2018GZD-33-P](#) [MP2018GZD-5-P](#)
[LV5680NPVC-XH](#) [ZTS6538SE](#) [UA78L09CLP](#) [UA78L09CLPR](#) [CAT6221-PPTD-GT3](#) [MC78M09CDTRK](#) [NCV51190MNTAG](#)
[BL1118CS8TR1833](#) [BL8563CKETR18](#) [BL8077CKETR33](#) [BL9153-33CC3TR](#) [BL9161G-15BADRN](#) [BL9161G-28BADRN](#)
[BRCO7530MMC](#) [CJ7815B-TFN-ARG](#) [LM317C](#) [GM7333K](#) [GM7350K](#) [XC6206P332MR](#) [HT7533](#) [LM7912S/TR](#) [LT1764S/TR](#) [LM7805T](#)
[LM338T](#) [LM1117IMP-3.3/TR](#) [HT1117AM-3.3](#) [HT7550S](#) [AMS1117-3.3](#) [HT7150S](#) [78L12](#) [HT7550](#) [HT7533-1](#) [HXY6206I-2.5](#) [HT7133](#)