

■ Features

Maximum Output current

I_{OM} : 0.1 A

Output voltage

V_o : 12 V

Continuous total dissipation

P_D : 0.50 W

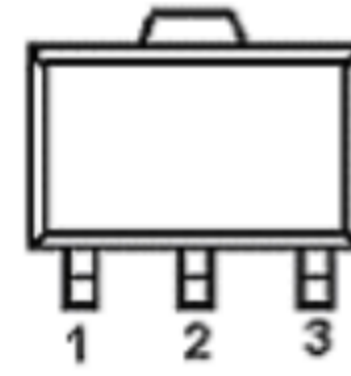

1.OUT
2.GND
3.IN

Marking:78L12

■ Absolute Maximum Ratings $T_a = 25^\circ\text{C}$

Parameter	Symbol	Value	Unit
Input Voltage	V_i	35	V
Operating Junction Temperature Range	T_{OPR}	0~+150	$^\circ\text{C}$
Storage Temperature Range	T_{STG}	-55~+150	$^\circ\text{C}$

■ Electrical Characteristics ($V_i=10\text{V}, I_o=40\text{mA}, 0^\circ\text{C}<T_j<125^\circ\text{C}, C_1=0.33\mu\text{F}, C_o=0.1\mu\text{F}$, unless otherwise specified)

Parameter	Symbol	Test conditions	MIN	TYP	MAX	UNIT	
Output voltage	V_o	25°C	11.5	12	12.5	V	
		$14\text{V}\leq V_i\leq 27\text{V}, I_o=1\text{mA}-40\text{mA}$	0-125 $^\circ\text{C}$	11.4	12	12.6	V
		$I_o=1\text{mA}-70\text{mA}$		11.4	12	12.6	V
Load Regulation	ΔV_o	$I_o=1\text{mA}-100\text{mA}$	25 $^\circ\text{C}$	22	100	mV	
		$I_o=1\text{mA}-40\text{mA}$	25 $^\circ\text{C}$	13	50	mV	
Line regulation	ΔV_o	$14.5\text{V}\leq V_i\leq 27\text{V}$	25 $^\circ\text{C}$	55	250	mV	
		$16\text{V}\leq V_i\leq 27\text{V}$	25 $^\circ\text{C}$	49	200	mV	
Quiescent Current	I_q		25 $^\circ\text{C}$	4.3	6.5	mA	
Quiescent Current Change	ΔI_q	$16\text{V}\leq V_i\leq 27\text{V}$	0-125 $^\circ\text{C}$		1.5	mA	
	ΔI_q	$1\text{mA}\leq I_o\leq 40\text{mA}$	0-125 $^\circ\text{C}$		0.1	mA	
Output Noise Voltage	V_N	10Hz $\leq f\leq$ 100KHz	25 $^\circ\text{C}$	70		μV	
Ripple Rejection	RR	$15\text{V}\leq V_i\leq 25\text{V}, f=120\text{Hz}$	0-125 $^\circ\text{C}$	37	42	dB	
Dropout Voltage	V_d		25 $^\circ\text{C}$	1.7		V	

■ Typical application.

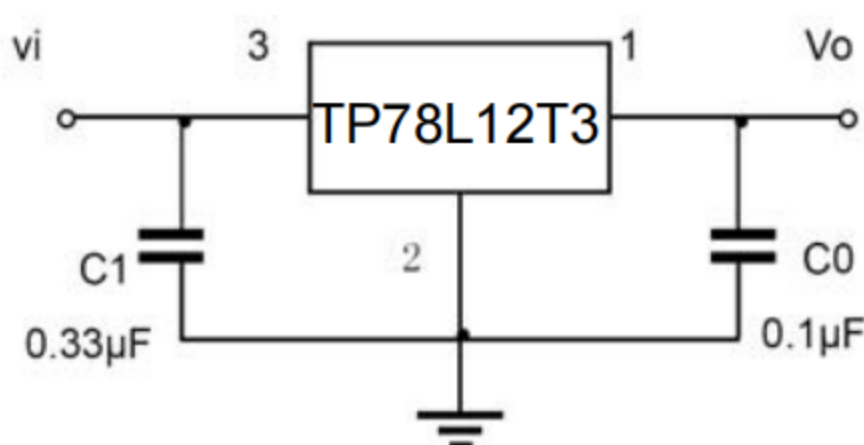

Typical Electrical Characteristic Curves

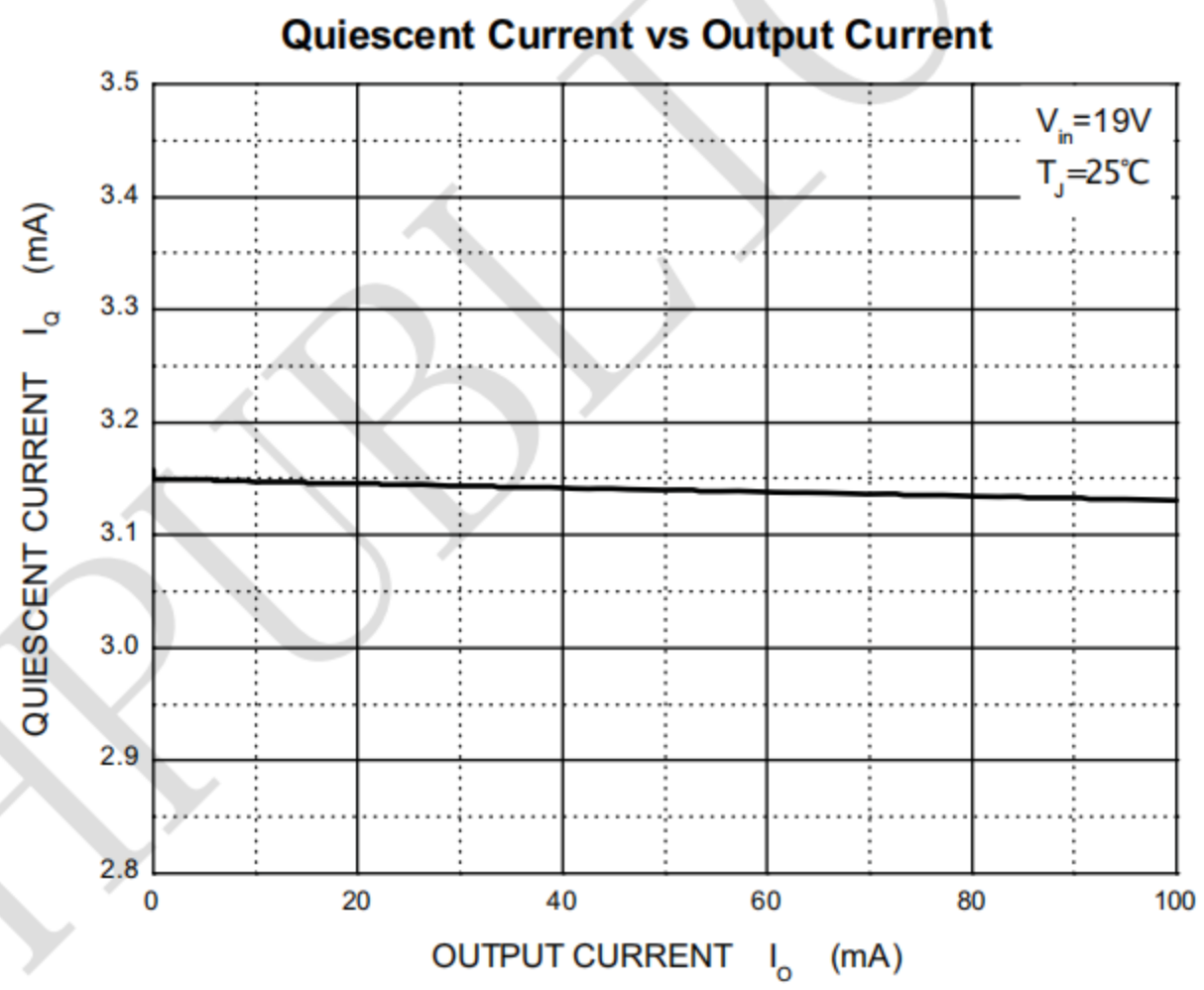
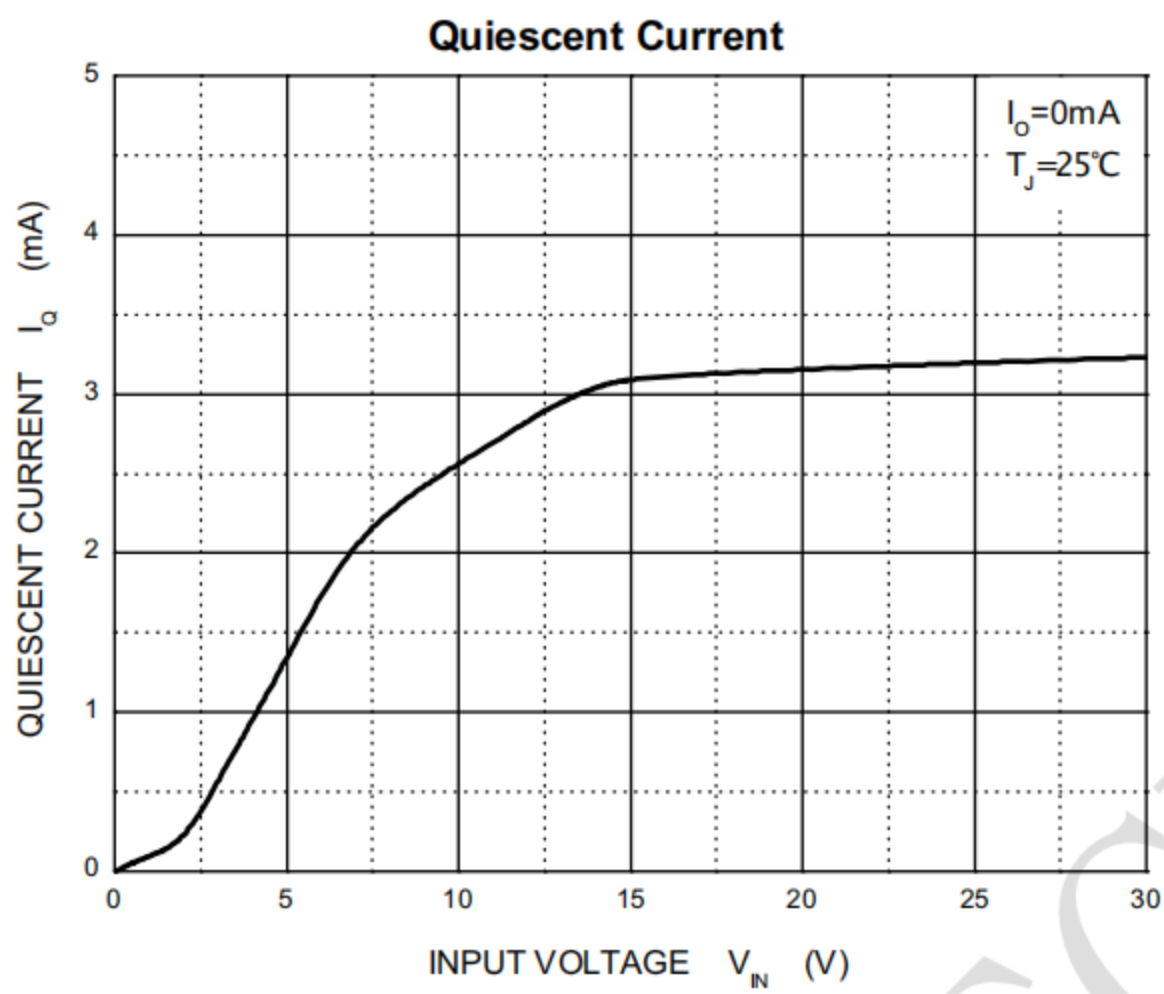
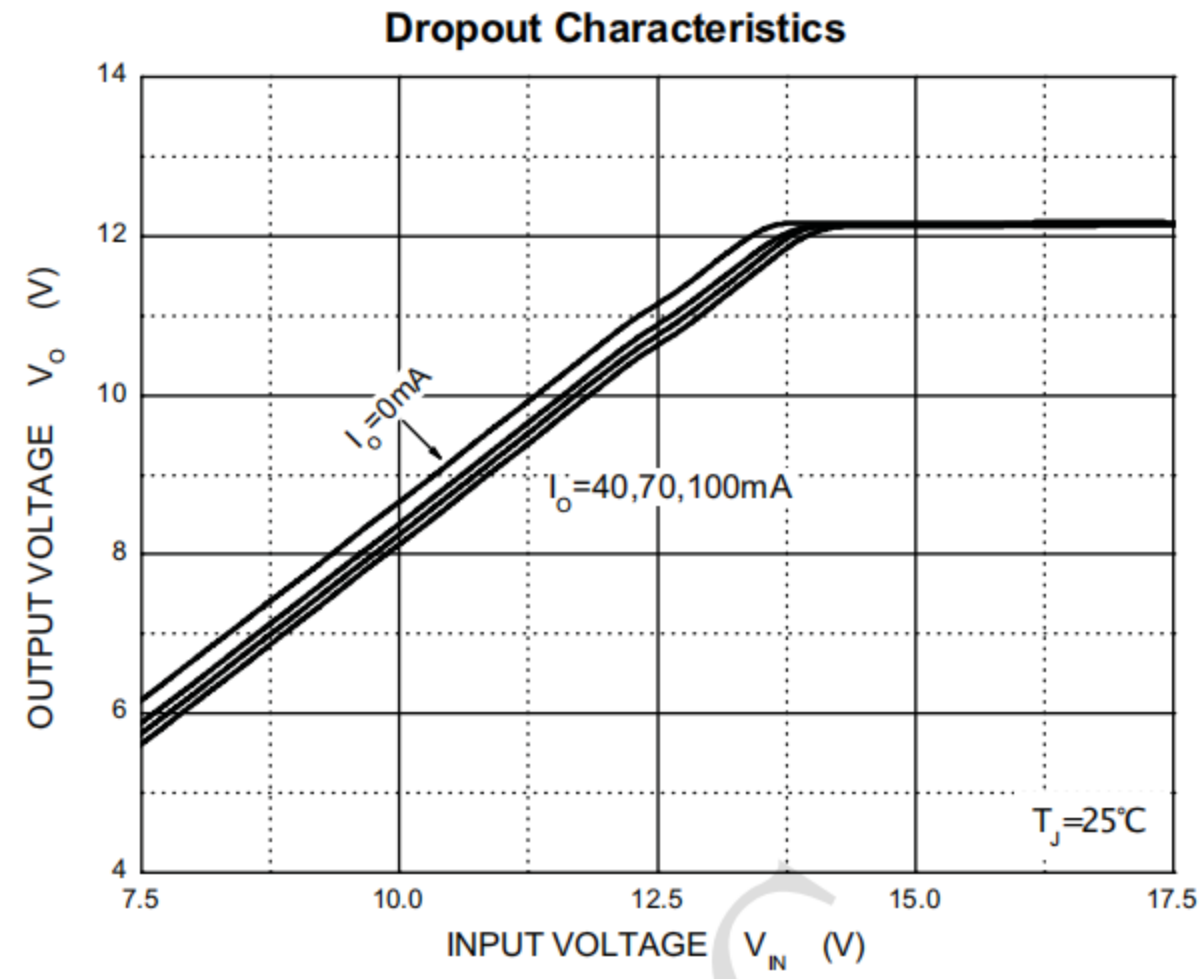
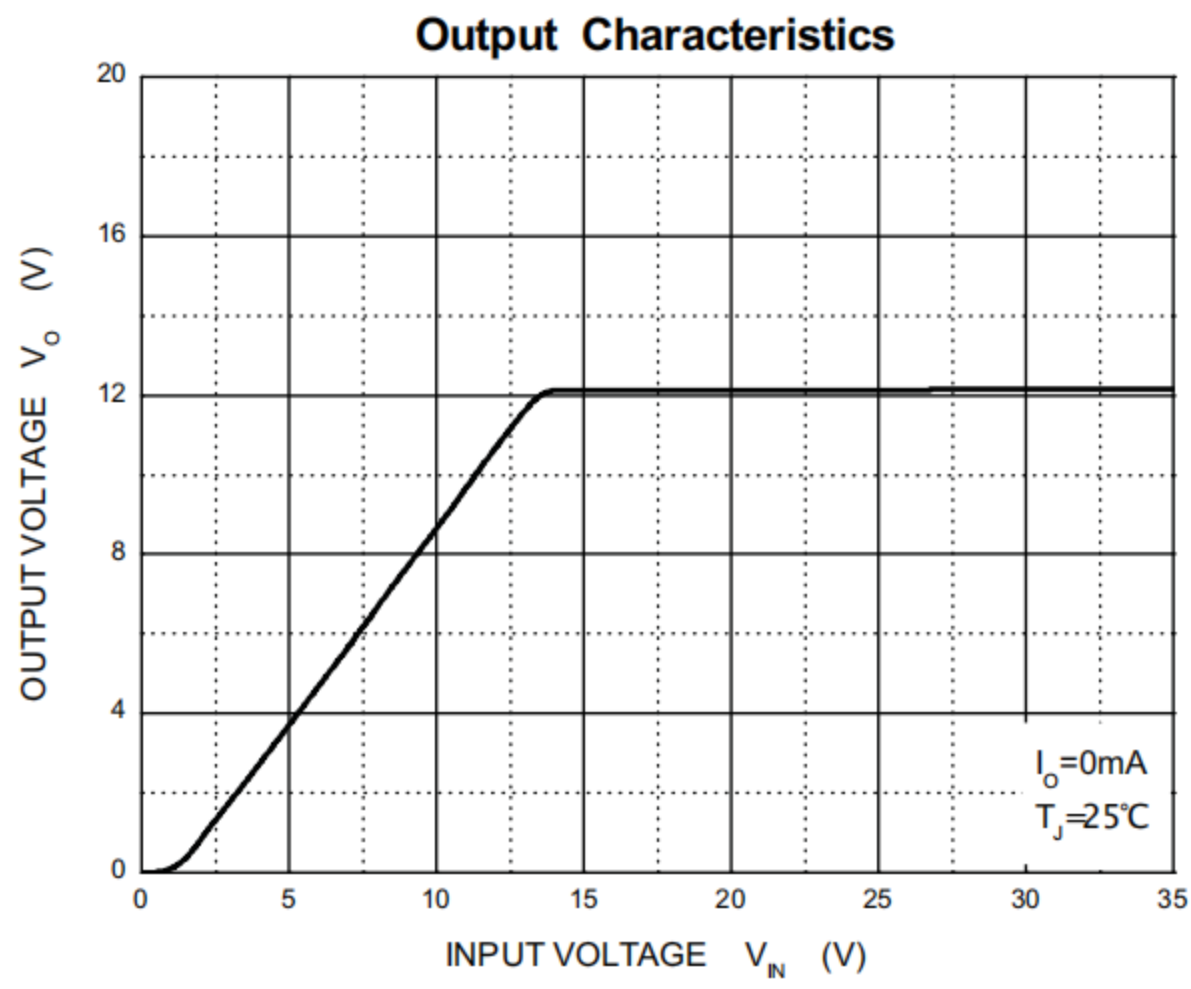

Typical Electrical Characteristic Curves

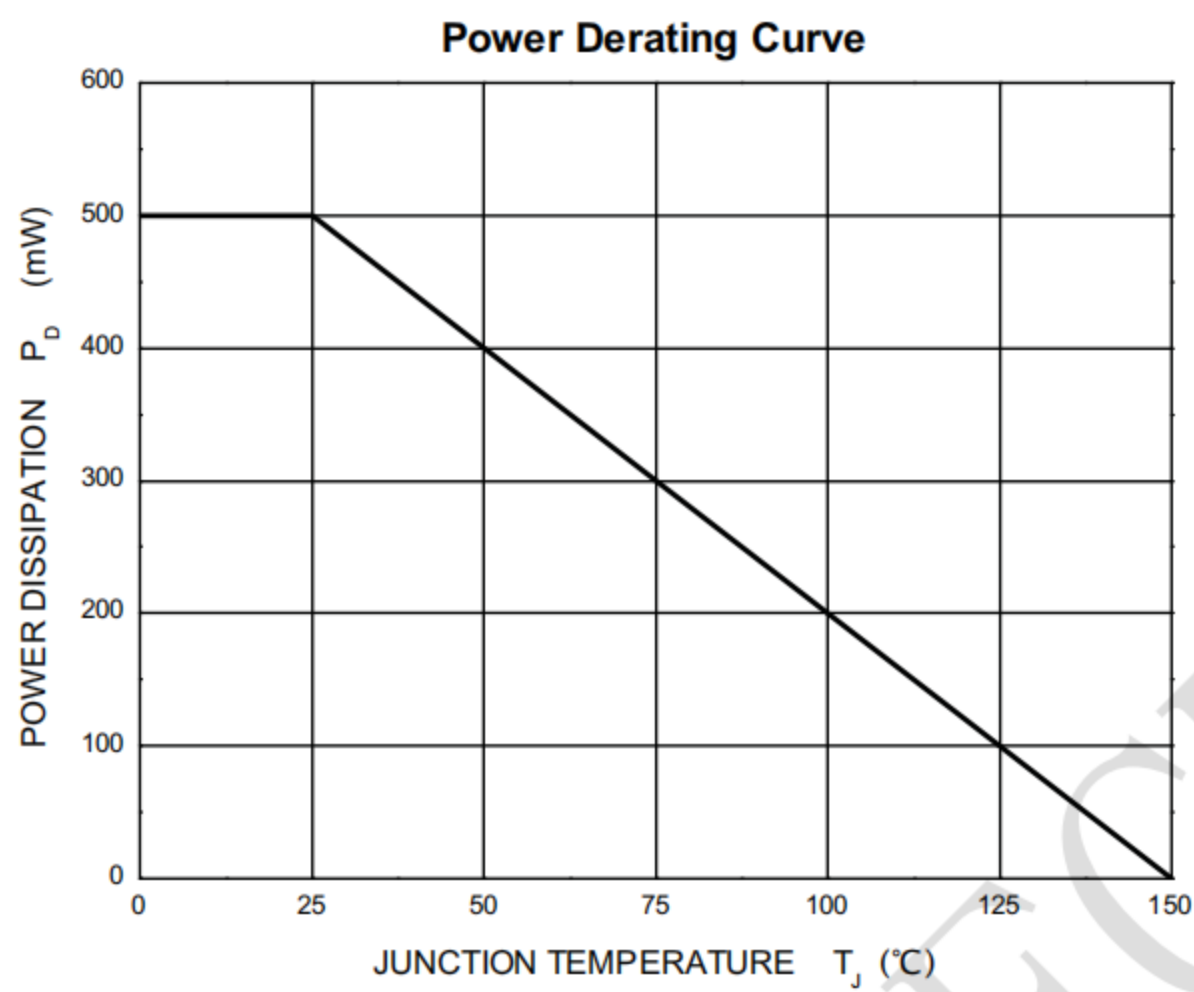
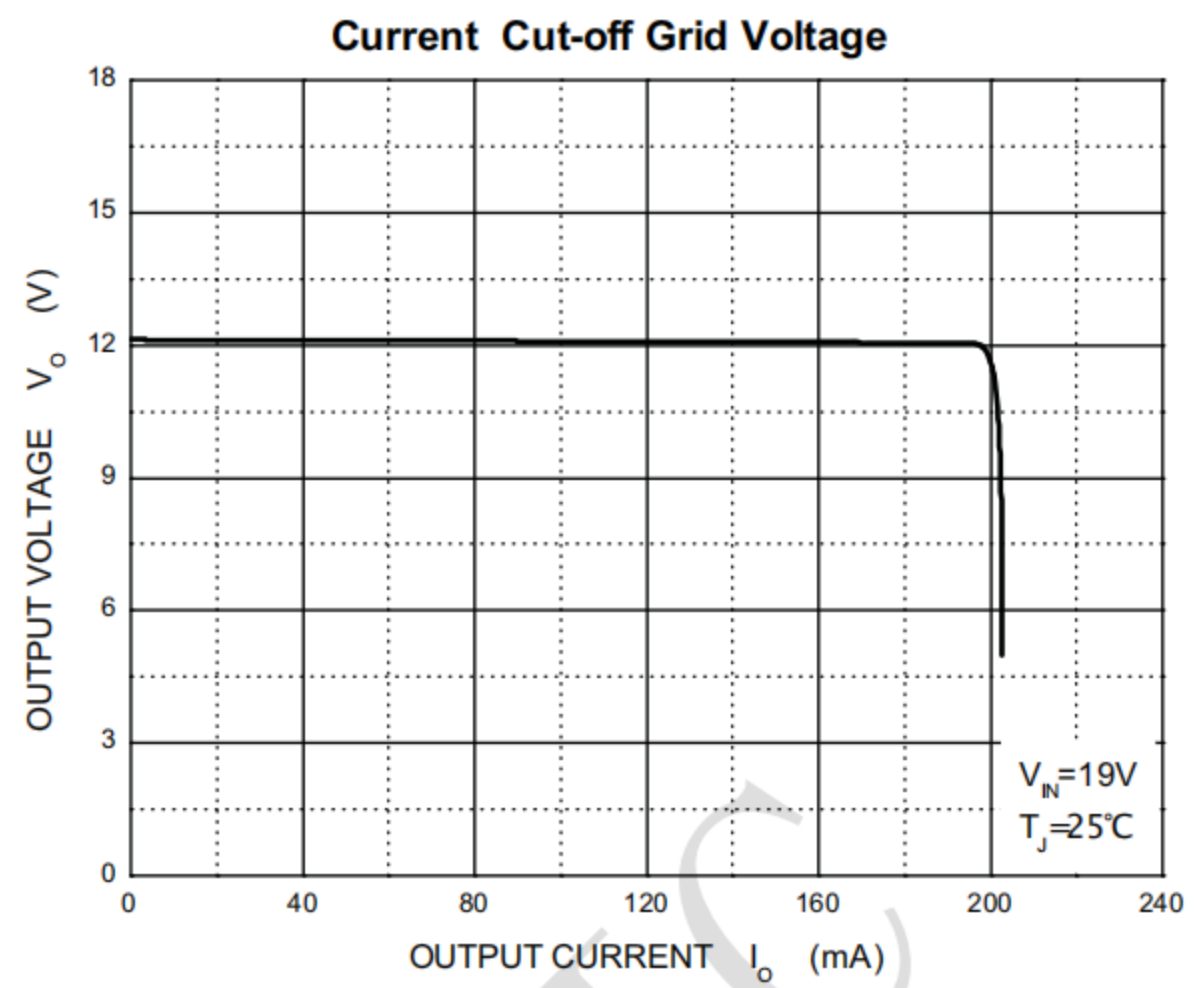
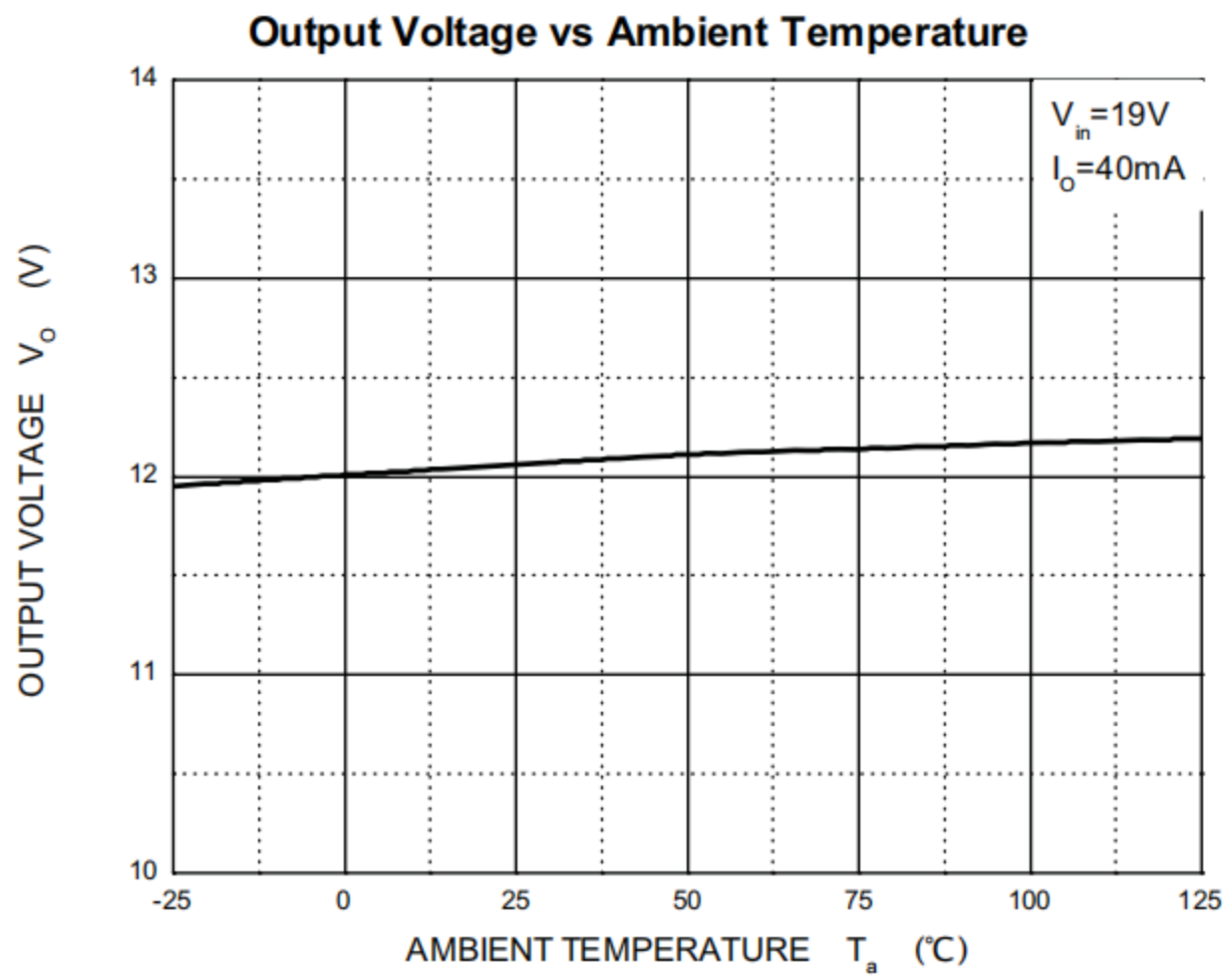

Package information

www.sot23.com.tw

SOT89-3

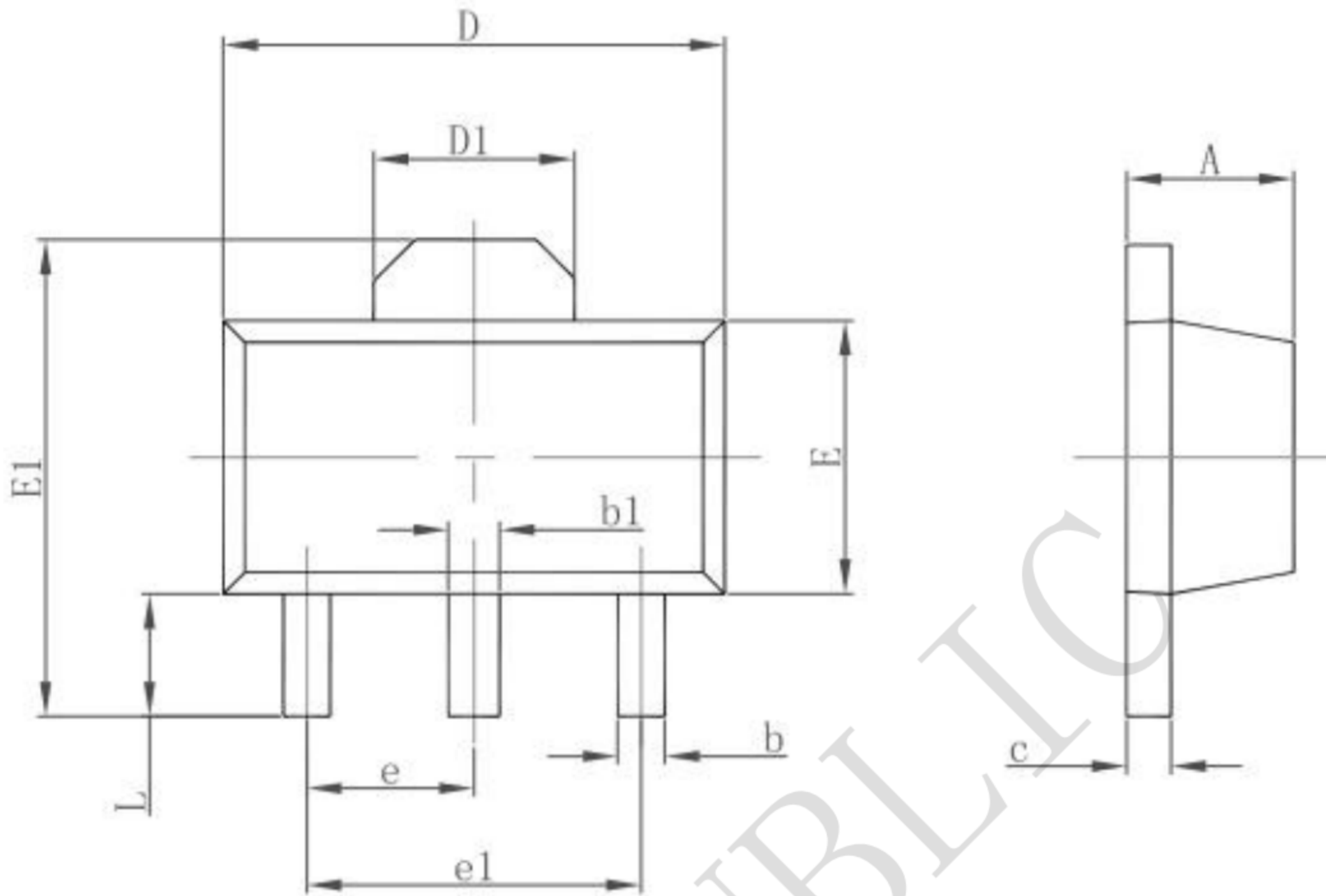

Symbol	Dimensions In Millimeters		Dimensions In Inches	
	Min.	Max.	Min.	Max.
A	1.400	1.600	0.055	0.063
b	0.320	0.520	0.013	0.020
b1	0.400	0.580	0.016	0.023
c	0.350	0.440	0.014	0.017
D	4.400	4.600	0.173	0.181
D1	1.550 REF.		0.061 REF.	
E	2.300	2.600	0.091	0.102
E1	3.940	4.250	0.155	0.167
e	1.500 TYP.		0.060 TYP.	
e1	3.000 TYP.		0.118 TYP.	
L	0.900	1.200	0.035	0.047

X-ON Electronics

Largest Supplier of Electrical and Electronic Components

Click to view similar products for [Linear Voltage Regulators](#) category:

Click to view products by [TECH PUBLIC](#) manufacturer:

Other Similar products are found below :

[LV5684PVD-XH](#) [MCDTSA6-2R](#) [L7815ACV-DG](#) [LV56801P-E](#) [UA7805CKC](#) [714954EB](#) [ZMR500QFTA](#) [BA033LBSG2-TR](#)
[NCV78M05ABDTRKG](#) [LV5680P-E](#) [L79M05T-E](#) [L78LR05D-MA-E](#) [NCV317MBTG](#) [NTE7227](#) [MP2018GZD-33-P](#) [MP2018GZD-5-P](#)
[LV5680NPVC-XH](#) [ZTS6538SE](#) [UA78L09CLP](#) [UA78L09CLPR](#) [CAT6221-PPTD-GT3](#) [MC78M09CDTRK](#) [NCV51190MNTAG](#)
[BL1118CS8TR1833](#) [BL8563CKETR18](#) [BL8077CKETR33](#) [BL9153-33CC3TR](#) [BL9161G-15BADRN](#) [BL9161G-28BADRN](#)
[BRCO7530MMC](#) [CJ7815B-TFN-ARG](#) [LM317C](#) [GM7333K](#) [GM7350K](#) [XC6206P332MR](#) [HT7533](#) [LM7912S/TR](#) [LT1764S/TR](#) [LM7805T](#)
[LM338T](#) [LM1117IMP-3.3/TR](#) [HT1117AM-3.3](#) [HT7550S](#) [AMS1117-3.3](#) [HT7150S](#) [78L12](#) [HT7550](#) [HT7533-1](#) [HXY6206I-2.5](#) [HT7133](#)