

Features

- High Accurate $\pm 2\%$
- Precision VCC Monitoring of +2.5V, +3V, +3.3V and +5V Supplies
- Power Supply Transient Immunity
- Guaranteed Reset Valid to $VCC=+1V$
- Fully Specified Over Temperature
- 2 μ A Supply Current
- Available in One Output Configuration: Open-Drain Active-Low $\overline{\text{RESET}}$ Output

Applications

- Battery-operated systems and controllers
- Intelligent instruments
- Critical μ P and μ C power monitoring
- Portable / Battery powered equipment
- Automotive

Pin Definition

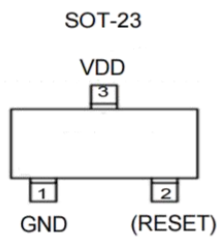

Ordering Information

TPAX803SS3

RESET VOLTAGE: L=4.63V

M=4.38V

T=3.08V

S=2.93V

R=2.63V

PIN CONFIGURATION

PIN	NAME	FUNCTION
1	GND	Ground
2	$\overline{\text{RESET}}$	$\overline{\text{RESET}}$ Output remains low while VCC is below the reset threshold, and for at least 140ms after VCC rises above the reset threshold.
3	VCC	+5V, +3.3V, +3V or +2.5V Supply Voltage .

Absolute Maximum Ratings

Symbol	Parameter	Value	UNIT
VCC	Supply Voltage	-0.3 to +6.0	V
	RESET	-0.3 to +6.0	V
ICC	Input Current, VCC	20	mA
IO	Output Current, RESET	20	mA
	Rate of Rise, VCC	100	V/ μ s
PD	Continuous Power Dissipation Derate 4mW/ $^{\circ}$ C above 70 $^{\circ}$ C	320	mW
TA	Operating Temperature Range	-40 to +105	$^{\circ}$ C
TSTG	Storage Temperature Range	-65 to +150	$^{\circ}$ C
R $^{\theta}$ JC	Thermal Resistance from Junction to Case	110	$^{\circ}$ C/W
R $^{\theta}$ JA	Thermal Resistance from Junction to Ambient	250	$^{\circ}$ C/W

TYPICAL APPLICATION CIRCUIT

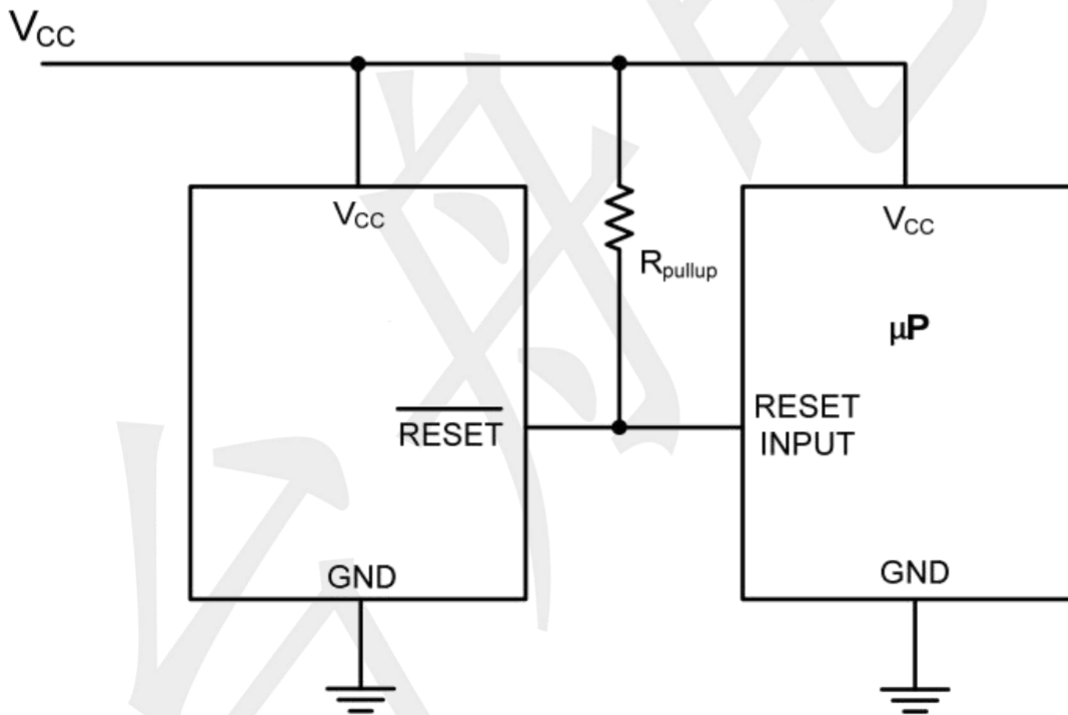

Electrical Characteristics

(VCC=5V for L/M/J versions, VCC=3.3V for T/S versions, VCC=3V for R version, and VCC=2.5V for Z version, TA=-40°C to +85°C, unless otherwise noted. Typical values are at TA=+25°C.)

Symbol	Parameter	Conditions	MIN	Typ	MAX	UNIT	
VCC	Supply Voltage Range	TA=0°C to +70°C	1.0	--	5.5	V	
ICC	Supply Current		--	2.0	--	uA	
VTH	Reset Threshold	L Version	TA=+25°C	4.56	4.63	4.70	V
			TA=-40°C to +85°C	4.50	--	4.75	
		M Version	TA=+25°C	4.31	4.38	4.45	
			TA=-40°C to +85°C	4.25	--	4.50	
		J Version	TA=+25°C	3.93	4.00	4.06	
			TA=-40°C to +85°C	3.89	--	4.10	
		T Version	TA=+25°C	3.04	3.08	3.11	
			TA=-40°C to +85°C	3.00	--	3.15	
		S Version	TA=+25°C	2.89	2.93	3.96	
			TA=-40°C to +85°C	2.85	--	3.00	
R Version	TA=+25°C	2.59	2.63	2.66			
	TA=-40°C to +85°C	2.55	--	2.70			
Z Version	TA=+25°C	2.28	2.32	2.35			
	TA=-40°C to +85°C	2.25	--	2.38			
	Reset Threshold Tempco		--	150	--	ppm/°C	
	VCC to Reset Delay	VCC=VTH to (VTH-100mV)	--	10	--	μS	
TRP	Reset Active Timeout Period		140	240	560	mS	
VOL	RESET Output Voltage Low	VCC=VTH min, ISINK=1.2mA, T_/S_/R_/Z_	--	--	0.3	V	
		VCC=VTH min, ISINK=3.2mA, T_/S_/R_/Z_	--	--	0.4		
		VCC>1.0V, ISINK=50μA	--	--	0.3		
	RESET Open-Drain Output Leakage Current	VCC>VTH, RESET Deasserted	--	--	1	μA	

Typical Operating Characteristics($T_A=+25^{\circ}\text{C}$, unless otherwise noted.)

Supply Current vs. Temperature

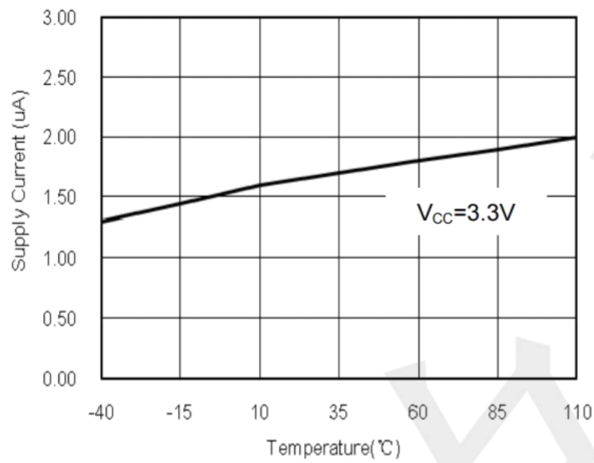

Power-Down RESET Delay vs. Temperature

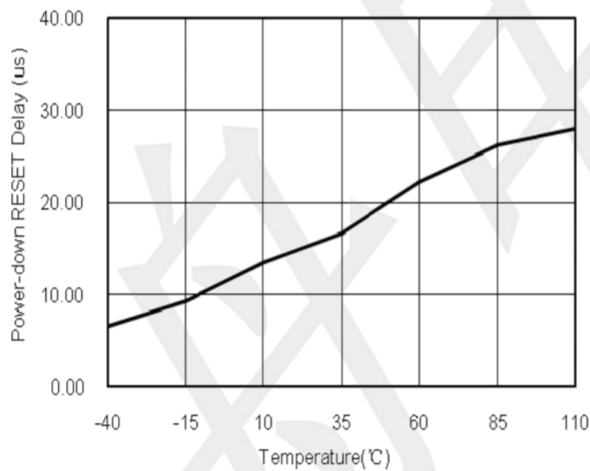

Power-Up RESET Timeout vs. Temperature

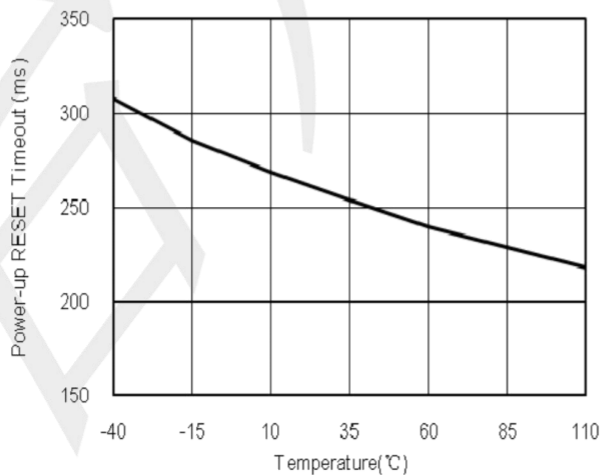

Package information SOT-23

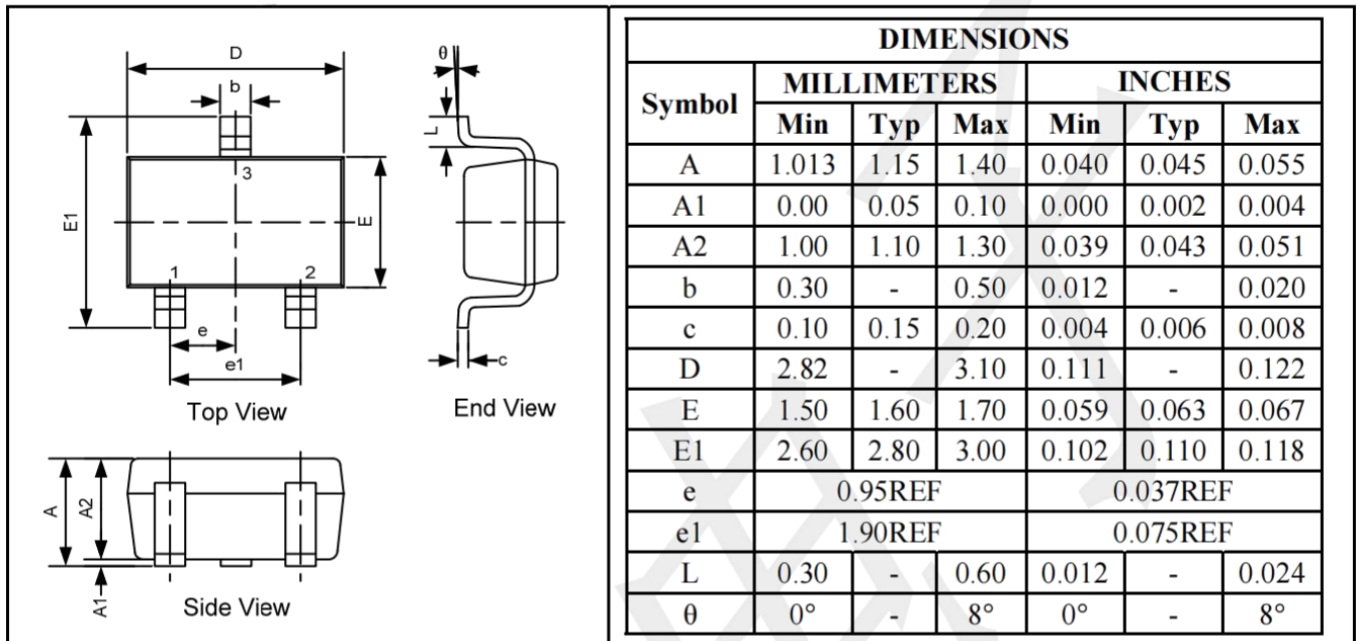

Suggested Pad Layout

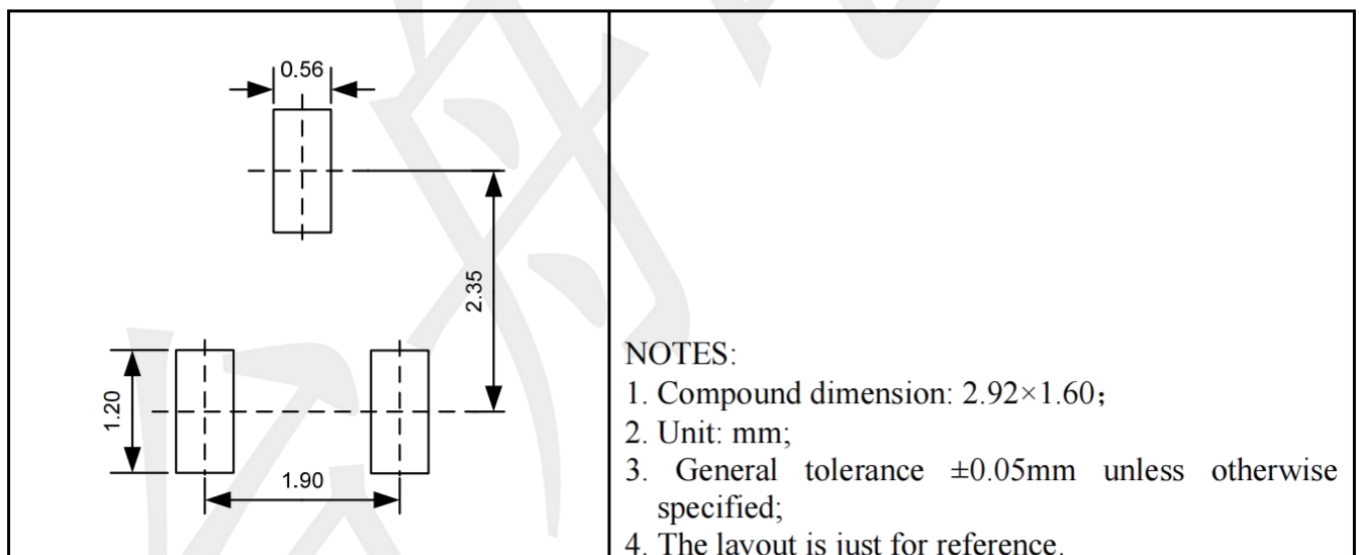

X-ON Electronics

Largest Supplier of Electrical and Electronic Components

Click to view similar products for [TECH PUBLIC](#) manufacturer:

Other Similar products are found below :

[TPG113S6](#) [TP9001-30S5](#) [PESD5V0X1BT-P](#) [TP132C18D4-1](#) [TPE0552R3](#) [TPD5V0L2B3T-7](#) [TPE24U2S3](#) [TPE1272BS3](#) [ESD9N5BU-TP](#)
[TPESD3394P](#) [TPESDBL5V0E2](#) [FDG6308P-P](#) [TPE05RUL](#) [TPM4401NEC6](#) [TPESD24BC3](#) [TPVESD05A1B-HD1](#) [TPPRTR5V0U2D](#)
[TPM2013PLS8-1](#) [PESD9M5.0ST5G](#) [TPM3134KW](#) [TPM2008P3](#) [PESD3V3S1BA](#) [TPESD12BS3](#) [TPESD0201G24V](#) [TPM60130ND56](#)
[NUP4106DR2G](#) [TPSL15T1G](#) [SRDA3.3-4DR2G](#) [TPSP0502BAJTG](#) [TPRCLAMP0524S](#) [TPESD12VU1UT](#) [RClamp0554S](#) [DLP05LC](#)
[LCDA24C-1](#) [TP5322K1-G](#) [TPESD7272LT1G](#) [TPESD03H2ZA](#) [BSP225](#) [FQT4N20LTF-TP](#) [AZ5123-01H-P](#) [TPZVP4525GTA](#)
[TPFQT2P25TF](#) [TP162C18S5](#) [TPESDA25-4BP6](#) [TPM30V6NS6-4](#) [BSP317P](#) [TPM2505PY3](#) [TPSP3003-02XTG](#) [BSR92P](#) [TPZVP4525E6TA](#)