

### Product Summary

● **N-Channel**

- $V_{DS} = 30V, I_D = 4A$   
 $R_{DS(ON)} 30m\Omega @ V_{GS}=10V (Typ)$   
 $R_{DS(ON)} 50m\Omega @ V_{GS}=-4.5V (Typ)$

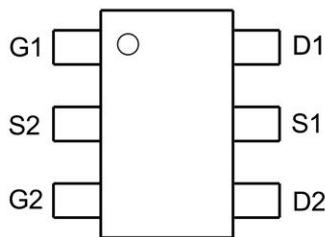
● **P-Channel**

- $V_{DS} = -30V, I_D = -3.0A$   
 $R_{DS(ON)} 45m\Omega @ V_{GS}=-10V (Typ)$   
 $R_{DS(ON)} 70m\Omega @ V_{GS}=-4.5V (Typ)$

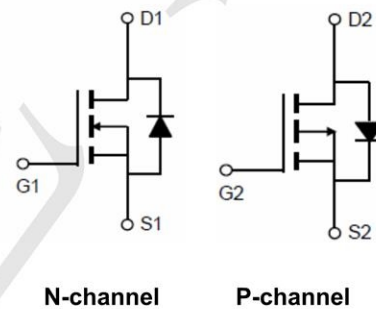
### Application

- DC-DC Converters.
- Load Switch.
- Power Management.

### Package and Pin Configuration



### Circuit diagram



N-channel

P-channel

Marking:



### Absolute Maximum Ratings ( $T_A=25^\circ C$ unless otherwise noted)

Parameter	Symbol	N-Channel	P-Channel	Unit	
Drain-Source Voltage	$V_{DS}$	30	-30	V	
Gate-Source Voltage	$V_{GS}$	$\pm 20$	$\pm 20$	V	
Continuous Drain Current	$I_D$	$T_A=25^\circ C$	4.0	-3.0	A
		$T_A=70^\circ C$	3	-2.1	
Pulsed Drain Current (Note 1)	$I_{DM}$	20	-15	A	
Maximum Power Dissipation	$P_D$	1.2		W	
Operating Junction and Storage Temperature Range	$T_J, T_{STG}$	-55 To 150	-55 To 150	$^\circ C$	

### Thermal Characteristic

Thermal Resistance, Junction-to-Ambient (Note 2)	$R_{\theta JA}$	N-Ch	104	$^\circ C/W$
Thermal Resistance, Junction-to-Ambient (Note 2)	$R_{\theta JA}$	P-Ch	104	$^\circ C/W$

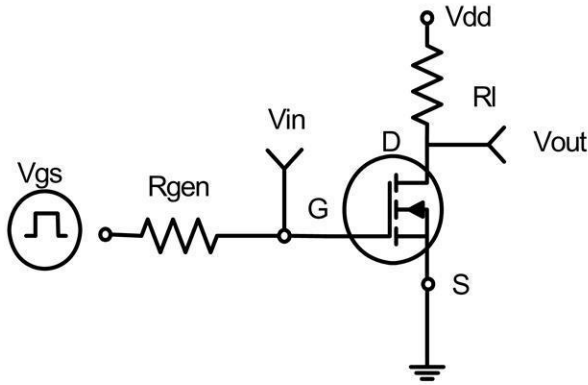
**N-CH Electrical Characteristics (T<sub>A</sub>=25°C unless otherwise noted)**

Parameter	Symbol	Condition	Min	Typ	Max	Unit
<b>Off Characteristics</b>						
Drain-Source Breakdown Voltage	BV <sub>DSS</sub>	V <sub>GS</sub> =0V, I <sub>D</sub> =250μA	30		-	V
Zero Gate Voltage Drain Current	I <sub>DSS</sub>	V <sub>DS</sub> =30V, V <sub>GS</sub> =0V	-	-	1	μA
Gate-Body Leakage Current	I <sub>GSS</sub>	V <sub>GS</sub> =±20V, V <sub>DS</sub> =0V	-	-	±100	nA
<b>On Characteristics</b> (Note 3)						
Gate Threshold Voltage	V <sub>GS(th)</sub>	V <sub>DS</sub> =V <sub>GS</sub> , I <sub>D</sub> =250μA	1.2	1.5	2.2	V
Drain-Source On-State Resistance	R <sub>DS(ON)</sub>	V <sub>GS</sub> =10V, I <sub>D</sub> =4A		30	48	mΩ
		V <sub>GS</sub> =4.5V, I <sub>D</sub> =2A		50	90	mΩ
Forward Transconductance	g <sub>FS</sub>	V <sub>DS</sub> =5V, I <sub>D</sub> =3.1A	-	4	-	S
<b>Dynamic Characteristics</b> (Note 4)						
Input Capacitance	C <sub>ISS</sub>	V <sub>DS</sub> =15V, V <sub>GS</sub> =0V, F=1.0MHz	-	210	-	PF
Output Capacitance	C <sub>OSS</sub>		-	35	-	PF
Reverse Transfer Capacitance	C <sub>rss</sub>		-	23	-	PF
<b>Switching Characteristics</b> (Note 4)						
Turn-on Delay Time	t <sub>d(on)</sub>	V <sub>DD</sub> =15V, R <sub>L</sub> =3Ω V <sub>GS</sub> =10V, R <sub>GEN</sub> =6Ω	-	4.5	-	nS
Turn-on Rise Time	t <sub>r</sub>		-	1.5	-	nS
Turn-Off Delay Time	t <sub>d(off)</sub>		-	18.5	-	nS
Turn-Off Fall Time	t <sub>f</sub>		-	15.5	-	nS
Total Gate Charge	Q <sub>g</sub>	V <sub>DS</sub> =15V, I <sub>D</sub> =3.5A, V <sub>GS</sub> =10V	-	5	-	nC
Gate-Source Charge	Q <sub>gs</sub>		-	0.55	-	nC
Gate-Drain Charge	Q <sub>gd</sub>		-	1	-	nC
<b>Drain-Source Diode Characteristics</b>						
Diode Forward Voltage (Note 3)	V <sub>SD</sub>	V <sub>GS</sub> =0V, I <sub>S</sub> =3.5A	-	0.8	1.2	V
Diode Forward Current (Note 2)	I <sub>S</sub>		-	-	4	A

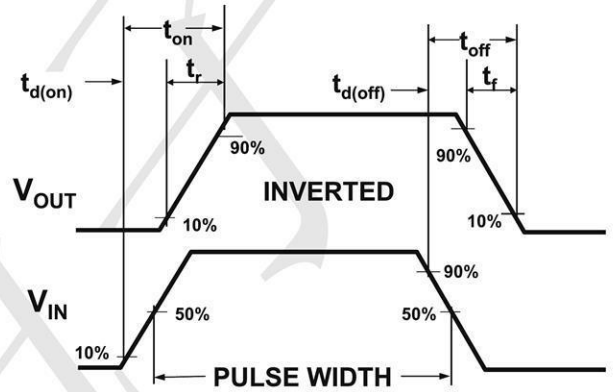
**P-CH Electrical Characteristics (T<sub>A</sub>=25°C unless otherwise noted)**

Parameter	Symbol	Condition	Min	Typ	Max	Unit
<b>Off Characteristics</b>						
Drain-Source Breakdown Voltage	BV <sub>DSS</sub>	V <sub>GS</sub> =0V, I <sub>D</sub> =-250μA	-30	-33	-	V
Zero Gate Voltage Drain Current	I <sub>DSS</sub>	V <sub>DS</sub> =-30V, V <sub>GS</sub> =0V	-	-	-1	μA
Gate-Body Leakage Current	I <sub>GSS</sub>	V <sub>GS</sub> =±20V, V <sub>DS</sub> =0V	-	-	±100	nA
<b>On Characteristics</b> (Note 3)						
Gate Threshold Voltage	V <sub>GS(th)</sub>	V <sub>DS</sub> =V <sub>GS</sub> , I <sub>D</sub> =-250μA	-1	-1.6	-2.5	V
Drain-Source On-State Resistance	R <sub>DS(on)</sub>	V <sub>GS</sub> =-10V, I <sub>D</sub> =-2.7A	-	45	65	mΩ
		V <sub>GS</sub> =-4.5V, I <sub>D</sub> =-2A	-	85	100	mΩ
Forward Transconductance	g <sub>FS</sub>	V <sub>DS</sub> =-10V, I <sub>D</sub> =-2.7A		2	-	S
<b>Dynamic Characteristics</b> (Note 4)						
Input Capacitance	C <sub>iss</sub>	V <sub>DS</sub> =-15V, V <sub>GS</sub> =0V, F=1.0MHz	-	199	-	PF
Output Capacitance	C <sub>oss</sub>		-	47	-	PF
Reverse Transfer Capacitance	C <sub>rss</sub>		-	28	-	PF
<b>Switching Characteristics</b> (Note 4)						
Turn-on Delay Time	t <sub>d(on)</sub>	V <sub>DD</sub> =-15V, R <sub>L</sub> =15Ω V <sub>GS</sub> =-10V, R <sub>GEN</sub> =6Ω	-	8	-	nS
Turn-on Rise Time	t <sub>r</sub>		-	5	-	nS
Turn-Off Delay Time	t <sub>d(off)</sub>		-	12	-	nS
Turn-Off Fall Time	t <sub>f</sub>		-	4	-	nS
Total Gate Charge	Q <sub>g</sub>	V <sub>DS</sub> =-15V, I <sub>D</sub> =-2.7A, V <sub>GS</sub> =-10V	-	5	-	nC
Gate-Source Charge	Q <sub>gs</sub>		-	0.7	-	nC
Gate-Drain Charge	Q <sub>gd</sub>		-	1.1	-	nC
<b>Drain-Source Diode Characteristics</b>						
Diode Forward Voltage (Note 3)	V <sub>SD</sub>	V <sub>GS</sub> =0V, I <sub>S</sub> =-2.7A	-	-	-1.2	V

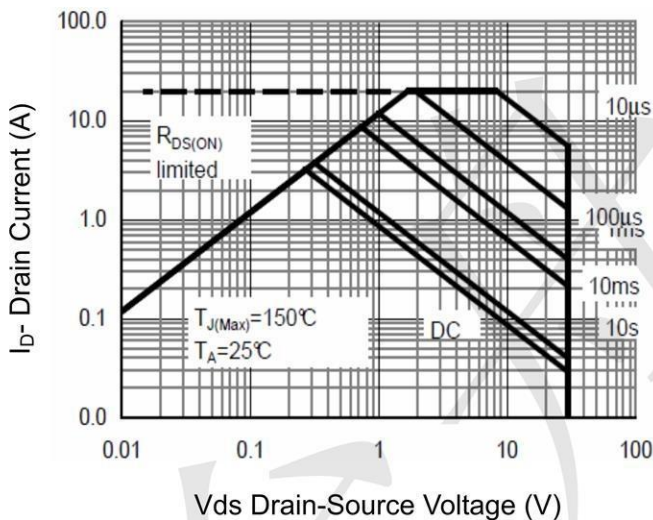
**N- Channel Typical Electrical and Thermal Characteristics**



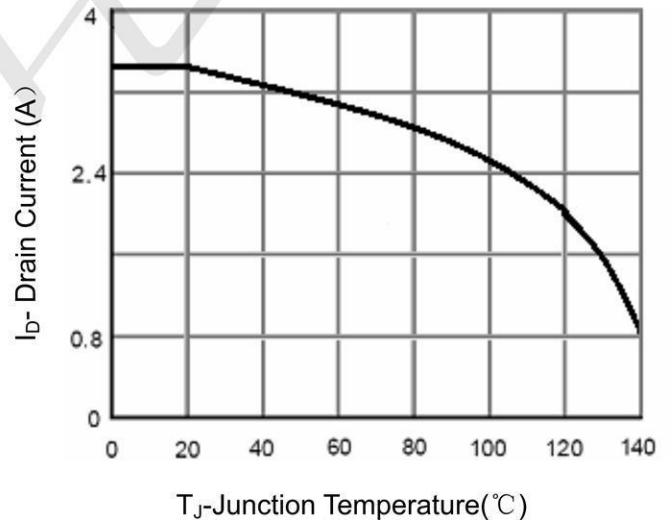
**Figure 1: Switching Test Circuit**



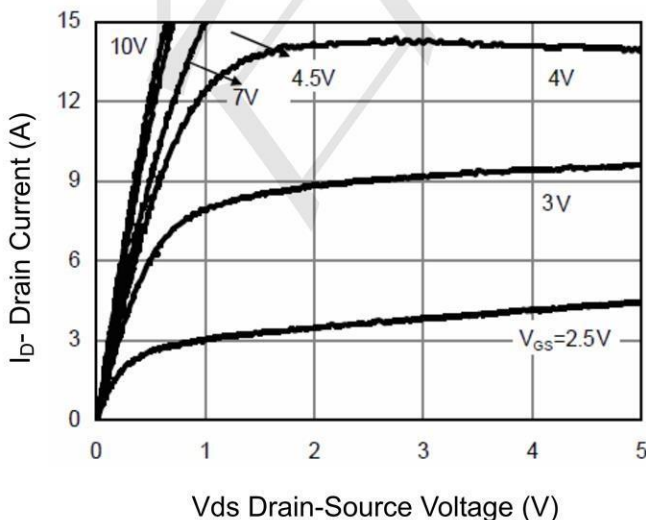
**Figure 2: Switching Waveforms**



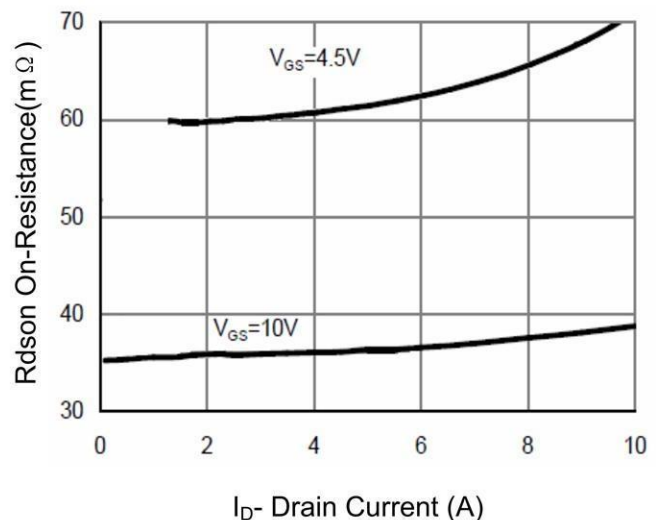
**Figure 3 Safe Operation Area**



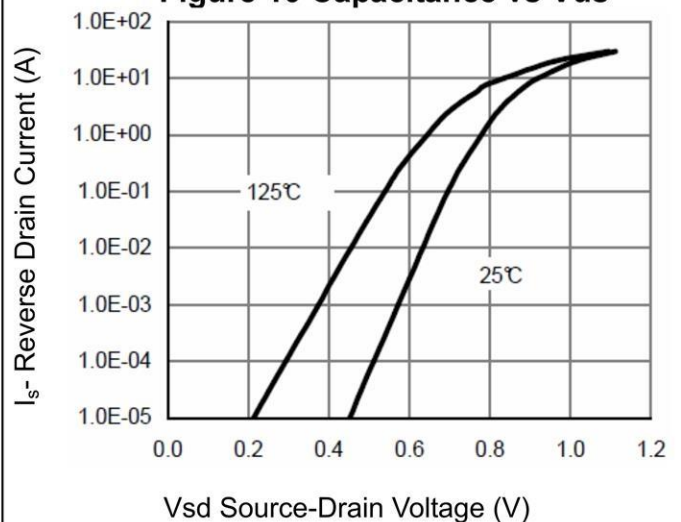
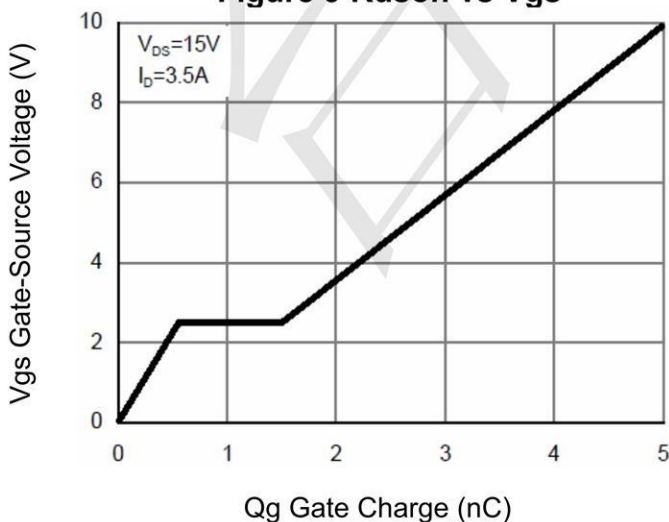
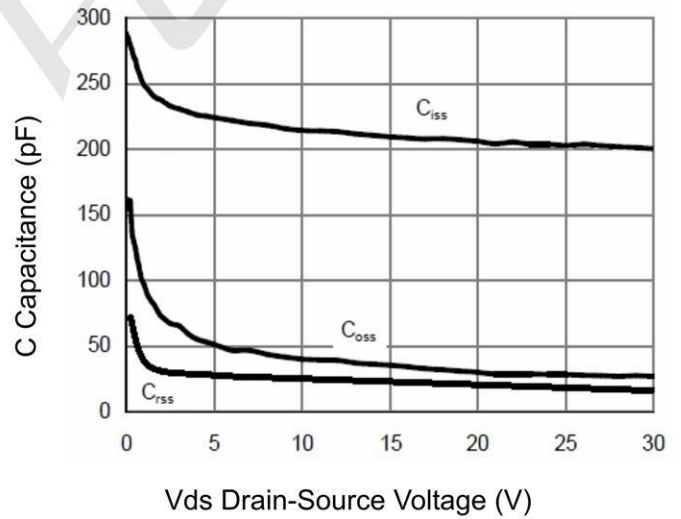
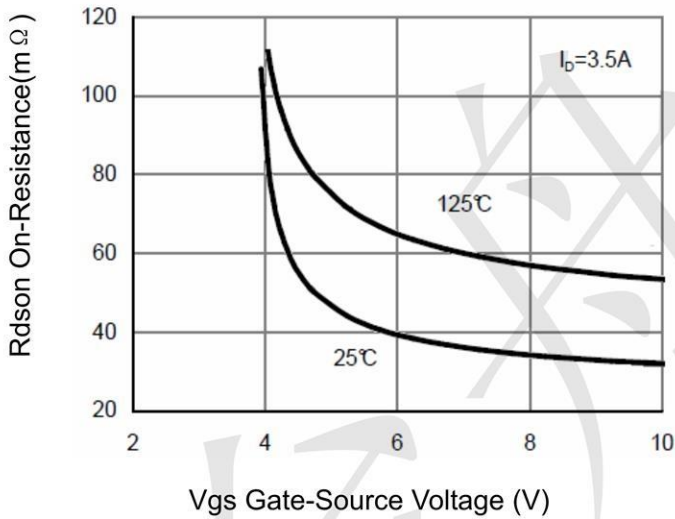
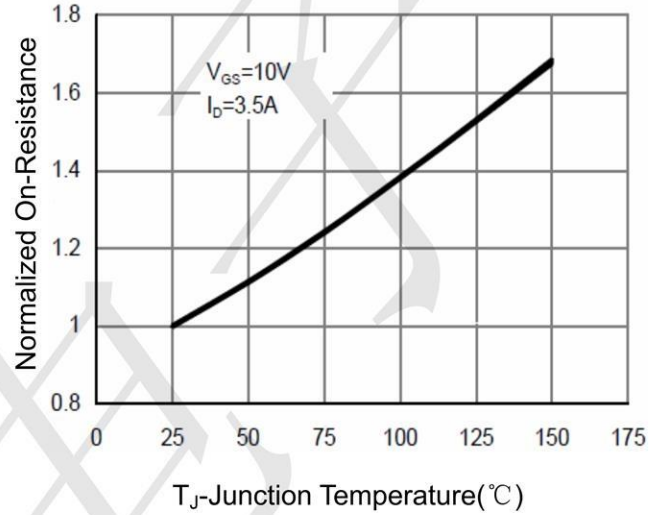
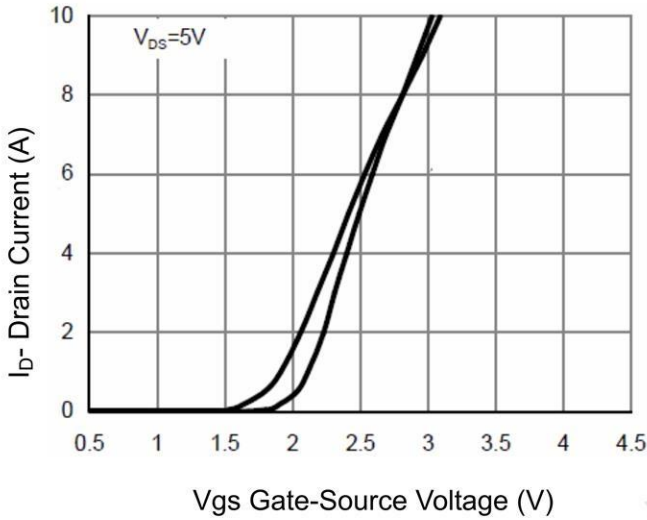
**Figure 4 Drain Current**

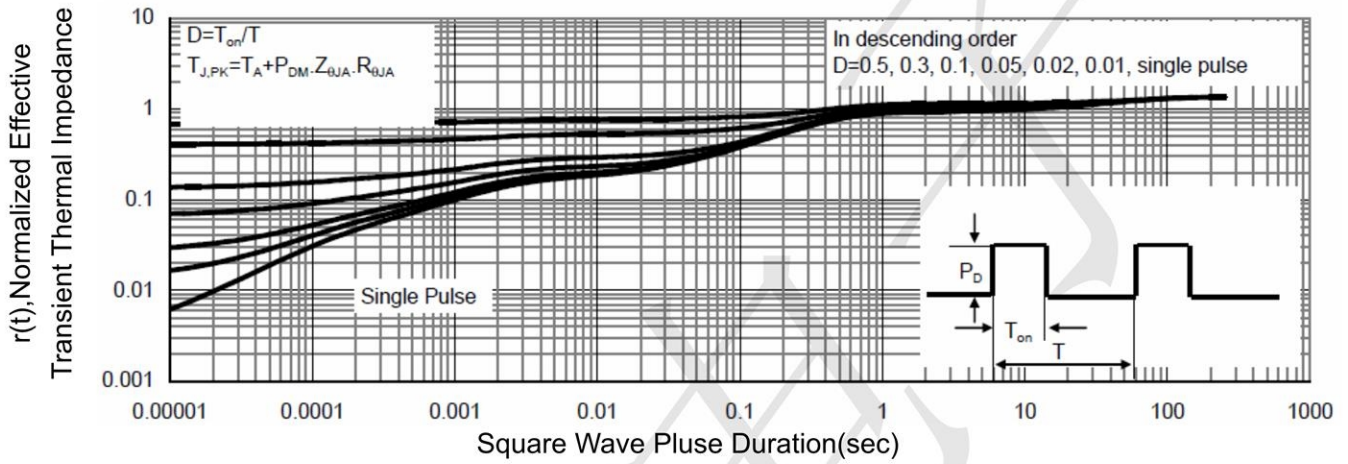


**Figure 5 Output Characteristics**



**Figure 6 Drain-Source On-Resistance**





**Figure 13 Normalized Maximum Transient Thermal Impedance**

P- Channel Typical Electrical and Thermal Characteristics

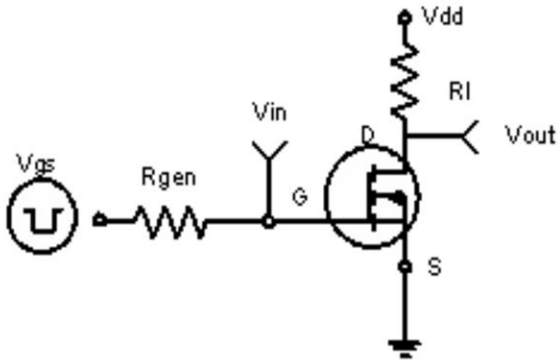


Figure 1: Switching Test Circuit

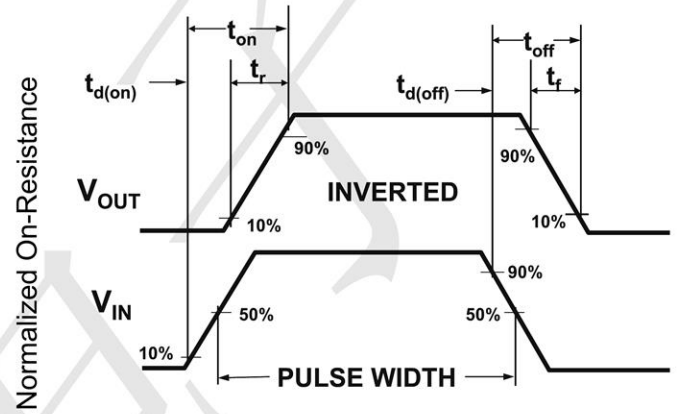


Figure 2: Switching Waveforms

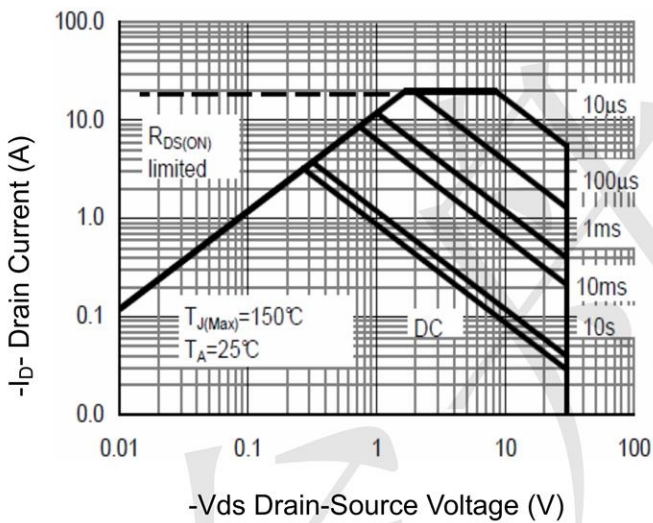


Figure 3 Safe Operation Area

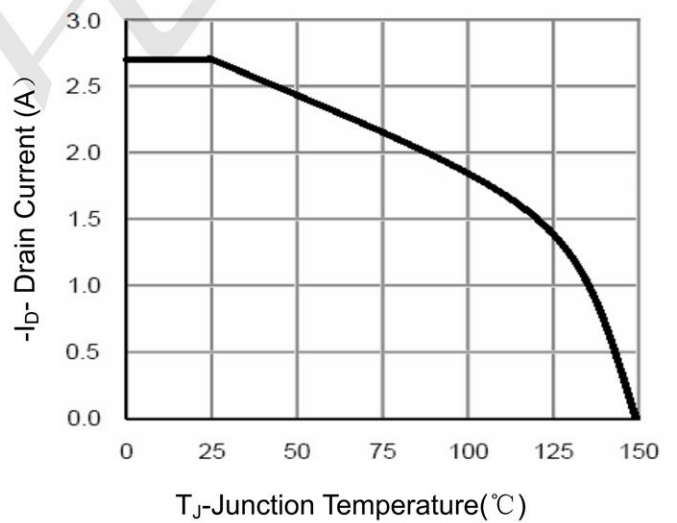


Figure 4 Drain Current

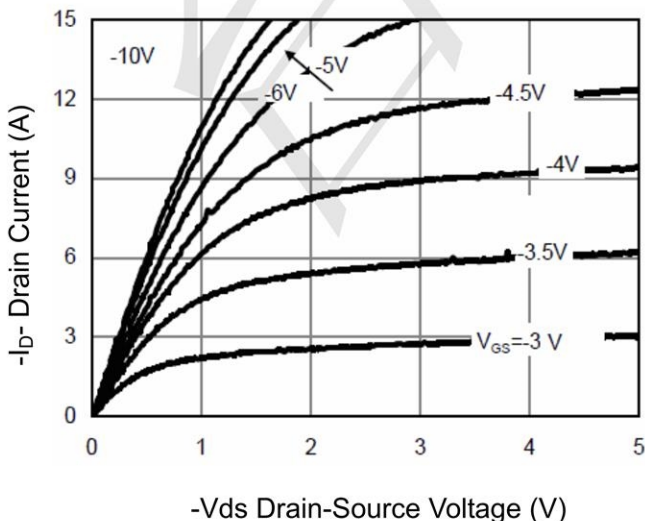


Figure 5 Output Characteristics

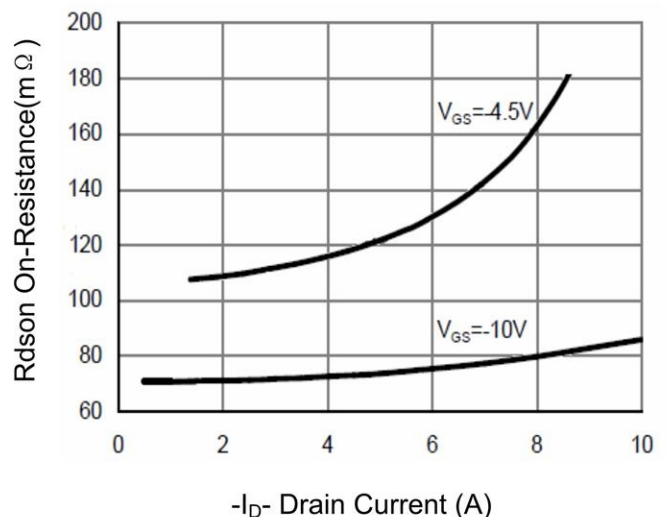


Figure 6 Drain-Source On-Resistance

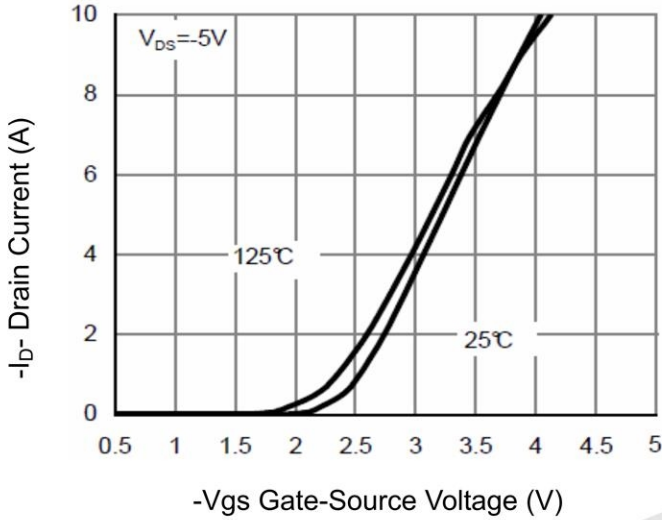


Figure 7 Transfer Characteristics

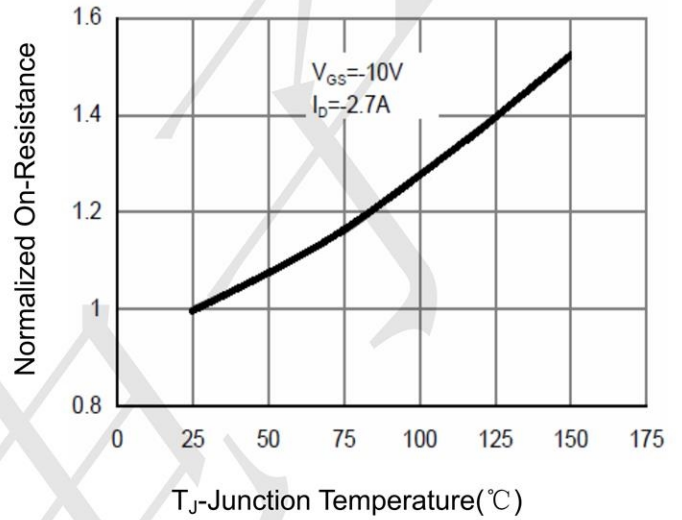


Figure 8 Drain-Source On-Resistance

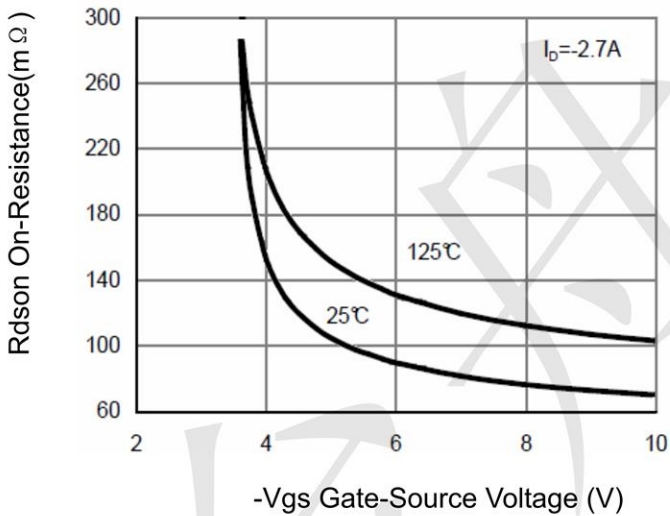


Figure 9 Rdson vs Vgs

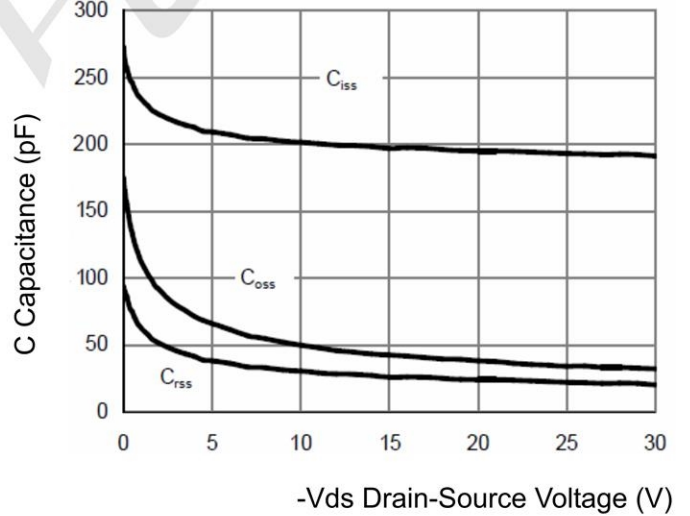


Figure 10 Capacitance vs Vds

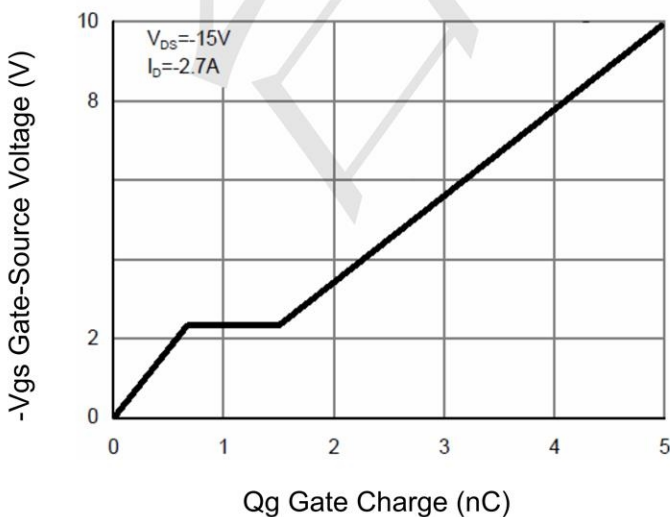


Figure 11 Gate Charge

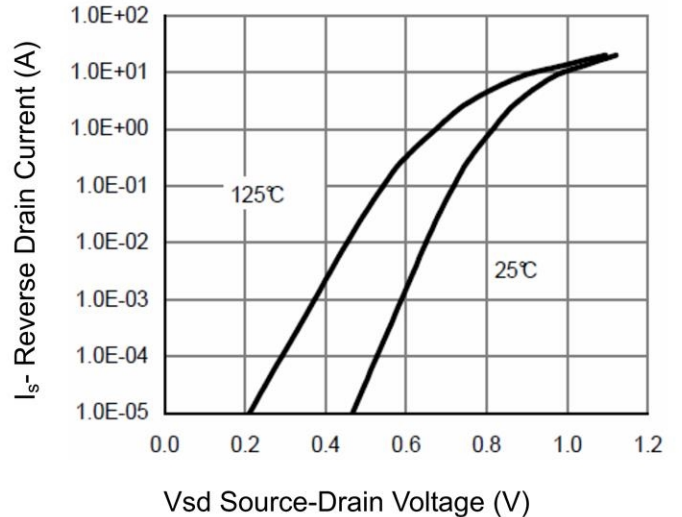
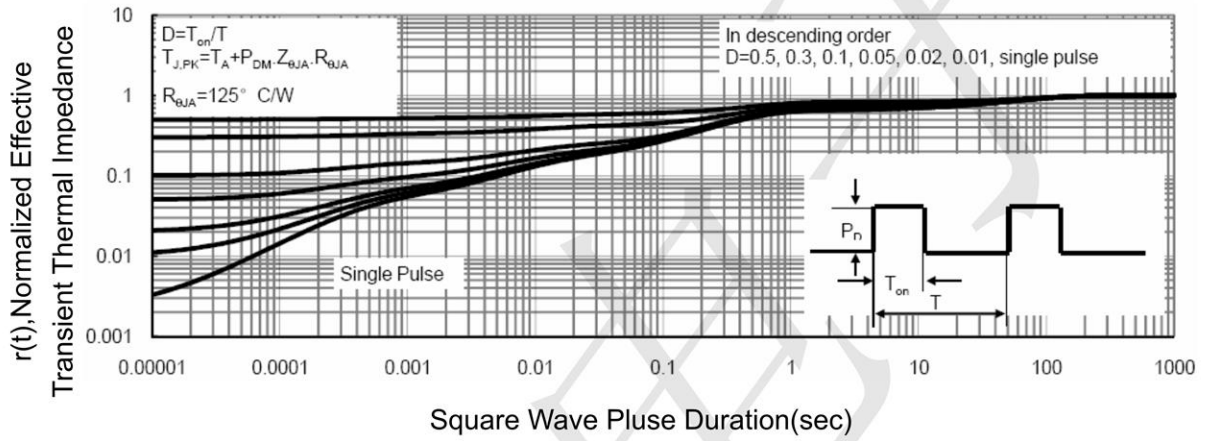


Figure 12 Source- Drain Diode Forward





**Figure 13 Normalized Maximum Transient Thermal Impedance**



**TECH PUBLIC**

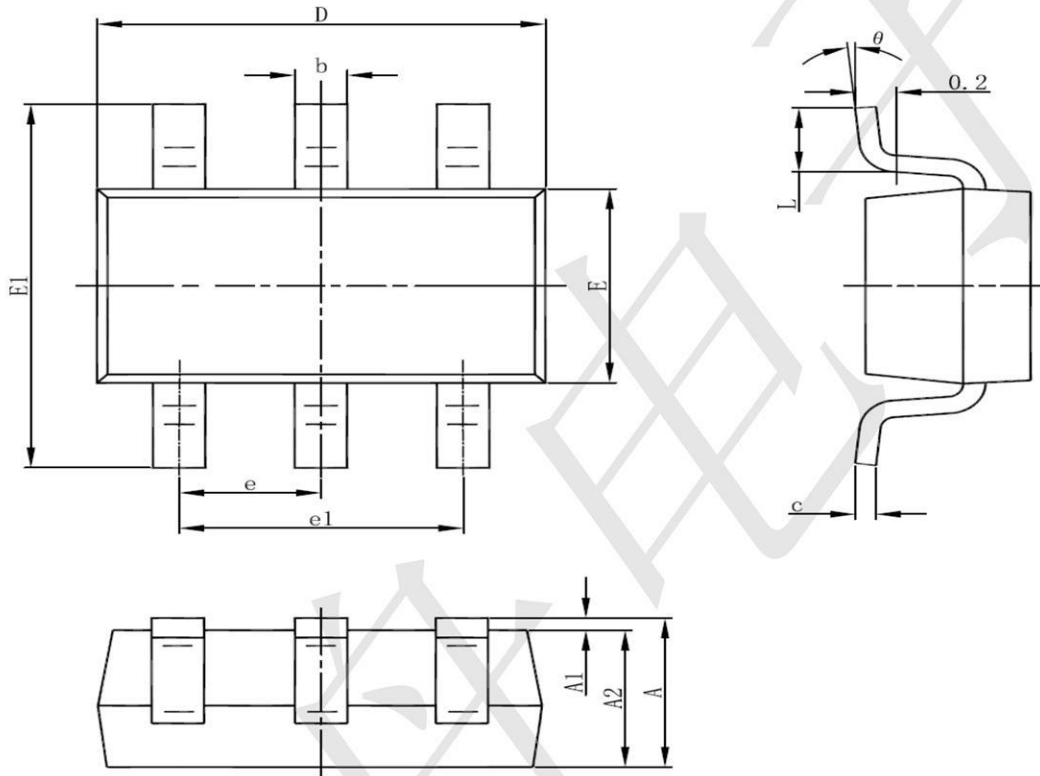
—台丹电子—

TPDMG6602SVT

N and P-Channel Enhancement Mode Power MOSFET

[www.sot23.com.tw](http://www.sot23.com.tw)

**SOT23-6 Package Information**



Symbol	Dimensions In Millimeters		Dimensions In Inches	
	Min	Max	Min	Max
A	1.050	1.250	0.041	0.049
A1	0.000	0.100	0.000	0.004
A2	1.050	1.150	0.041	0.045
b	0.300	0.500	0.012	0.020
c	0.100	0.200	0.004	0.008
D	2.820	3.020	0.111	0.119
E	1.500	1.700	0.059	0.067
E1	2.650	2.950	0.104	0.116
e	0.950(BSC)		0.037(BSC)	
e1	1.800	2.000	0.071	0.079
L	0.300	0.600	0.012	0.024
θ	0°	8°	0°	8°

## X-ON Electronics

Largest Supplier of Electrical and Electronic Components

*Click to view similar products for [MOSFET](#) category:*

*Click to view products by [TECH PUBLIC](#) manufacturer:*

Other Similar products are found below :

[614233C](#) [648584F](#) [MCH3443-TL-E](#) [MCH6422-TL-E](#) [NTNS3A92PZT5G](#) [IRFD120](#) [IRFF430](#) [JANTX2N5237](#) [2N7000](#) [AOD464](#)  
[2SK2267\(Q\)](#) [2SK2545\(Q,T\)](#) [405094E](#) [423220D](#) [MIC4420CM-TR](#) [VN1206L](#) [614234A](#) [715780A](#) [SSM6J414TU,LF\(T](#) [751625C](#)  
[IPS70R2K0CEAKMA1](#) [BSF024N03LT3 G](#) [PSMN4R2-30MLD](#) [TK31J60W5,S1VQ\(O](#) [2SK2614\(TE16L1,Q\)](#) [DMN1017UCP3-7](#)  
[EFC2J004NUZTDG](#) [FCAB21350L1](#) [P85W28HP2F-7071](#) [DMN1053UCP4-7](#) [NTE2384](#) [NTE2969](#) [NTE6400A](#) [DMC2700UDMQ-7](#)  
[DMN2080UCB4-7](#) [DMN61D9UWQ-13](#) [US6M2GTR](#) [DMN31D5UDJ-7](#) [SSM6P54TU,LF](#) [DMP22D4UFO-7B](#) [IPS60R3K4CEAKMA1](#)  
[DMN1006UCA6-7](#) [DMN16M9UCA6-7](#) [STF5N65M6](#) [IRF40H233XTMA1](#) [IPSA70R950CEAKMA1](#) [IPSA70R2K0CEAKMA1](#) [STU5N65M6](#)  
[C3M0021120D](#) [DMN6022SSD-13](#)