

## Features

- Ultra-Low capacitance:0.05pF(typ.)
- Low leakage current(<10nA)
- Fast response time(<1ns)
- Bi-directional,single line protection
- IEC 61000-4-2 (ESD Air): 15kV  
IEC 61000-4-2 (ESD Contact): 8kV

## Mechanical Characteristics

- USB 3.0/3.1
- HDMI 1.3/1.4/2.0
- RF Antenna
- SATA and eSATA Interface

## Applications

- Smart Phone/Mobile Internet Device
- Laptop/Desktop Computer
- Bi-directional, single line protection
- Antennas (Cell Phones, GPS...)
- High Speed Ethernet
- USB 3.0 and USB 3.1

## Ordering Information

Part Number	Qty per Reel	Reel Size
TPESD0201G Series	15000	7"

## Dimensions and Pin Configuration

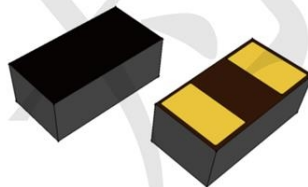

**Absolute Maximum Ratings** (Tamb=25°C unless otherwise specified)

Parameter	Symbol	Value	Unit
ESD per IEC 61000-4-2 (Air)	VESD	±15	kV
ESD per IEC 61000-4-2 (Contact)		±8	
Operating Temperature Range	TJ	-55 to +125	°C
Storage Temperature Range	Tstg	-40 to +85	°C

**Electrical Characteristics** (TA=25°C unless otherwise specified)

### TPESD0201G03V

Parameter	Symbol	Min	Typ	Max	Unit	Test Condition
Continuous Operating Voltage	V <sub>DC</sub>			3.3	V	
Trigger Voltage	V <sub>T</sub>		450		V	IEC61000-4-2 8kV contact discharge
Clamping Voltage	V <sub>C</sub>		40		V	IEC61000-4-2 8kV contact discharge
Leakage Current	I <sub>L</sub>			10	nA	DC 3.3V shall be applied on component
Capacitance	C <sub>J</sub>		0.05		pF	Measured at 10MHz

### TPESD0201G05V

Parameter	Symbol	Min	Typ	Max	Unit	Test Condition
Continuous Operating Voltage	V <sub>DC</sub>			5	V	
Trigger Voltage	V <sub>T</sub>		450		V	IEC61000-4-2 8kV contact discharge
Clamping Voltage	V <sub>C</sub>		40		V	IEC61000-4-2 8kV contact discharge
Leakage Current	I <sub>L</sub>			10	nA	DC 5V shall be applied on component
Capacitance	C <sub>J</sub>		0.05		pF	Measured at 10MHz

## TPESD0201G08V

Parameter	Symbol	Min	Typ	Max	Unit	Test Condition
Continuous Operating Voltage	$V_{DC}$			8	V	
Trigger Voltage	$V_T$		450		V	IEC61000-4-2 8kV contact discharge
Clamping Voltage	$V_C$		40		V	IEC61000-4-2 8kV contact discharge
Leakage Current	$I_L$			10	nA	DC 8V shall be applied on component
Capacitance	$C_J$		0.05		pF	Measured at 10MHz

## TPESD0201G12V

Parameter	Symbol	Min	Typ	Max	Unit	Test Condition
Continuous Operating Voltage	$V_{DC}$			12	V	
Trigger Voltage	$V_T$		450		V	IEC61000-4-2 8kV contact discharge
Clamping Voltage	$V_C$		40		V	IEC61000-4-2 8kV contact discharge
Leakage Current	$I_L$			10	nA	DC 12V shall be applied on component
Capacitance	$C_J$		0.05		pF	Measured at 10MHz

## TPESD0201G15V

Parameter	Symbol	Min	Typ	Max	Unit	Test Condition
Continuous Operating Voltage	$V_{DC}$			15	V	
Trigger Voltage	$V_T$		450		V	IEC61000-4-2 8kV contact discharge
Clamping Voltage	$V_C$		40		V	IEC61000-4-2 8kV contact discharge
Leakage Current	$I_L$			10	nA	DC 15 V shall be applied on component
Capacitance	$C_J$		0.05		pF	Measured at 10MHz

## TPESD0201G24V

Parameter	Symbol	Min	Typ	Max	Unit	Test Condition
Continuous Operating Voltage	$V_{DC}$			24	V	
Trigger Voltage	$V_T$		450		V	IEC61000-4-2 8kV contact discharge
Clamping Voltage	$V_C$		40		V	IEC61000-4-2 8kV contact discharge
Leakage Current	$I_L$			10	nA	DC 24V shall be applied on component
Capacitance	$C_J$		0.05		pF	Measured at 10MHz

## TPESD0201G36V

Parameter	Symbol	Min	Typ	Max	Unit	Test Condition
Continuous Operating Voltage	$V_{DC}$			36	V	
Trigger Voltage	$V_T$		450		V	IEC61000-4-2 8kV contact discharge
Clamping Voltage	$V_C$		40		V	IEC61000-4-2 8kV contact discharge
Leakage Current	$I_L$			10	nA	DC 36V shall be applied on component
Capacitance	$C_J$		0.05		pF	Measured at 10MHz

**PROTECTION PRODUCTS**  
Typical characteristics

**HDMI Mask at 3.4 Gbps**

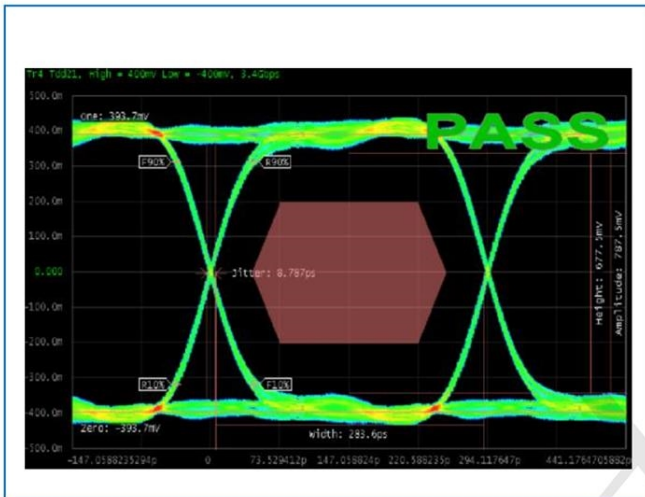

**USB3.0 Mask at 5.0 Gbps**

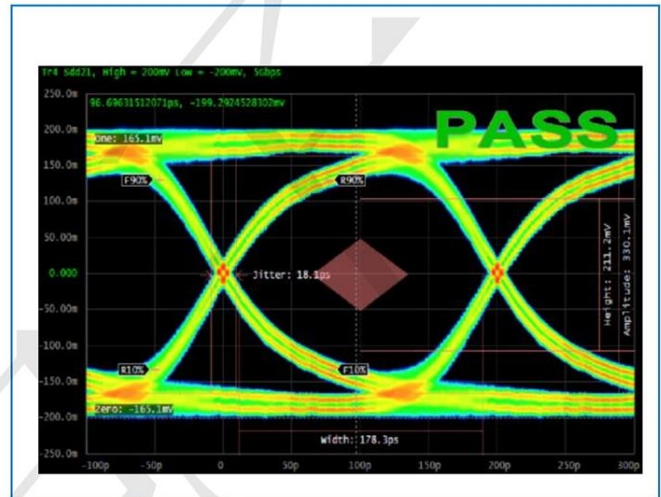

### ESD Protection for Signal Line

The TPESD0201G is designed for the protection of one bidirectional data line from ESD damage.

- Place the TPESD0201G as close to the input terminal or connector as possible.
- Minimize the path length between the TPESD0201G and the protected signal line.
- Use ground planes whenever possible.

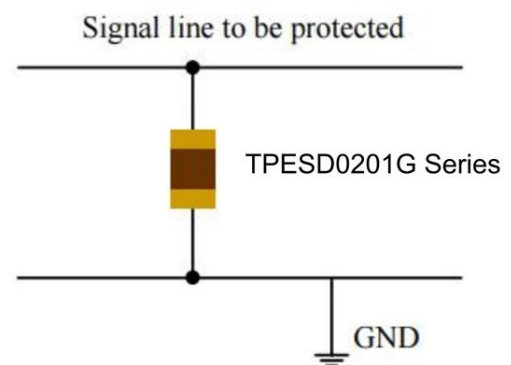
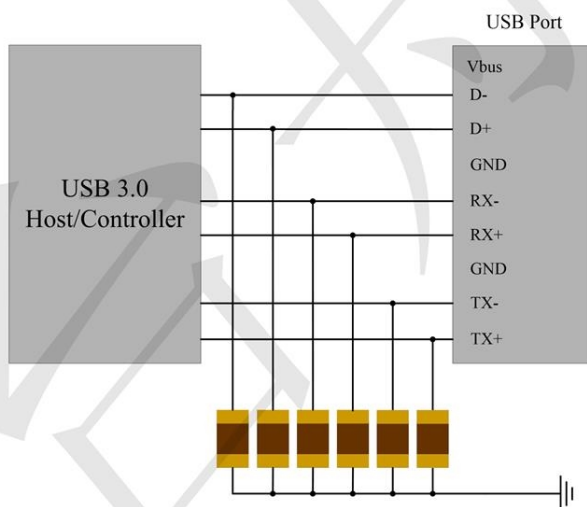

**Package Dimension**

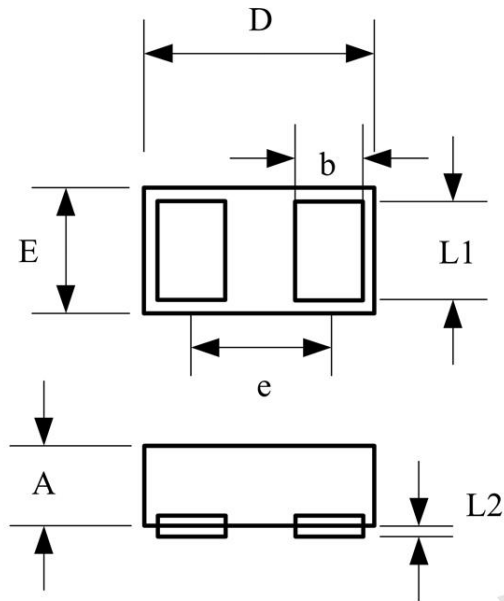

**Recommended Solder Pad Footprint**

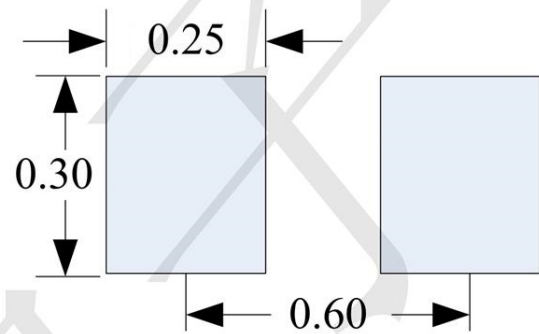

**\*Sizes in mm**

Notes:

This solder pad layout is for reference purposes only.

Dimension	Unit: Millimeters	
	Min.	Max.
A	0.25	0.40
b	0.15	0.20
D	0.50	0.70
E	0.25	0.35
e	0.45BSC	
L1	0.20	0.30
L2	0.00	0.05

## X-ON Electronics

Largest Supplier of Electrical and Electronic Components

*Click to view similar products for [ESD Suppressors / TVS Diodes](#) category:*

*Click to view products by [TECH PUBLIC](#) manufacturer:*

Other Similar products are found below :

[60KS200C](#) [D18V0L1B2LP-7B](#) [D5V0F4U5P5-7](#) [NTE4902](#) [P4KE27CA](#) [P6KE11CA](#) [P6KE39CA-TP](#) [P6KE8.2A](#) [JANTX1N6053A](#)  
[SA110CA](#) [SA60CA](#) [SA64CA](#) [SMBJ12CATR](#) [SMBJ33CATR](#) [SMBJ8.0A](#) [ESD105-B1-02EL E6327](#) [ESD112-B1-02EL E6327](#)  
[ESD5V0L1B02VH6327XTSA1](#) [ESD7451N2T5G](#) [19180-510](#) [CPDT-5V0USP-HF](#) [3.0SMCJ33CA-F](#) [3.0SMCJ36A-F](#) [HSPC16701B02TP](#)  
[JANTX1N6126A](#) [JANTX1N6465](#) [USB50805e3/TR7](#) [D3V3Q1B2DLP3-7](#) [D55V0M1B2WS-7](#) [DRTR5V0U4SL-7](#) [SCM1293A-04SO](#)  
[ESD200-B1-CSP0201 E6327](#) [SM12-7](#) [SM1605E3/TR13](#) [SMLJ45CA-TP](#) [CEN955 W/DATA](#) [82350120560](#) [VESD12A1A-HD1-GS08](#)  
[CPDUR5V0R-HF](#) [CPDQC5V0U-HF](#) [CPDQC5V0USP-HF](#) [CPDQC5V0-HF](#) [D1213A-01LP4-7B](#) [ESD101-B1-02EL E6327](#) [824500181](#)  
[MMAD1108/TR13](#) [5KP100A](#) [5KP15A](#) [5KP18A](#) [5KP48A](#)