

Features

- Ultra-Low capacitance (< 14pF)
- Low Clamping Voltage
- Working Voltage: 24V
- Low Leakage Current
- IEC 61000-4-2 (ESD) $\pm 20\text{kV}$ (air), $\pm 15\text{kV}$ (contact)
- IEC 61000-4-4 (EFT) 40A (5/50ns)

Mechanical Characteristics

- SOT-23 package
- Molding compound flammability rating: UL 94V-0
- Packaging: Tape and Reel per EIA 481
- RoHS Compliant

RoHS



Applications

- CAN Bus Protection
- Automotive Appllcatrons

Ordering Information

Part Number	Qty per Reel	Reel Size
TPESD1CAN	3000	7"

Dimensions and Pin Configuration

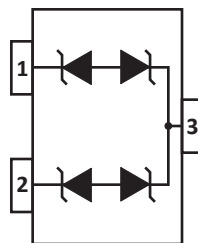

Absolute Maximum Ratings (T_{amb}=25°C unless otherwise specified)

Rating	Symbol	Value	Units
Peak Pulse Power (tp = 8/20μs)	P _{pk}	200	Watts
Peak Pulse Current (tp = 8/20μs)	I _{pp}	3	A
ESD per IEC 61000-4-2 (Air) ESD per IEC 61000-4-2 (Contact)	V _{ESD}	±20 ±15	kV
Operating Temperature	T _J	-55 to +125	°C
Storage Temperature	T _{STG}	-55 to +150	°C

Electrical Characteristics (TA=25°C unless otherwise specified)

PART NUMBER	RATED STAND-OFF VOLTAGE	MINIMUM BREAKDOWN VOLTAGE	MAXIMUM CLAMPING VOLTAGE (Fig. 2)	MAXIMUM LEAKAGE CURRENT	TYPICAL CAPACITANCE
V _{WM} VOLTS	V _{WM} VOLTS	@ 5mA V _(BR) VOLTS	@ I _p = 3A V _c VOLTS	@V _{WM} I _D μA	@0V, 1MHz C pF
TPESD1CAN	24	25.4	70	0.05	14

Typical Performance Characteristics ($T_A=25^\circ\text{C}$ unless otherwise Specified)

Fig1. 8/20 μs Pulse Waveform

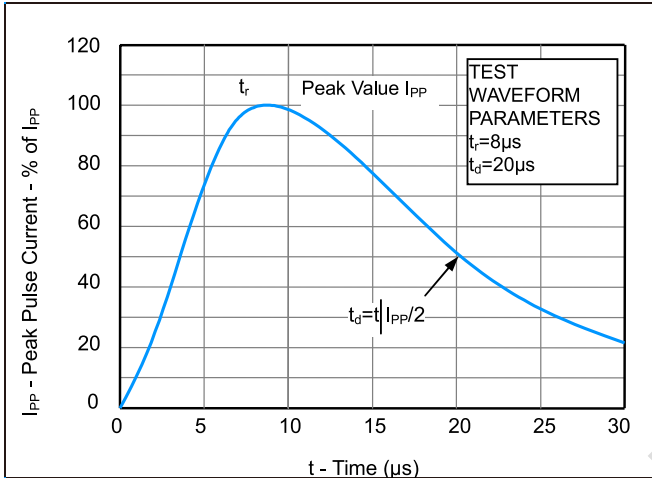

Fig2. ESD Pulse Waveform (according to IEC 61000-4-2)

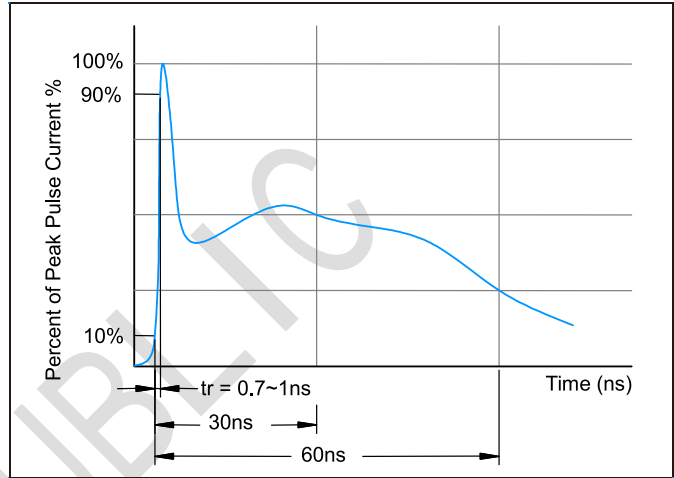

Fig3. Power Derating Curve

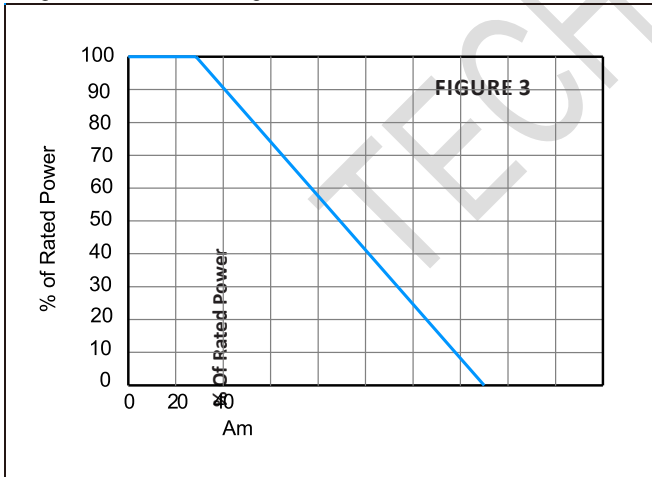
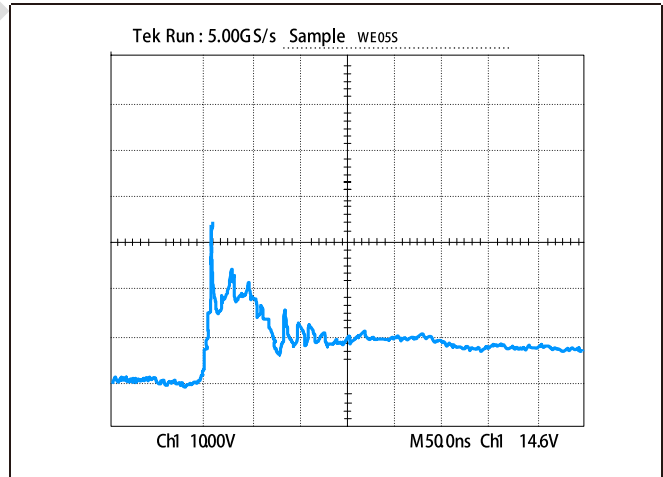
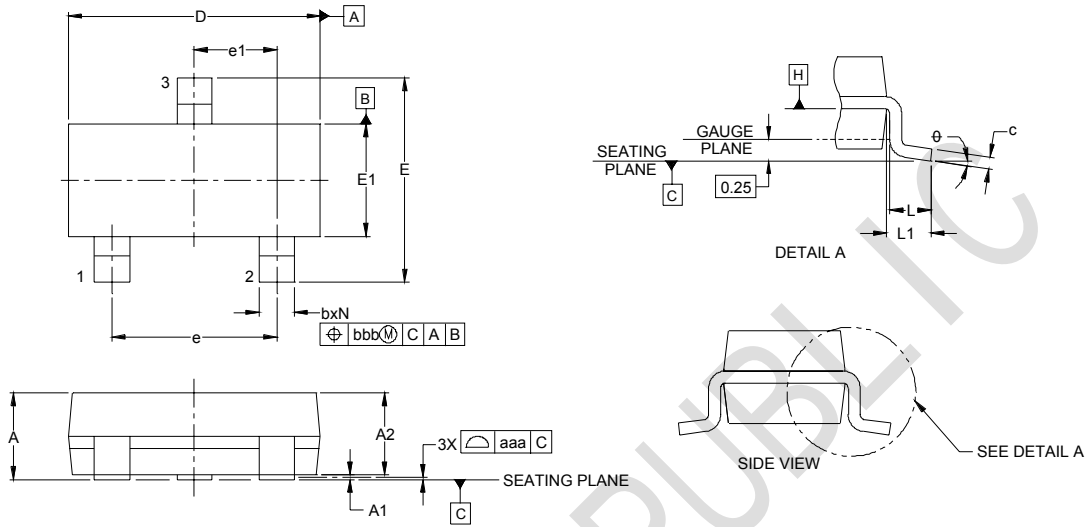

Figure 4: ESD Clamping (8kV Contact per IEC 61000-4-2)



Outline Drawing - SOT23



DIM	INCHES			MILLIMETERS		
	MIN	NOM	MAX	MIN	NOM	MAX
A	.035	-	.044	0.89	-	1.12
A1	.000	-	.004	0.01	-	0.10
A2	.035	.037	.040	0.88	0.95	1.02
b	.012	-	.020	0.30	-	0.51
c	.003	-	.007	0.08	-	0.18
D	.110	.114	.120	2.80	2.90	3.04
E	.082	.093	.104	2.10	2.37	2.64
E1	.047	.051	.055	1.20	1.30	1.40
e	.075	-	-	1.90	BSC	-
e1	.037	-	-	0.95	BSC	-
L	.015	.020	.024	0.40	0.50	0.60
L1	.022	-	-	(0.55)	-	-
N	3	-	-	3	-	-
phi	0°	-	8°	0°	-	8°
aaa	.004	-	-	0.10	-	-
bbb	.008	-	-	0.20	-	-

Land Pattern - SOT23

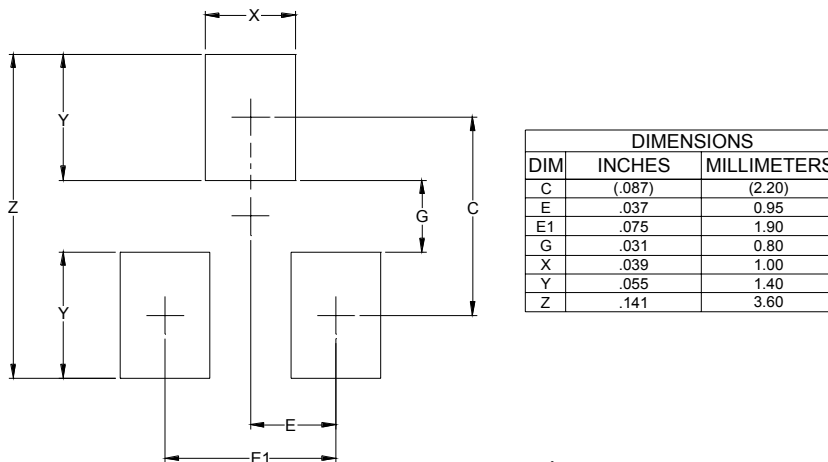

X-ON Electronics

Largest Supplier of Electrical and Electronic Components

Click to view similar products for [ESD Suppressors / TVS Diodes](#) category:

Click to view products by [TECH PUBLIC](#) manufacturer:

Other Similar products are found below :

[NTE4902](#) [P4SMAJ15A](#) [P4SMAJ26A](#) [SMAJ400CA-TP](#) [TGL34-47CA](#) [ESDAULC45-1BF4](#) [SM1605E3/TR13](#) [SMF20A-TP](#) [P4SMAJ12A](#)
[CPDUR24V-HF](#) [CPDQC5V0USP-HF](#) [CPDQC5V0-HF](#) [MPLAD30KP45CAE3](#) [MMBZ27VCLQ-7-F](#) [MMAD1108/TR13](#) [MPLAD30KP24A](#)
[ACPDQC5V0R-HF](#) [DFLT170A-7](#) [NTE4900](#) [NTE4926](#) [NTE4938](#) [SMF22A-TP](#) [SMF12A-TP](#) [SLVU2.8-TP](#) [SMLJ6.5CA-TP](#) [SMAJ6.5CA-](#)
[TP](#) [MMAD1108E3/TR13](#) [D5V0M1U2LP3-7](#) [SMAJ400A-TP](#) [AOZ8811DT-03](#) [AOZ8831DI-05](#) [AOZ8831DT-03](#) [SMAJ188CA](#) [3SMC33CA](#)
[BK](#) [CPDQC3V3C-HF](#) [CPDQC12VE-HF](#) [MPLAD30KP170CA](#) [82357120100](#) [5.0SMLJ15CA-TP](#) [5KP18A-TP](#) [P6KE8.2A-TP](#)
[MPLAD30KP43CAE3](#) [SMAJ43A-TP](#) [D5V0F6U8LP33-7](#) [TVS5501V10MUT5G](#) [5.0SMLJ24CA-TP](#) [SMAJ110CA-TP](#) [MPLAD15KP75CAE3](#)
[MMAD1103e3/TR13](#) [DFLT40AQ-7](#)