

## Features

- ◆ Ultra low capacitance: 0.1 pF typical (I/O to I/O)
- ◆ Ultra low leakage: nA level
- ◆ Low operating voltage: 3.3V
- ◆ Low clamping voltage
- ◆ Up to 4 data lines and one power line protects
- ◆ Complies with following standards:
  - IEC 61000-4-2 (ESD) immunity test
    - Air discharge: ±20kV
    - Contact discharge: ±15kV
  - IEC61000-4-4 (EFT) 40A (5/50ns)
  - IEC61000-4-5 (Lightning) : 6.5A(8/20µs)
- ◆ ROHS Compliant

## Mechanical Characteristics

- ◆ Package: DFN2510-10 (2.5×1.0×0.5mm)
- ◆ Ultra low leakage: nA level
- ◆ Case Material: "Green" Molding Compound.
- ◆ UL Flammability Classification Rating 94V-0
- ◆ Moisture Sensitivity: Level 3 per J-STD-020
- ◆ Terminal Connections: See Diagram Below

## Applications

- ◆ High Definition Multimedia Interface (HDMI)
- ◆ Digital Visual Interface (DVI)
- ◆ Unified Display Interface (UDI)
- ◆ MDDI Ports
- ◆ PCI Express
- ◆ Serial ATA

## Ordering Information

Part Number	Qty per Reel	Reel Size
TPESD3394P	3000	7"

## Dimensions and Pin Configuration

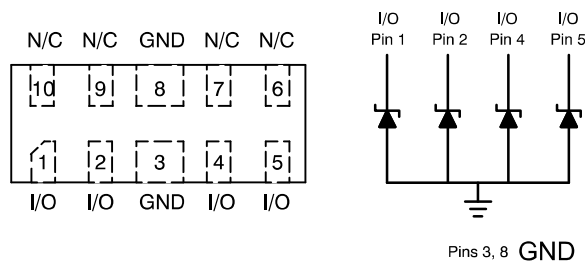

MARKING CODE:

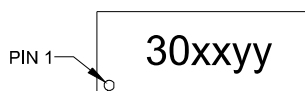

30 = Specific Device Code

xxyy = Date Code

**Absolute Maximum Ratings** (Tamb=25°C unless otherwise specified)

Parameter	Symbol	Value	Unit
Peak Pulse Current (8/20µs)	I <sub>pp</sub>	6.5	A
ESD per IEC 61000-4-2 (Air)	V <sub>ESD</sub>	±20	kV
ESD per IEC 61000-4-2 (Contact)		±15	
Operating Temperature Range	T <sub>J</sub>	-55 to +125	°C
Storage Temperature Range	T <sub>stg</sub>	-55 to +150	°C

**Electrical Characteristics** (TA=25°C unless otherwise specified)

Symbol	Parameter
V <sub>RWM</sub>	Nominal Reverse Working Voltage
I <sub>R</sub>	Reverse Leakage Current @ V <sub>RWM</sub>
V <sub>t1</sub>	Trigger Voltage
I <sub>t1</sub>	Trigger Current @ V <sub>t1</sub>
V <sub>h</sub>	Holding Voltage
I <sub>h</sub>	Holding Current @ V <sub>h</sub>
V <sub>C</sub>	Clamping Voltage @ I <sub>pp</sub>
I <sub>pp</sub>	Maximum Peak Pulse Current
V <sub>F</sub>	Forward Voltage @ I <sub>F</sub>
C <sub>ESD</sub>	Parasitic Capacitance

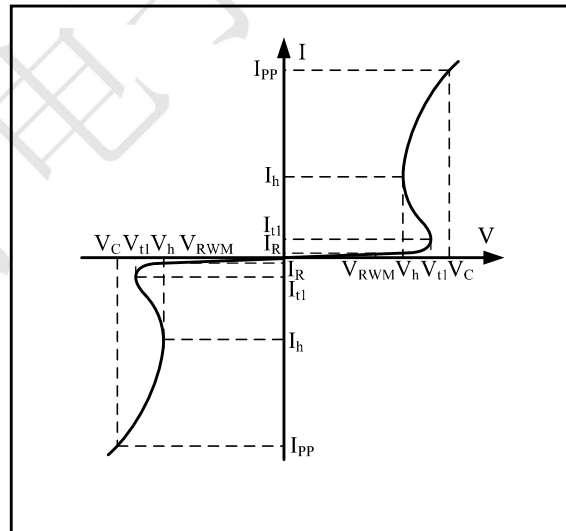

Parameter	Symbol	Min	Typ	Max	Unit	Test Condition
Reverse Working Voltage	V <sub>RWM</sub>			3.3	V	
Trigger Voltage	V <sub>t1</sub>	6		9	V	I <sub>T</sub> = 1mA
Holding Voltage	V <sub>h</sub>	2		3	V	I <sub>h</sub> = 1mA
Reverse Leakage Current	I <sub>R</sub>			0.08	uA	V <sub>RWM</sub> = 3.3V
Clamping Voltage	V <sub>C</sub>		5		V	I <sub>pp</sub> =6A(8x 20us pulse)
Clamping Voltage	V <sub>C</sub>		5.2		V	I <sub>pp</sub> =8A(100ns pulse)
Clamping Voltage	V <sub>C</sub>		7.5		V	I <sub>pp</sub> =16A(100ns pulse)
Junction Capacitance	C <sub>J</sub>		0.18	0.3	pF	V <sub>R</sub> = 0V, f = 1MHz, Between IO and GND
Junction Capacitance	C <sub>J</sub>		0.1	0.2	pF	V <sub>R</sub> = 0V, f = 1MHz, Between IO and IO

**Typical Performance Characteristics ( $T_A=25^\circ\text{C}$  unless otherwise Specified)**

Fig1. 8/20 $\mu\text{s}$  Pulse Waveform

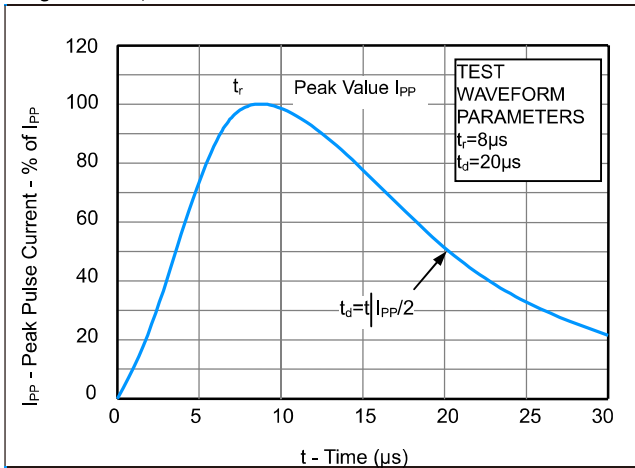

Fig2. ESD Pulse Waveform (according to IEC 61000-4-2)

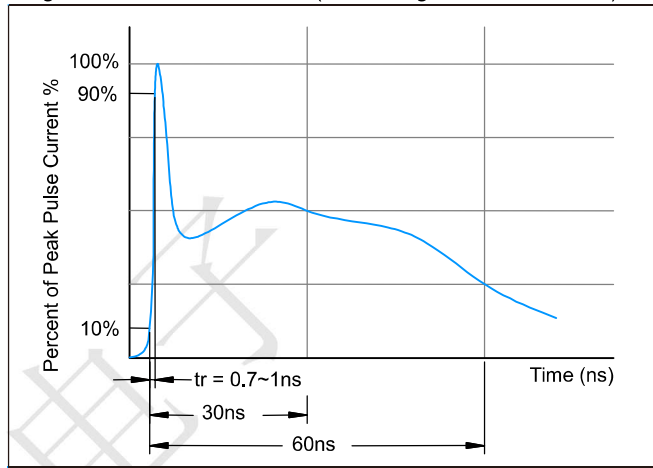
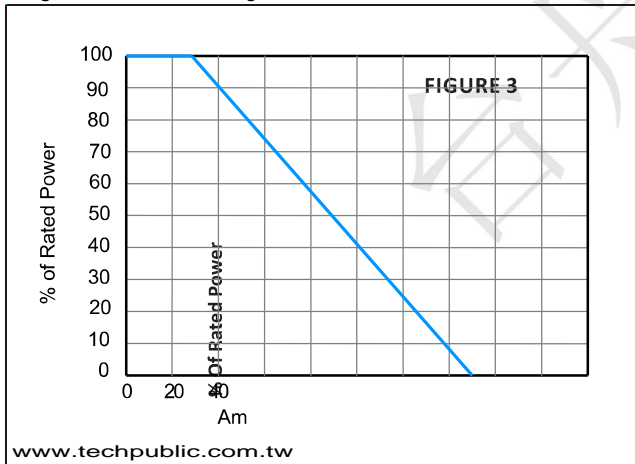
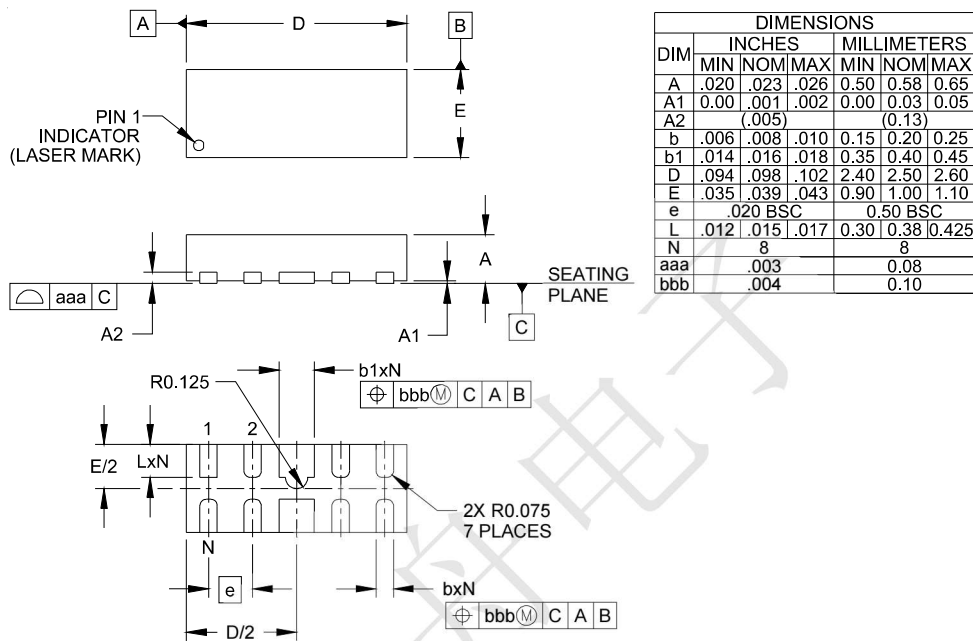

Fig3. Power Derating Curve



[www.techpublic.com.tw](http://www.techpublic.com.tw)

**Outline Drawing - DFN2510-10**



**Land Pattern - DFN2510-10**

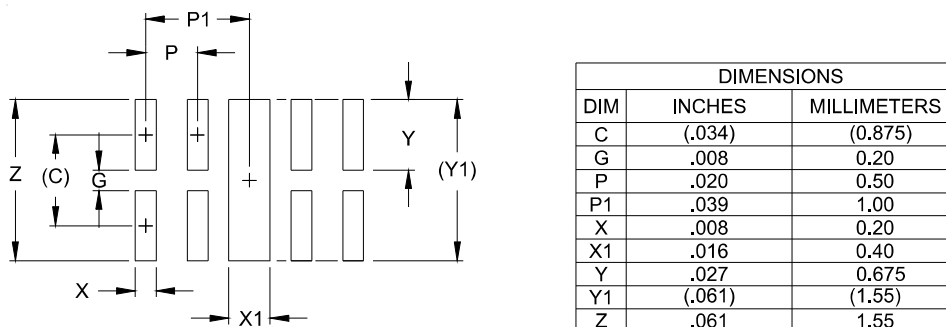

## X-ON Electronics

Largest Supplier of Electrical and Electronic Components

*Click to view similar products for [ESD Suppressors / TVS Diodes](#) category:*

*Click to view products by [TECH PUBLIC](#) manufacturer:*

Other Similar products are found below :

[60KS200C](#) [D18V0L1B2LP-7B](#) [D5V0F4U5P5-7](#) [DESD5V0U1BB-7](#) [NTE4902](#) [P4KE27CA](#) [P6KE11CA](#) [P6KE39CA-TP](#) [P6KE8.2A](#)  
[SA110CA](#) [SA60CA](#) [SA64CA](#) [SMBJ12CATR](#) [SMBJ33CATR](#) [SMBJ8.0A](#) [ESD101-B1-02ELS E6327](#) [ESD105-B1-02EL E6327](#) [ESD112-B1-02EL E6327](#) [ESD119B1W01005E6327XTSA1](#) [ESD5V0L1B02VH6327XTSA1](#) [ESD7451N2T5G](#) [19180-510](#) [CPDT-5V0USP-HF](#)  
[3.0SMCJ33CA-F](#) [3.0SMCJ36A-F](#) [HSPC16701B02TP](#) [D3V3Q1B2DLP3-7](#) [D55V0M1B2WS-7](#) [DESD5V0U1BL-7B](#) [DRTR5V0U4SL-7](#)  
[SCM1293A-04SO](#) [ESD200-B1-CSP0201 E6327](#) [SM12-7](#) [SMF8.0A-TP](#) [SMLJ45CA-TP](#) [CEN955 W/DATA](#) [82350120560](#) [VESD12A1A-](#)  
[HD1-GS08](#) [CPDUR5V0R-HF](#) [CPDQC5V0U-HF](#) [CPDQC5V0USP-HF](#) [CPDQC5V0-HF](#) [D1213A-01LP4-7B](#) [D1213A-02WL-7](#)  
[1SMB33CAT3G-XYZ](#) [MMAD1108/TR13](#) [5KP100A](#) [5KP15A](#) [5KP18A](#) [5KP48A](#)