

Features

- * 2500W peak pulse power (8/20 μ s)
- * Protects one data or power line
- * Operating voltage: 4.5V
- * Ultra low clamping voltage
- * Complies with following standards:
 - IEC 61000-4-2 (ESD) immunity test
 - Air discharge: ± 30 kV
 - Contact discharge: ± 30 kV
 - IEC61000-4-5 (SURGE) 160A (8/20 μ s)

Mechanical Characteristics

- * Package: SOD-323
- * Ultra low leakage: nA level
- * Case Material: "Green" Molding Compound.
- * UL Flammability Classification Rating 94V-0
- * Moisture Sensitivity: Level 3 per J-STD-020

Applications

- * Mobile Phones and Accessories
- * Battery Protection
- * USB VBus
- * Power Line Protection
- * Hand Held Portable Applications

Ordering Information

Part Number	Qty per Reel	Reel Size
TPESD56151W04	3000	7"

Dimensions and Pin Configuration

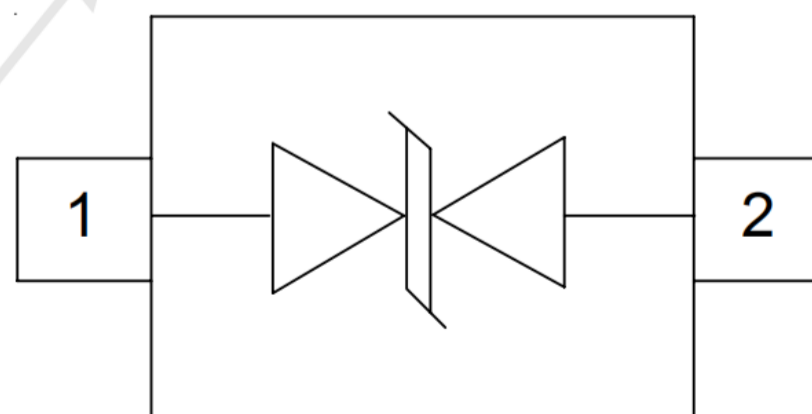

Absolute Maximum Ratings (Tamb=25°C unless otherwise specified)

Parameter	Symbol	Value	Unit
Peak Pulse Power (8/20μs)	Ppk	2500	W
Peak Pulse Current (8/20μs)	I _{PP}	160	A
ESD per IEC 61000-4-2 (Air)	VESD	± 30	kV
ESD per IEC 61000-4-2 (Contact)		± 30	
Operating Temperature Range	T _J	-55 to +125	°C
Storage Temperature Range	T _{stg}	-55 to +150	°C

Electrical Characteristics (TA=25°C unless otherwise specified)

Parameter	Symbol	Min	Typ	Max	Unit	Test Condition
Reverse Working Voltage	V _{RWM}			4.5	V	
Breakdown Voltage	V _{BR}	4.7			V	I _T =1mA
Leakage Current	I _{Leak}			0.8	uA	V _{RWM} =4.5V
Clamping Voltage	V _C		11		V	I _{PP} =100A, T _p =8/20μs
Clamping Voltage	V			15	V	I = 160A, T _p =8/20μs
Junction Capacitance	C _J		320		pF	V _R =0V, f=1MHz

Characteristic Curves

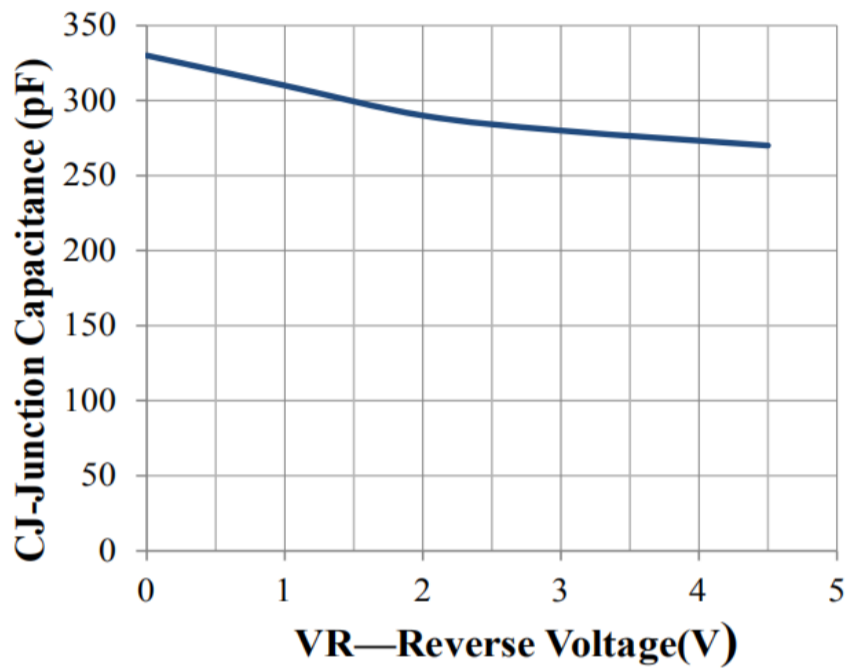

Junction Capacitance vs. Reverse Voltage

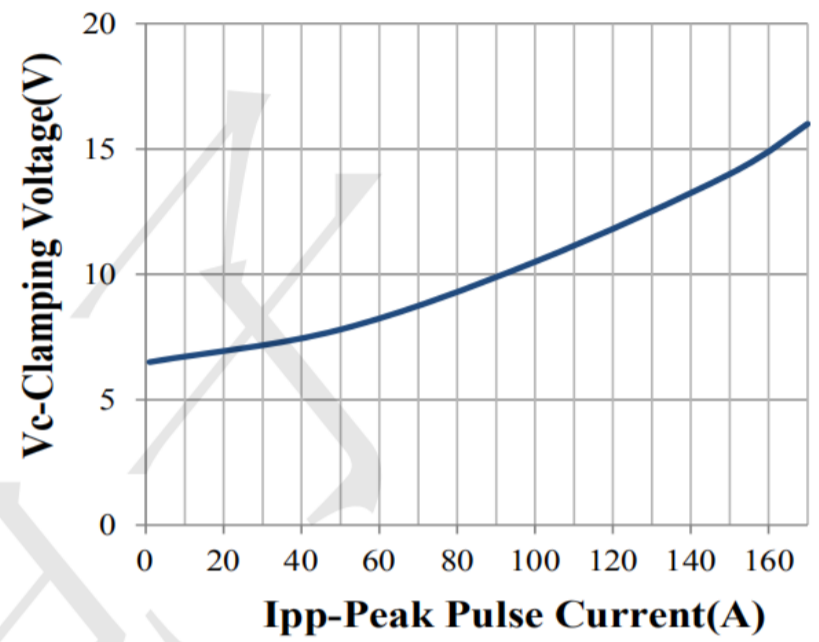

Clamping Voltage vs. Peak Pulse Current

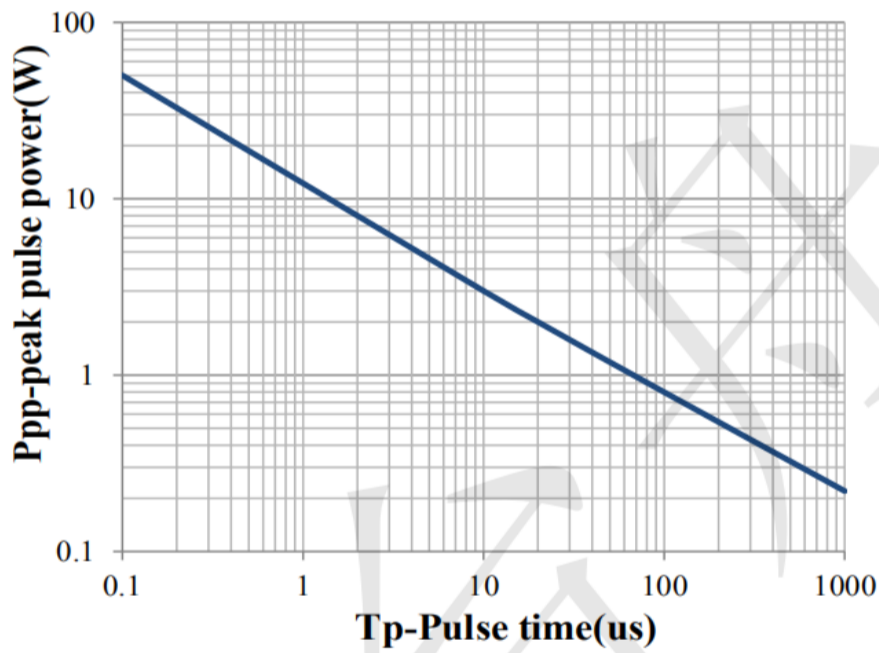

Peak Pulse Power vs. Pulse Time

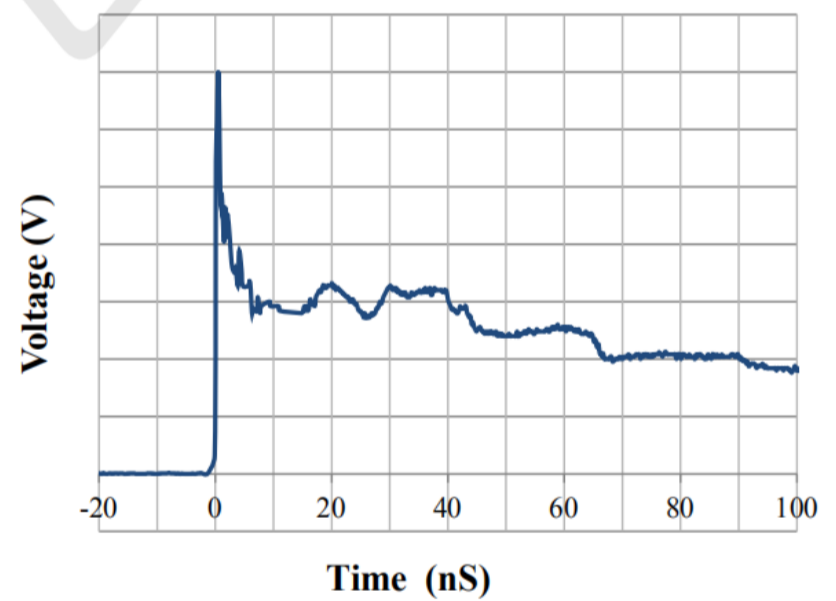

IEC61000-4-2 Pulse Waveform

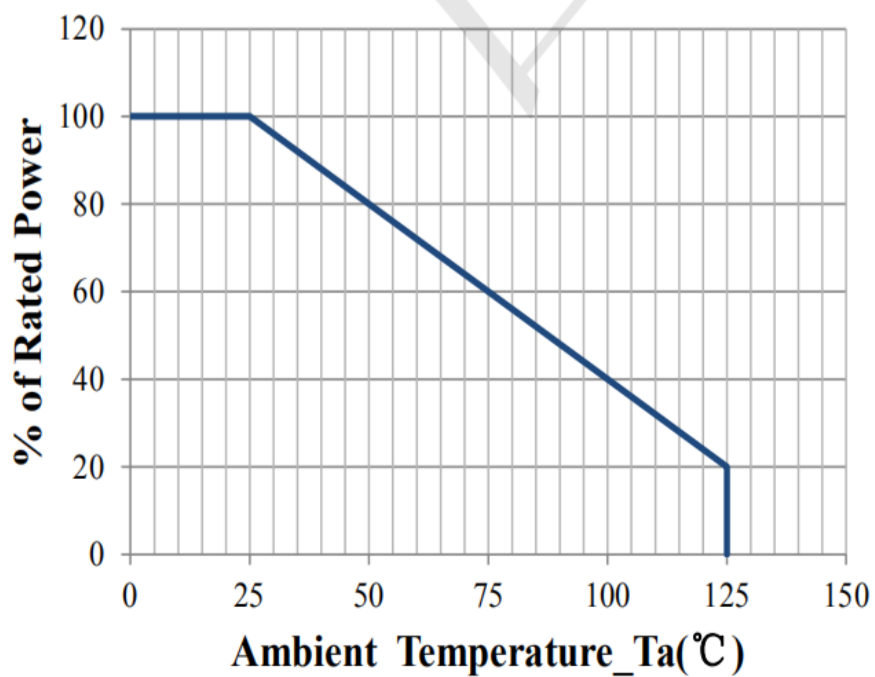

Power Derating Curve

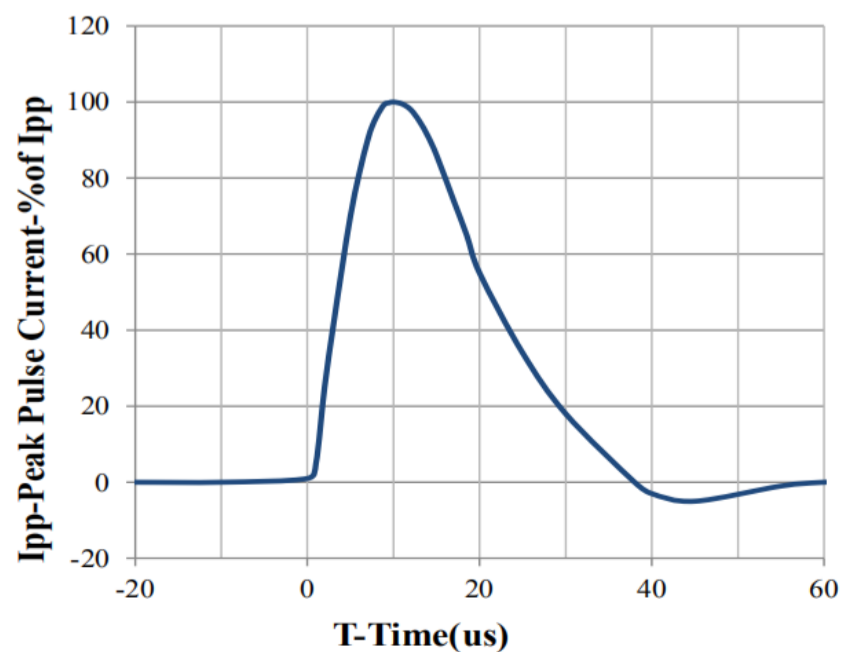

8 X 20us Pulse Waveform

Outline Drawing -SOD323

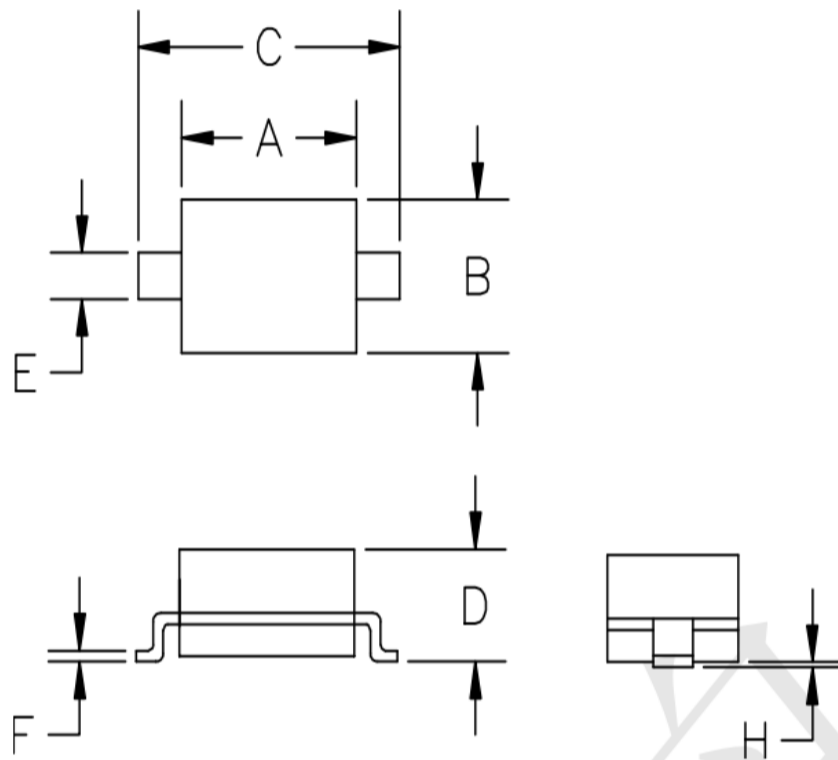

SYM	DIMENSIONS			
	MILLIMETERS		INCHES	
	MIN	MAX	MIN	MAX
A	1.50	1.80	0.060	0.071
B	1.20	1.40	0.045	0.054
C	2.30	2.70	0.090	0.107
D	-	1.10	-	0.043
E	0.30	0.40	0.012	0.016
F	0.10	0.25	0.004	0.010
H	-	0.10	-	0.004

Land Pattern - SOD323

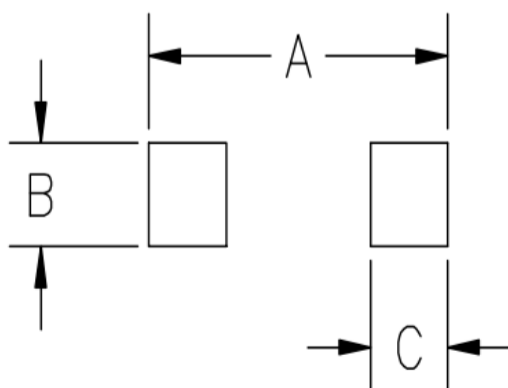

SYM	DIMENSIONS	
	MILLIMETERS	INCHES
A	3.15	0.120
B	0.80	0.031
C	0.80	0.031

X-ON Electronics

Largest Supplier of Electrical and Electronic Components

Click to view similar products for [ESD Suppressors / TVS Diodes](#) category:

Click to view products by [TECH PUBLIC](#) manufacturer:

Other Similar products are found below :

[60KS200C](#) [D18V0L1B2LP-7B](#) [D5V0F4U5P5-7](#) [DESD5V0U1BB-7](#) [NTE4902](#) [P4KE27CA](#) [P6KE11CA](#) [P6KE39CA-TP](#) [P6KE8.2A](#)
[SA110CA](#) [SA60CA](#) [SA64CA](#) [SMBJ12CATR](#) [SMBJ33CATR](#) [SMBJ8.0A](#) [ESD101-B1-02ELS E6327](#) [ESD105-B1-02EL E6327](#) [ESD112-B1-02EL E6327](#) [ESD119B1W01005E6327XTSA1](#) [ESD5V0L1B02VH6327XTSA1](#) [ESD7451N2T5G](#) [19180-510](#) [CPDT-5V0USP-HF](#)
[3.0SMCJ33CA-F](#) [3.0SMCJ36A-F](#) [HSPC16701B02TP](#) [D3V3Q1B2DLP3-7](#) [D55V0M1B2WS-7](#) [DESD5V0U1BL-7B](#) [DRTR5V0U4SL-7](#)
[SCM1293A-04SO](#) [ESD200-B1-CSP0201 E6327](#) [SM12-7](#) [SMF8.0A-TP](#) [SMLJ45CA-TP](#) [SMQA1000T1G](#) [CEN955 W/DATA](#) [82350120560](#)
[VESD12A1A-HD1-GS08](#) [CPDUR5V0R-HF](#) [CPDQC5V0U-HF](#) [CPDQC5V0USP-HF](#) [CPDQC5V0-HF](#) [IP4042CX5/LF,135](#) [D1213A-01LP4-7B](#) [D1213A-02WL-7](#) [1SMB33CAT3G-XYZ](#) [MMAD1108/TR13](#) [5KP100A](#) [5KP15A](#)