

## Features

- Low operating voltage: 5V
- Ultra low capacitance: 0.2 pF typical (IO to IO)
- Ultra low leakage: nA level
- Low clamping voltage
- Complies with following standards:
  - - IEC 61000-4-2 (ESD) immunity test
    - Air discharge:  $\pm 22\text{kV}$
    - Contact discharge:  $\pm 20\text{kV}$
  - - IEC61000-4-5 (Lightning) 3A (8/20  $\mu\text{s}$ )
- These are Pb-Free Devices
- Response Time is Typically  $< 1\text{ ns}$

## Mechanical Characteristics

- Package: TSFP-3
- Lead Finish: Matte Tin
- Case Material: "Green" Molding Compound.
- Moisture Sensitivity: Level 3 per J-STD-020
- Terminal Connections: See Diagram Below
- Shipping Qty : 8000pcs/7Inch Tape & Reel

## Applications

- Cellular Handsets and Accessories
- Personal Digital Assistants
- Notebooks and Handhelds
- Portable Instrumentation
- Digital Cameras
- Peripherals

## Dimensions and Pin Configuration

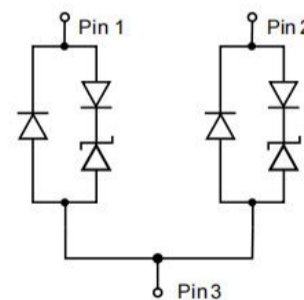
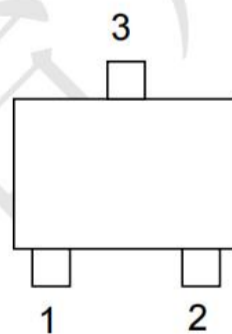

**Absolute Maximum Ratings** (Tamb=25°C unless otherwise specified)

Parameter	Symbol	Value	Unit
Peak Pulse Current (8/20μs)	Ipp	3	A
ESD per IEC 61000-4-2 (Air)	VESD	±22	kV
ESD per IEC 61000-4-2 (Contact)		±20	
Operating Temperature Range	TJ	-55 to +125	°C
Storage Temperature Range	Tstg	-55 to +150	°C

**Electrical Characteristics** (TA=25°C unless otherwise specified)

Parameter	Symbol	Min	Typ	Max	Unit	Test Condition
Reverse Working Voltage	VRWM			5	V	
Breakdown Voltage	VBR	6	7.5	8.6	V	IT = 1mA
Reverse Leakage Current	IR			0.07	uA	VRWM = 5V
Clamping Voltage	VC			12	V	Ipp=1A(8x 20us pulse)
Clamping Voltage	VC			20	V	Ipp=3A(8x 20us pulse)
Junction Capacitance	CJ		0.35		pF	VR = 0V, f = 1MHz IO to GND
Junction Capacitance	CJ		0.2	0.25	pF	VR = 0V, f = 1MHz IO to IO

**Typical Performance Characteristics ( $T_A=25^\circ\text{C}$  unless otherwise Specified)**

Fig1. 8/20 $\mu\text{s}$  Pulse Waveform

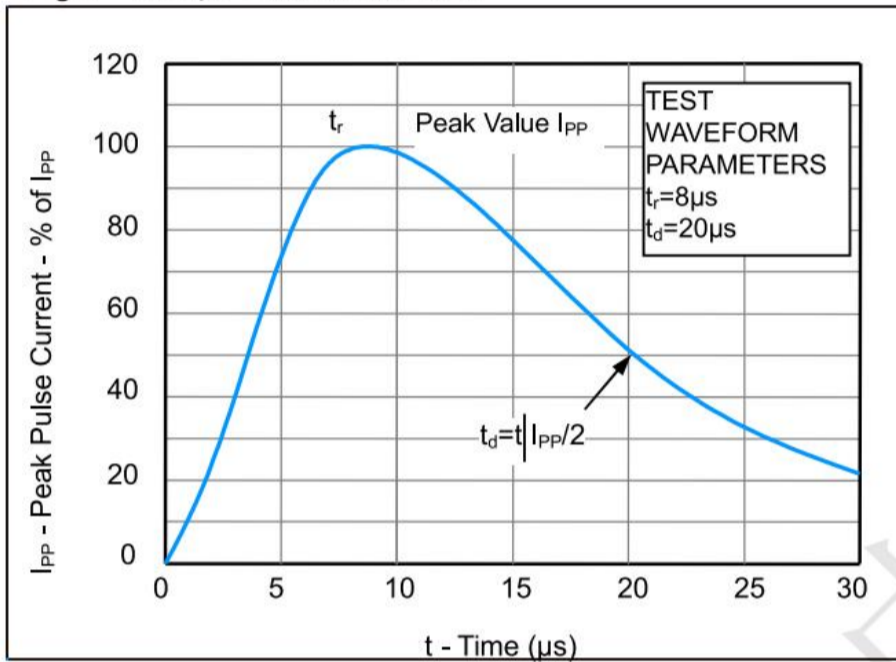

Fig2. ESD Pulse Waveform (according to IEC 61000-4-2)

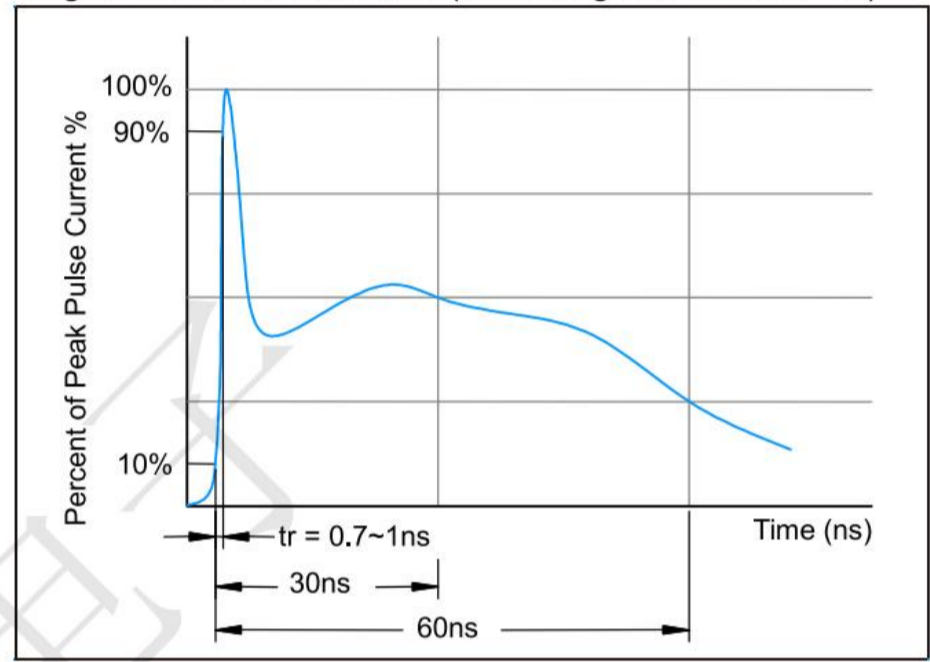
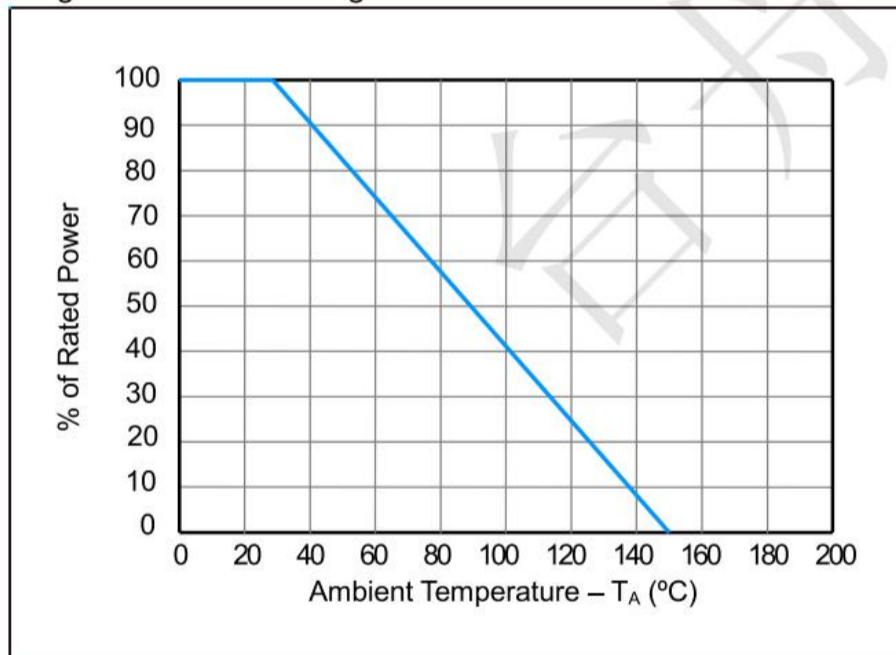

Fig3. Power Derating Curve





**TSFP-3 Package Outline Dimensions**

[www.sot23.com.tw](http://www.sot23.com.tw)

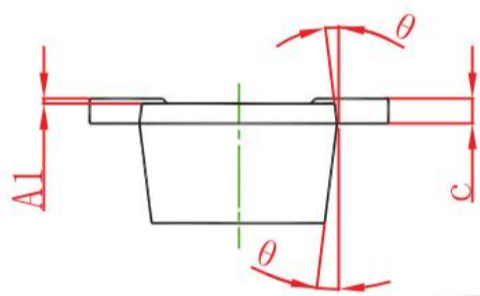
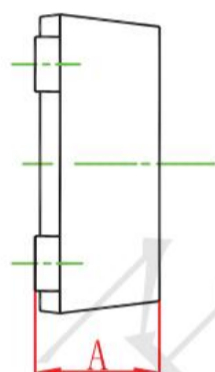
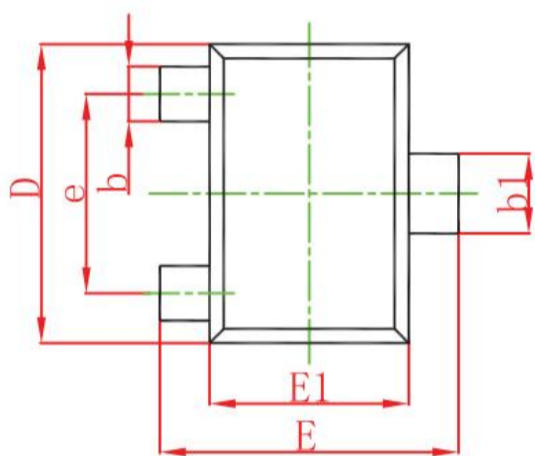

Symbol	Dimensions In Millimeters		Dimensions In Inches	
	Min.	Max.	Min.	Max.
A	0.430	0.500	0.017	0.020
A1	0.000	0.050	0.000	0.002
b	0.170	0.270	0.007	0.011
b1	0.270	0.370	0.011	0.015
c	0.080	0.150	0.003	0.006
D	1.150	1.250	0.045	0.049
E	1.150	1.250	0.045	0.049
E1	0.750	0.850	0.030	0.033
e	0.800TYP.		0.031TYP.	
$\theta$	7° REF.		7° REF.	

## X-ON Electronics

Largest Supplier of Electrical and Electronic Components

*Click to view similar products for [ESD Suppressors / TVS Diodes](#) category:*

*Click to view products by [TECH PUBLIC](#) manufacturer:*

Other Similar products are found below :

[60KS200C](#) [D18V0L1B2LP-7B](#) [D5V0F4U5P5-7](#) [DESD5V0U1BB-7](#) [NTE4902](#) [P4KE27CA](#) [P6KE11CA](#) [P6KE39CA-TP](#) [P6KE8.2A](#)  
[SA110CA](#) [SA60CA](#) [SA64CA](#) [SMBJ12CATR](#) [SMBJ33CATR](#) [SMBJ8.0A](#) [ESD101-B1-02ELS E6327](#) [ESD105-B1-02EL E6327](#) [ESD112-B1-02EL E6327](#) [ESD119B1W01005E6327XTSA1](#) [ESD5V0L1B02VH6327XTSA1](#) [ESD7451N2T5G](#) [19180-510](#) [CPDT-5V0USP-HF](#)  
[3.0SMCJ33CA-F](#) [3.0SMCJ36A-F](#) [HSPC16701B02TP](#) [D3V3Q1B2DLP3-7](#) [D55V0M1B2WS-7](#) [DESD5V0U1BL-7B](#) [DRTR5V0U4SL-7](#)  
[SCM1293A-04SO](#) [ESD200-B1-CSP0201 E6327](#) [SM12-7](#) [SMF8.0A-TP](#) [SMLJ45CA-TP](#) [CEN955 W/DATA](#) [82350120560](#) [VESD12A1A-](#)  
[HD1-GS08](#) [CPDUR5V0R-HF](#) [CPDQC5V0U-HF](#) [CPDQC5V0USP-HF](#) [CPDQC5V0-HF](#) [D1213A-01LP4-7B](#) [D1213A-02WL-7](#)  
[1SMB33CAT3G-XYZ](#) [MMAD1108/TR13](#) [5KP100A](#) [5KP15A](#) [5KP18A](#) [5KP48A](#)