

Features

- V_{DS} 20V
- I_D 2.5A
- $R_{DS(ON)}$ (at $V_{GS}=4.5V$) <70 mohm
- $R_{DS(ON)}$ (at $V_{GS}=2.5V$) <98 mohm

Applications

- Battery protection
- Load switch
- Power management



SOT323

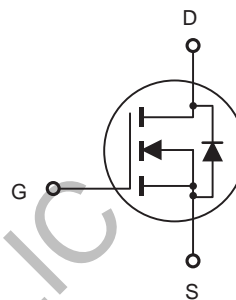

Absolute Maximum Ratings ($T_A=25^\circ C$ unless otherwise specified)

Parameter	Symbol	Limit	Unit
Drain-source Voltage	V_{DS}	20	V
Gate-source Voltage	V_{GS}	± 10	V
Drain Current	I_D	$T_A=25^\circ C$ @ Steady State	2.5
		$T_A=70^\circ C$ @ Steady State	2.0
Pulsed Drain Current ^A	I_{DM}	14	A
Total Power Dissipation @ $T_A=25^\circ C$	P_D	0.7	W
Thermal Resistance Junction-to-Ambient @ Steady State ^B	$R_{\theta JA}$	178	$^\circ C/W$
Junction and Storage Temperature Range	T_J, T_{STG}	-55~+150	$^\circ C$

Electrical Characteristics (T =25°C unless otherwise specified)

Parameter	Symbol	Conditions	Min	Typ	Max	Units
Static Parameter						
Drain-Source Breakdown Voltage	BV_{DSS}	$V_{GS}=0V, I_D=250\mu A$	20			V
Zero Gate Voltage Drain Current	I_{DSS}	$V_{DS}=20V, V_{GS}=0V, T_C=25^\circ C$			1	μA
Gate-Body Leakage Current	I_{GSS}	$V_{GS}= \pm 10V, V_{DS}=0V$			± 100	nA
Gate Threshold Voltage	$V_{GS(th)}$	$V_{DS}= V_{GS}, I_D=250\mu A$	0.55	0.78	1.1	V
Static Drain-Source On-Resistance	$R_{DS(on)}$	$V_{GS}= 4.5V, I_D=2.5A$		57	70	m Ω
		$V_{GS}= 2.5V, I_D=2.0A$		72	98	
Diode Forward Voltage	V_{SD}	$I_S=2.5A, V_{GS}=0V$			1.2	V
Maximum Body-Diode Continuous Current	I_S				2.5	A
Dynamic Parameters						
Input Capacitance	C_{iss}	$V_{DS}=10V, V_{GS}=0V, f=1MHz$		280		pF
Output Capacitance	C_{oss}			46		
Reverse Transfer Capacitance	C_{rss}			29		
Switching Parameters						
Total Gate Charge	Q_g	$V_{GS}=4.5V, V_{DS}=10V, I_D=2.5A$		2.9		nC
Gate Source Charge	Q_{gs}			0.4		
Gate Drain Charge	Q_{gd}			0.6		
Turn-on Delay Time	$t_{D(on)}$	$V_{GS}=4.5V, V_{DD}=10V, R_L=1.5\Omega, R_{GEN}=3\Omega$		13		ns
Turn-on Rise Time	t_r			54		
Turn-off Delay Time	$t_{D(off)}$			18		
Turn-off Fall Time	t_f			11		

Outline Drawing - SOT323

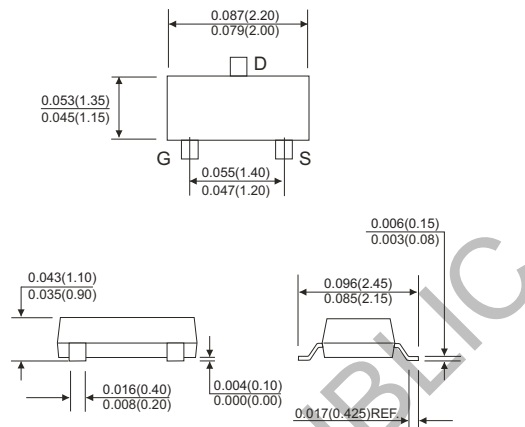

X-ON Electronics

Largest Supplier of Electrical and Electronic Components

Click to view similar products for [MOSFET](#) category:

Click to view products by [TECH PUBLIC](#) manufacturer:

Other Similar products are found below :

[614233C](#) [648584F](#) [MCH3443-TL-E](#) [MCH6422-TL-E](#) [FDPF9N50NZ](#) [FW216A-TL-2W](#) [FW231A-TL-E](#) [APT5010JVR](#) [NTNS3A92PZT5G](#)
[IRF100S201](#) [JANTX2N5237](#) [2SK2464-TL-E](#) [2SK3818-DL-E](#) [FCA20N60_F109](#) [FDZ595PZ](#) [STD6600NT4G](#) [FSS804-TL-E](#) [2SJ277-DL-E](#)
[2SK1691-DL-E](#) [2SK2545\(Q,T\)](#) [D2294UK](#) [405094E](#) [423220D](#) [MCH6646-TL-E](#) [TPCC8103,L1Q\(CM](#) [367-8430-0972-503](#) [VN1206L](#)
[424134F](#) [026935X](#) [051075F](#) [SBVS138LT1G](#) [614234A](#) [715780A](#) [NTNS3166NZT5G](#) [751625C](#) [873612G](#) [IRF7380TRHR](#)
[IPS70R2K0CEAKMA1](#) [RJK60S3DPP-E0#T2](#) [RJK60S5DPK-M0#T0](#) [APT5010JVFR](#) [APT12031JFLL](#) [APT12040JVR](#) [DMN3404LQ-7](#)
[NTE6400](#) [JANTX2N6796U](#) [JANTX2N6784U](#) [JANTXV2N5416U4](#) [SQM110N05-06L-GE3](#) [SIHF35N60E-GE3](#)