

Features

- $V_{DS} = -30V, I_D = -80A$
- $R_{DS(ON)} \leq 8m\Omega @ V_{GS} = -10V$
- $R_{DS(ON)} \leq 11m\Omega @ V_{GS} = -4.5V$

Application

- Load/Power Switching
- Interfacing Switching
- Battery Management for Ultra Small Portable
- Electronics
- Logic Level Shift

Package and Pin Configuration

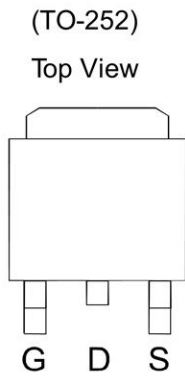

1. GATE
2. DRAIN
3. SOURCE



Marking:

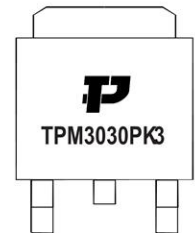

Absolute Maximum Ratings (TA=25°C Unless Otherwise Noted)

Parameter	Symbol	Maximum Ratings	Unit
Drain-Source Voltage	V_{DS}	-30	V
Gate-Source Voltage	V_{GS}	± 20	V
Continuous Drain Current*	I_D	$T_C = 25^\circ C$	-80
		$T_C = 70^\circ C$	-65
Pulsed Drain Current (Package limited)	I_{DM}	-200	A
Maximum Power Dissipation*	P_D	$T_C = 25^\circ C$	83
		$T_C = 70^\circ C$	53
Operating Junction Temperature	T_J	-55 to 150	°C
Thermal Resistance-Junction to Case*	$R_{\theta JC}$	1.5	

Electrical Characteristics (TA=25°C Unless Otherwise Specified)

Symbol	Parameter	Limit	Min	Typ	Max	Unit
STATIC						
V _{(BR)DSS}	Drain-Source Breakdown Voltage	V _{GS} =0V, I _D =-250 μA	-30			V
V _{GS(th)}	Gate Threshold Voltage	V _{DS} =V _{GS} , I _D =-250 μA	-1		-3	V
I _{GSS}	Gate Leakage Current	V _{DS} =0V, V _{GS} =±20V			±100	nA
I _{DSS}	Zero Gate Voltage Drain Current	V _{DS} =-30V, V _{GS} =0V			-1	μA
R _{DS(on)}	Drain-Source On-State Resistance ^a	V _{GS} =-10V, I _D = -20A		6.7	8	mΩ
		V _{GS} =-4.5V, I _D = -20A		8.4	11	
V _{SD}	Diode Forward Voltage	I _S =-1A, V _{GS} =0V		-0.7	-1.2	V
DYNAMIC						
Q _g	Total Gate Charge	V _{DS} =-15V, V _{GS} =-10V, I _D =-20A		88		nC
Q _g	Total Gate Charge			44		
Q _{gs}	Gate-Source Charge	V _{DS} =-15V, V _{GS} =-4.5V, I _D =-20A		12.5		
Q _{gd}	Gate-Drain Charge			19.5		
C _{iss}	Input capacitance			3887		pF
C _{oss}	Output Capacitance	V _{DS} =-15V, V _{GS} =0V, F=1MHz		432		
C _{rss}	Reverse Transfer Capacitance			372		
t _{d(on)}	Turn-On Delay Time			48		ns
t _r	Turn-On Rise Time	V _{DS} =-15V, R _L =15Ω		20		
t _{d(off)}	Turn-Off Delay Time	V _{GS} =-10V, R _G =6Ω		170		
t _f	Turn-Off Fall Time	I _D =-1A		54		

Notes: a. Pulse test: pulse width ≤ 300us, duty cycle ≤ 2%, Guaranteed by design, not subject to production testing.

b. Matsuki Electric/ Force mos reserves the right to improve product design, functions and reliability without notice.

Typical Characteristics

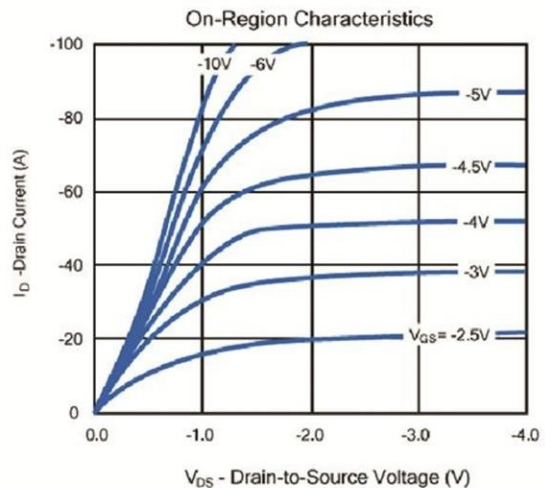
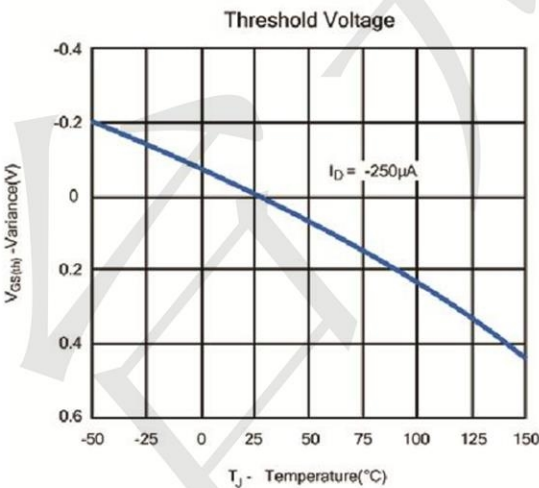
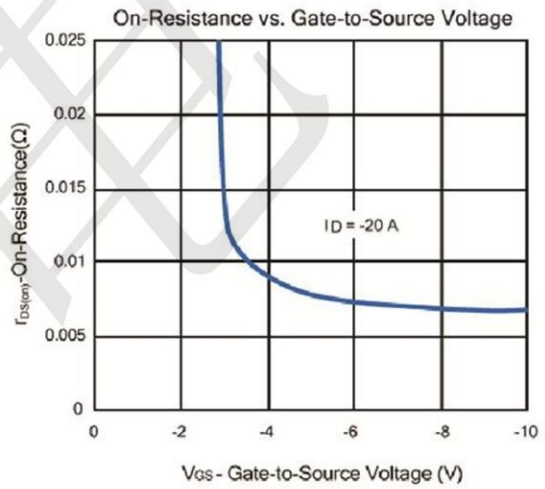
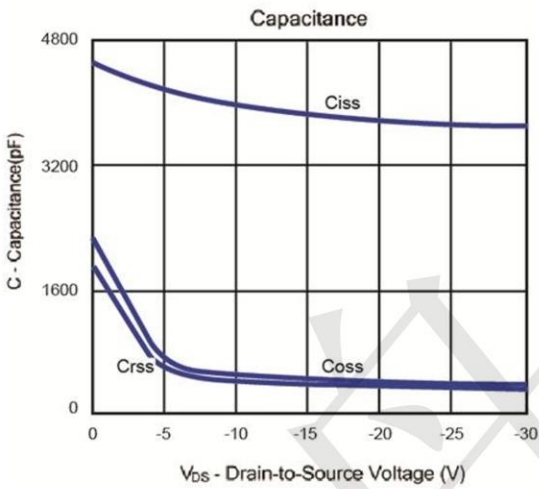
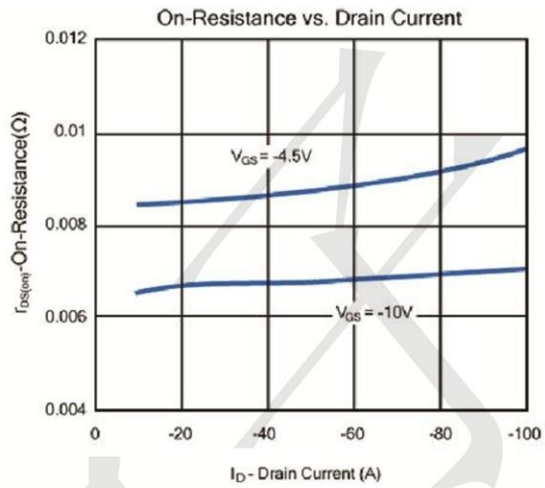
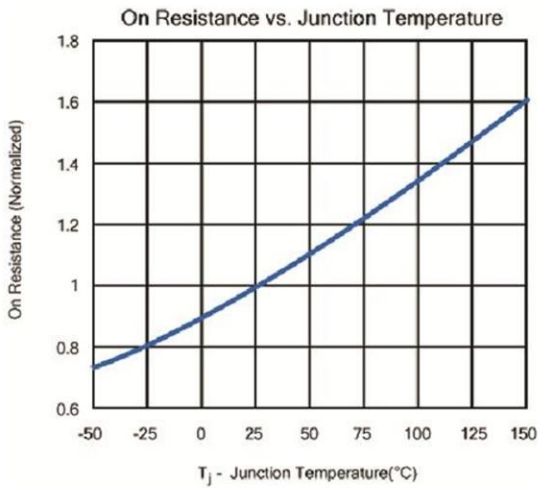

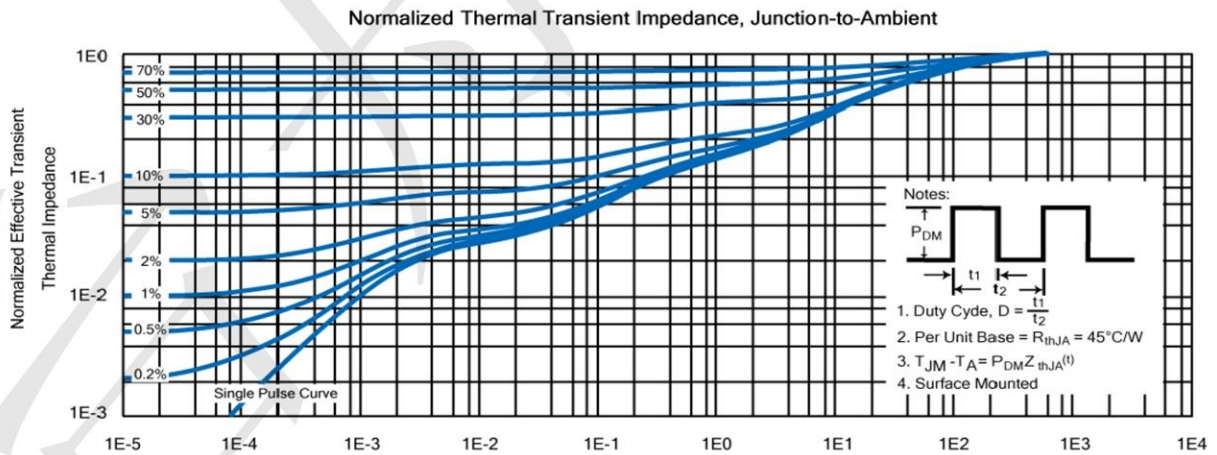
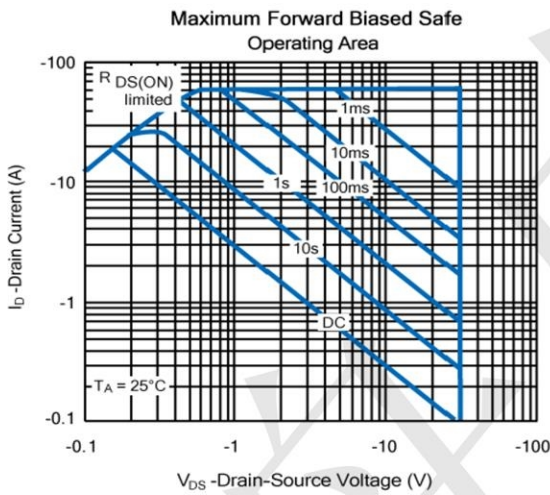
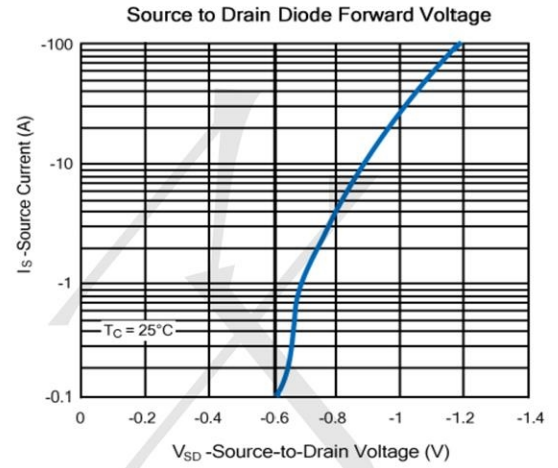
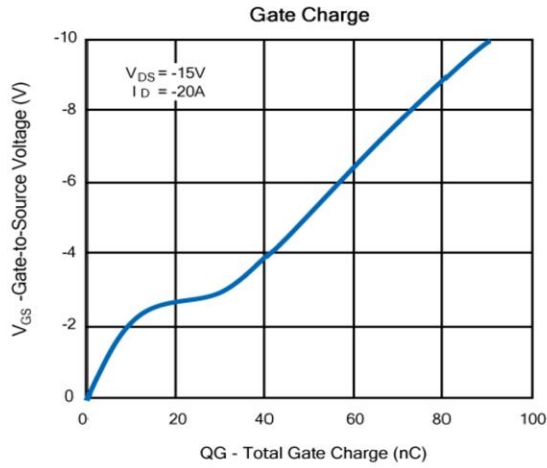
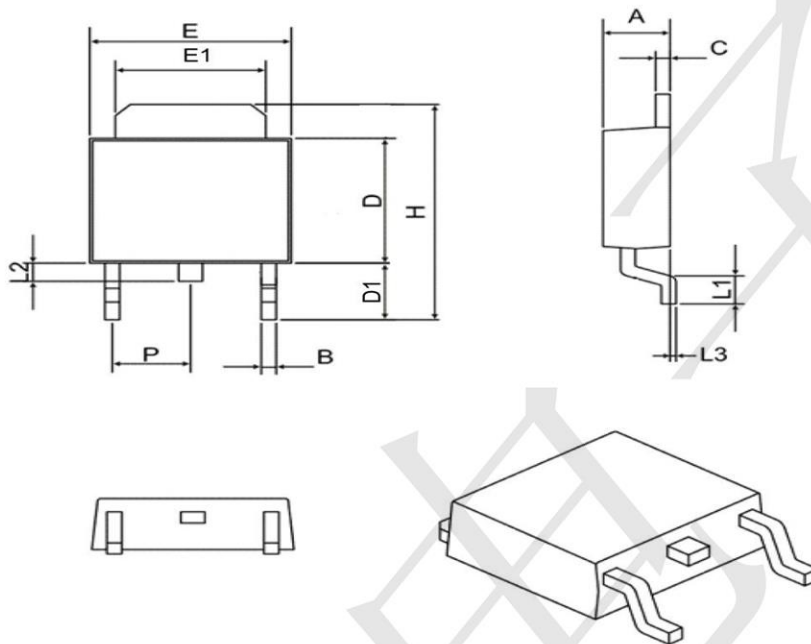

Figure 11 Normalized Maximum Transient Thermal Impedance



TO252 Package Information



SYMBOL	MIN	MAX
A	2.10	2.50
B	0.40	0.90
C	0.40	0.90
D	5.30	6.30
D1	2.20	2.90
E	6.30	6.75
E1	4.80	5.50
L1	0.90	1.80
L2	0.50	1.10
L3	0.00	0.20
H	8.90	10.40
P	2.30 BSC	

X-ON Electronics

Largest Supplier of Electrical and Electronic Components

Click to view similar products for [MOSFET](#) category:

Click to view products by [TECH PUBLIC](#) manufacturer:

Other Similar products are found below :

[IRFD120](#) [JANTX2N5237](#) [2SK2267\(Q\)](#) [BUK455-60A/B](#) [TK100A10N1,S4X\(S](#) [MIC4420CM-TR](#) [VN1206L](#) [NDP4060](#) [SI4482DY](#)
[IRS2092STRPBF-EL](#) [IPS70R2K0CEAKMA1](#) [TK31J60W5,S1VQ\(O](#) [TK31J60W,S1VQ\(O](#) [TK16J60W,S1VQ\(O](#) [2SK2614\(TE16L1,Q\)](#)
[DMN1017UCP3-7](#) [EFC2J004NUZTDG](#) [P85W28HP2F-7071](#) [DMN1053UCP4-7](#) [NTE2384](#) [DMC2700UDMQ-7](#) [DMN2080UCB4-7](#)
[DMN61D9UWQ-13](#) [US6M2GTR](#) [DMN31D5UDJ-7](#) [DMP22D4UFO-7B](#) [IPS60R3K4CEAKMA1](#) [DMN1006UCA6-7](#) [DMN16M9UCA6-7](#)
[STF5N65M6](#) [IRF40H233XTMA1](#) [STU5N65M6](#) [DMN6022SSD-13](#) [DMN13M9UCA6-7](#) [DMTH10H4M6SPS-13](#) [IPS60R360PFD7SAKMA1](#)
[DMN2990UFB-7B](#) [SSM3K35CT,L3F](#) [IPLK60R1K0PFD7ATMA1](#) [2N7002W-G](#) [MCAC30N06Y-TP](#) [IPWS65R035CFD7AXKSA1](#)
[MCQ7328-TP](#) [SSM3J143TU,LXHF](#) [DMN12M3UCA6-7](#) [PJMF280N65E1_T0_00201](#) [PJMF380N65E1_T0_00201](#)
[PJMF280N60E1_T0_00201](#) [PJMF600N65E1_T0_00201](#) [PJMF900N65E1_T0_00201](#)