

Features

- Fast switching
- Green Device Available
- Suit for 1.5V Gate Drive Applications

Application

- Notebook
- Load Switch
- Networking
- Hand-held Instruments

Package and Pin Configuration

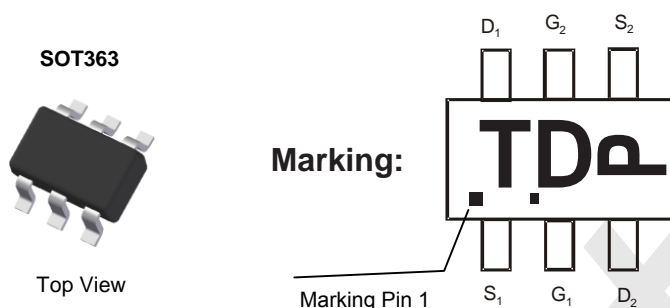

Circuit diagram

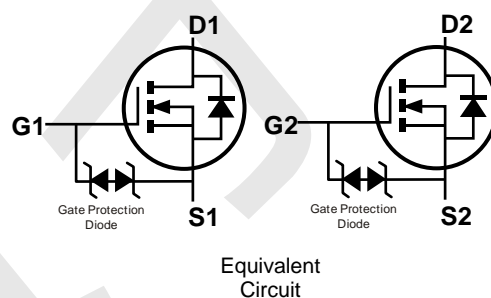

Package orientation in reel

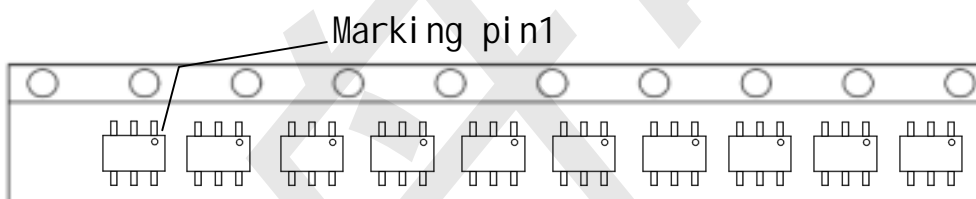

Shipping: 3000pcs / Tape & Reel

Absolute Maximum Ratings (T_A=25°C unless otherwise noted)

Parameter	Symbol	Value	Unit
Drain-Source Voltage	V _{DS}	20	V
Gate-Source Voltage	V _{GS}	±8	V
Continuous Drain Current	I _D	0.7	A
Pulsed Drain Current (t=300μs) ⁽¹⁾	I _{DM}	1.8	A
Power Dissipation ⁽²⁾	P _D	100	mW
Thermal Resistance from Junction to Ambient	R _{θJA}	833	°C/W
Junction Temperature	T _J	150	°C
Storage Temperature	T _{STG}	-55~ +150	°C

Electrical Characteristics ($T_A = 25^\circ\text{C}$ unless otherwise noted)

Parameter	Symbol	Test Condition	Min	Type	Max	Unit
Static Characteristics						
Drain-source breakdown voltage	$V_{(BR)DSS}$	$V_{GS} = 0V, I_D = 250\mu A$	20			V
Zero gate voltage drain current	I_{DSS}	$V_{DS} = 20V, V_{GS} = 0V$			1	μA
Gate-body leakage current	I_{GSS}	$V_{GS} = \pm 8V, V_{DS} = 0V$			± 10	μA
Gate threshold voltage ⁽³⁾	$V_{GS(th)}$	$V_{DS} = V_{GS}, I_D = 250\mu A$	0.5	0.75	1.5	V
Drain-source on-resistance ⁽³⁾	$R_{DS(on)}$	$V_{GS} = 4.5V, I_D = 650mA$		130	330	m Ω
		$V_{GS} = 2.5V, I_D = 550mA$			410	
Forward tranconductance	g_{FS}	$V_{DS} = 10V, I_D = 500mA$			1.2	S
Dynamic characteristics⁽⁴⁾						
Input Capacitance	C_{iss}	$V_{DS} = 16V, V_{GS} = 0V, f = 1MHz$			120	pF
Output Capacitance	C_{oss}				20	
Reverse Transfer Capacitance	C_{rss}				15	
Switching Characteristics⁽⁴⁾						
Turn-on delay time	$t_{d(on)}$	$V_{DD} = 10V, I_D = 500mA,$ $V_{GS} = 4.5V, R_G = 10\Omega$		6.7		ns
Turn-on rise time	t_r			4.8		
Turn-off delay time	$t_{d(off)}$			17.3		
Turn-off fall time	t_f			7.4		
Source-Drain Diode characteristics						
Diode Forward voltage ⁽³⁾	V_{DS}	$I_S = 0.15A, V_{GS} = 0V$			1.2	V

Outline Drawing - SOT-363(2.0X2.1)

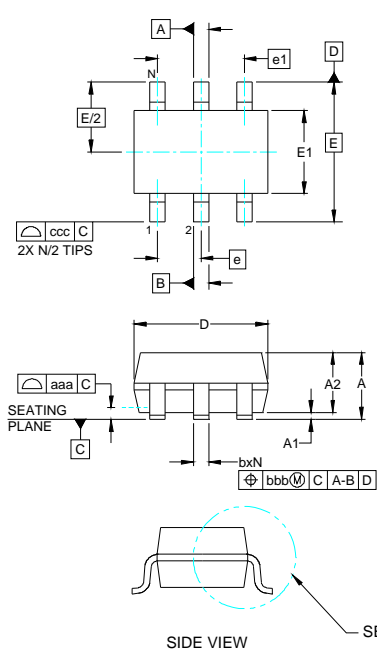

DIM	INCHES			MILLIMETERS		
	MIN	NOM	MAX	MIN	NOM	MAX
A	-	-	.043	-	-	1.10
A1	.000	-	.004	0.00	-	0.10
A2	.028	.035	.039	0.70	0.90	1.00
b	.006	-	.012	0.15	-	0.30
c	.003	-	.009	0.08	-	0.22
D	.071	.079	.087	1.80	2.00	2.20
E	.045	.049	.053	1.15	1.25	1.35
E	.083 BSC			2.10 BSC		
e	.026 BSC			0.65 BSC		
e1	.051			1.30 BSC		
L	.010	.014	.018	0.26	0.36	0.46
L1	(0.17)			(0.42)		
N	6			6		
ø1	0°	-	8°	0°	-	8°
aaa	.004			0.10		
bbb	.004			0.10		
ccc	.012			0.30		

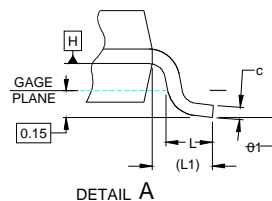

Land Pattern - SOT-363

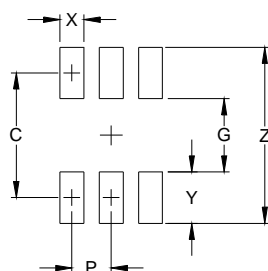

DIMENSIONS		
DIM	INCHES	MILLIMETERS
C	(.073)	(1.85)
G	.039	1.00
P	.026	0.65
X	.016	0.40
Y	.033	0.85
Z	.106	2.70

SOT-363 Embossed Carrier Tape

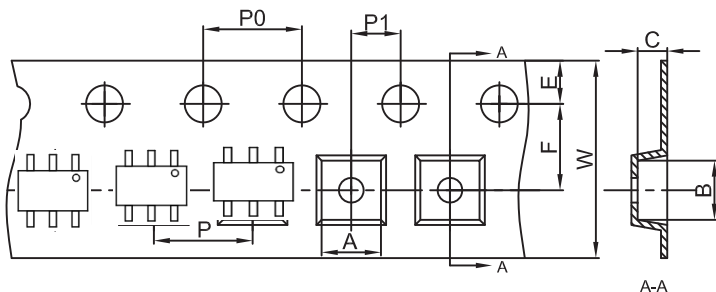

Dimensions are in millimeter											
Pkg type	A	B	C	d	E	F	P0	P	P1	W	
SOT-363	2.25	2.55	1.20	Ø1.50	1.75	3.50	4.00	4.00	2.00	8.00	

SOT-363 Tape Leader and Trailer

Package orientation in reel

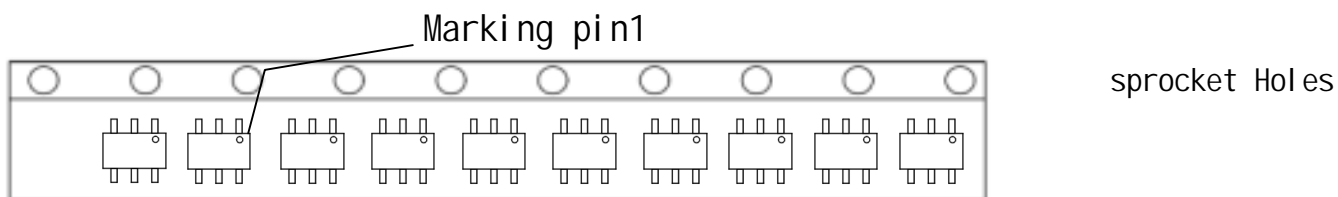

Shipping: 3000pcs / Tape & Reel

SOT-363 Reel

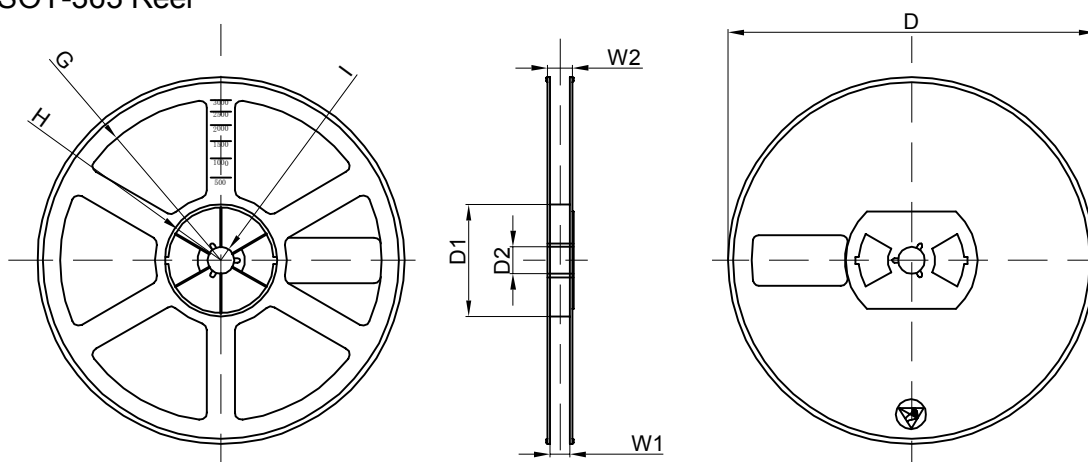

Dimensions are in millimeter								
Reel Option	D	D1	D2	G	H	I	W1	W2
7" Dia	Ø178.00	54.40	13.00	R78.00	R25.60	R6.50	9.50	12.30

REEL	Reel Size	Box	Box Size(mm)	Carton	Carton Size(mm)	G.W.(kg)
3000 pcs	7 inch	45,000 pcs	203×203×195	180,000 pcs	438×438×220	

X-ON Electronics

Largest Supplier of Electrical and Electronic Components

Click to view similar products for [MOSFET](#) category:

Click to view products by [TECH PUBLIC](#) manufacturer:

Other Similar products are found below :

[IRFD120](#) [JANTX2N5237](#) [2SK2267\(Q\)](#) [BUK455-60A/B](#) [TK100A10N1,S4X\(S](#) [MIC4420CM-TR](#) [VN1206L](#) [NDP4060](#) [SI4482DY](#)
[IRS2092STRPBF-EL](#) [IPS70R2K0CEAKMA1](#) [SQM120N06-3M5L-GE3](#) [TK31J60W5,S1VQ\(O](#) [TK31J60W,S1VQ\(O](#) [TK16J60W,S1VQ\(O](#)
[2SK2614\(TE16L1,Q\)](#) [DMN1017UCP3-7](#) [EFC2J004NUZTDG](#) [P85W28HP2F-7071](#) [NTE2384](#) [DMC2700UDMQ-7](#) [DMN2080UCB4-7](#)
[DMN61D9UWQ-13](#) [US6M2GTR](#) [DMN31D5UDJ-7](#) [DMP22D4UFO-7B](#) [IPS60R3K4CEAKMA1](#) [DMN1006UCA6-7](#) [DMN16M9UCA6-7](#)
[STF5N65M6](#) [IRF40H233XTMA1](#) [STU5N65M6](#) [DMN6022SSD-13](#) [DMN13M9UCA6-7](#) [DMTH10H4M6SPS-13](#) [IPS60R360PFD7SAKMA1](#)
[DMN2990UFB-7B](#) [SSM3K35CT,L3F](#) [IPLK60R1K0PFD7ATMA1](#) [2N7002W-G](#) [MCAC30N06Y-TP](#) [IPWS65R035CFD7AXKSA1](#)
[MCQ7328-TP](#) [SSM3J143TU,LXHF](#) [PJMF280N65E1_T0_00201](#) [PJMF380N65E1_T0_00201](#) [PJMF280N60E1_T0_00201](#)
[PJMF600N65E1_T0_00201](#) [PJMF900N65E1_T0_00201](#) [PJMF900N60E1_T0_00201](#)