

## GENERAL FEATURES

- $V_{DS} = -60V$   $I_D = -3.8A$
- $R_{DS(ON)} < -98m\Omega$  @  $V_{GS}=10V$
- $R_{DS(ON)} < -145m\Omega$  @  $V_{GS}=4.5V$

## Application

- Load/Power Switching
- Interfacing Switching
- Logic Level Shift

## Package and Pin Configuration

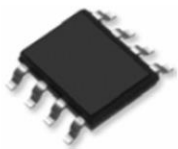

SOP-8 top view

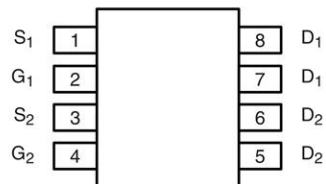

## Marking:

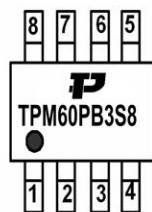

## Circuit diagram

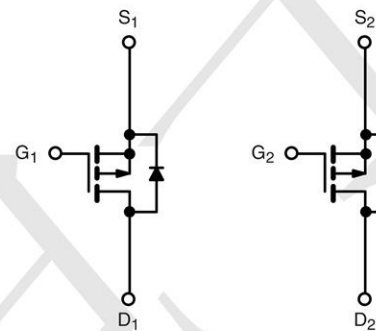

## Absolute Maximum Ratings ( $T_A=25^\circ C$ unless otherwise noted)

Parameter	Symbol	Value	Unit
Drain-Source Voltage	$V_{DSS}$	-60	V
Continuous Drain Current	$I_D$	-3.8	A
Pulsed Drain Current (note1)	$I_{DM}$	-16	A
Gate-Source Voltage	$V_{GSS}$	$\pm 20$	V
Single Pulse Avalanche Energy (note2)	$E_{AS}$	36	mJ
Avalanche Current	$I_{AS}$	12	A
Power Dissipation ( $T_C = 25^\circ C$ ) (note3)	$P_D$	2.3	W
Operating Junction and Storage Temperature Range	$T_J, T_{stg}$	-55 To 150	$^\circ C$

## Thermal Data

Symbol	Parameter	Value	Unit
Rthj-a	Thermal Resistance Junction-ambient <sup>3</sup>	Max. 40	$^\circ C/W$

**Electrical Characteristics (T<sub>J</sub>=25°C unless otherwise noted)**

Specifications T <sub>J</sub> = 25°C, unless otherwise noted						
Parameter	Symbol	Test Conditions	Value			Unit
			Min.	Typ.	Max.	
<b>Static</b>						
Drain-Source Breakdown Voltage	V <sub>(BR)DSS</sub>	V <sub>GS</sub> = 0V, I <sub>D</sub> = -250μA	-60	--	--	V
Zero Gate Voltage Drain Current	I <sub>DSS</sub>	V <sub>DS</sub> = -60V, V <sub>GS</sub> = 0V, T <sub>J</sub> = 25°C	--	--	-1	μA
		V <sub>DS</sub> = -60V, V <sub>GS</sub> = 0V, T <sub>J</sub> = 150°C	--	--	-100	
Gate-Source Leakage	I <sub>GSS</sub>	V <sub>GS</sub> = ±20V	--	--	±100	nA
Gate-Source Threshold Voltage	V <sub>GS(th)</sub>	V <sub>DS</sub> = V <sub>GS</sub> , I <sub>D</sub> = -250μA	-1.0	-1.7	-3.0	V
Drain-Source On-Resistance (Note3)	R <sub>DS(on)</sub>	V <sub>GS</sub> = -10V, I <sub>D</sub> = -4A	--	90	98	mΩ
		V <sub>GS</sub> = -4.5V, I <sub>D</sub> = -3A	--	100	145	mΩ
<b>Dynamic</b>						
Input Capacitance	C <sub>iss</sub>	V <sub>GS</sub> = 0V, V <sub>DS</sub> = -30V, f = 1.0MHz	--	976	--	pF
Output Capacitance	C <sub>oss</sub>		--	70	--	
Reverse Transfer Capacitance	C <sub>rss</sub>		--	30	--	
Total Gate Charge	Q <sub>g</sub>	V <sub>DD</sub> = -30V, I <sub>D</sub> = -4A, V <sub>GS</sub> = -10V	--	24	--	nC
Gate-Source Charge	Q <sub>gs</sub>		--	2.2	--	
Gate-Drain Charge	Q <sub>gd</sub>		--	3.6	--	
Turn-on Delay Time	t <sub>d(on)</sub>	V <sub>DD</sub> = -30V, I <sub>D</sub> = -4A, R <sub>G</sub> = 2.5Ω	--	10	--	ns
Turn-on Rise Time	t <sub>r</sub>		--	5	--	
Turn-off Delay Time	t <sub>d(off)</sub>		--	35	--	
Turn-off Fall Time	t <sub>f</sub>		--	9	--	
<b>Drain-Source Body Diode Characteristics</b>						
Continuous Body Diode Current	I <sub>S</sub>	T <sub>C</sub> = 25°C	--	--	-3.8	A
Pulsed Diode Forward Current	I <sub>SM</sub>		--	--	-16	
Body Diode Voltage	V <sub>SD</sub>	T <sub>J</sub> = 25°C, I <sub>SD</sub> = -4A, V <sub>GS</sub> = 0V	--	--	-1.2	V
Reverse Recovery Time	t <sub>rr</sub>	I <sub>F</sub> = -4A, di <sub>F</sub> /dt = 100A/μs	--	36	--	ns
Reverse Recovery Charge	Q <sub>rr</sub>		--	38	--	nC

Typical Electrical and Thermal Characteristics

Figure 1. Output Characteristics

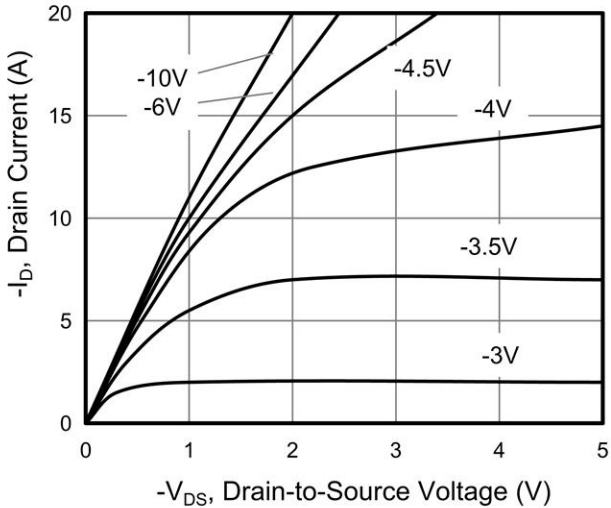

Figure 2. Transfer Characteristics

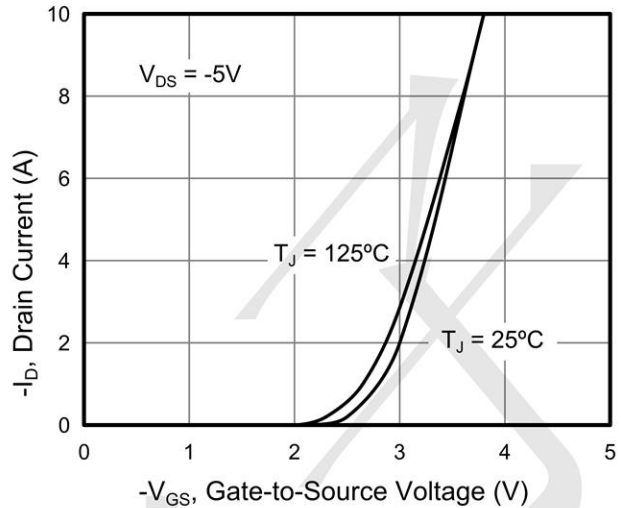

Figure 3. On-Resistance vs. Drain Current

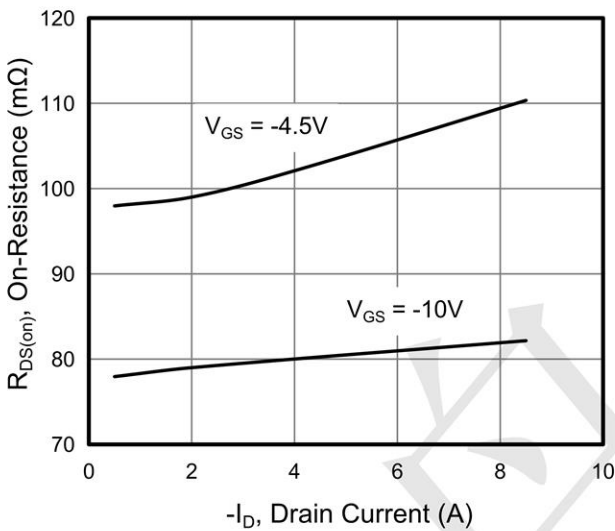

Figure 4. On-Resistance vs. Junction Temperature

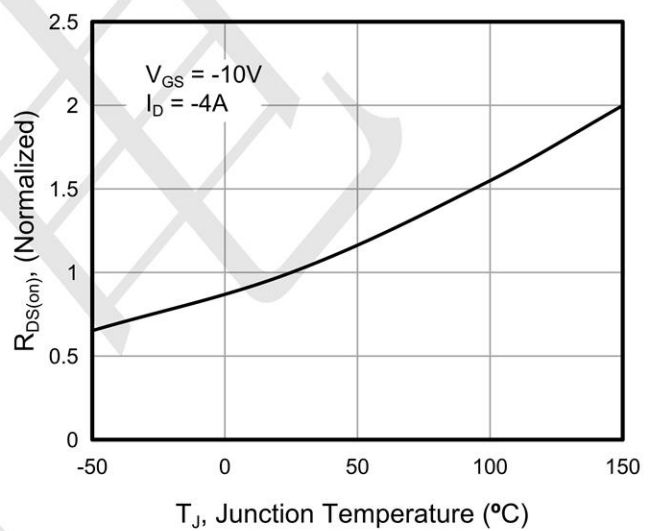

Figure 5. Threshold Voltage vs. Junction Temperature

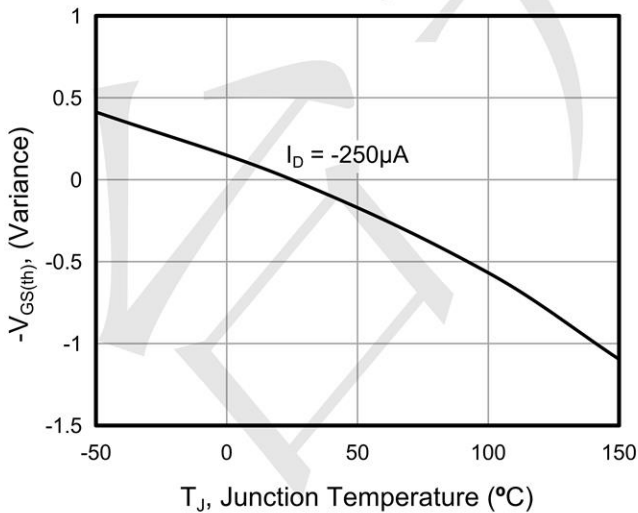
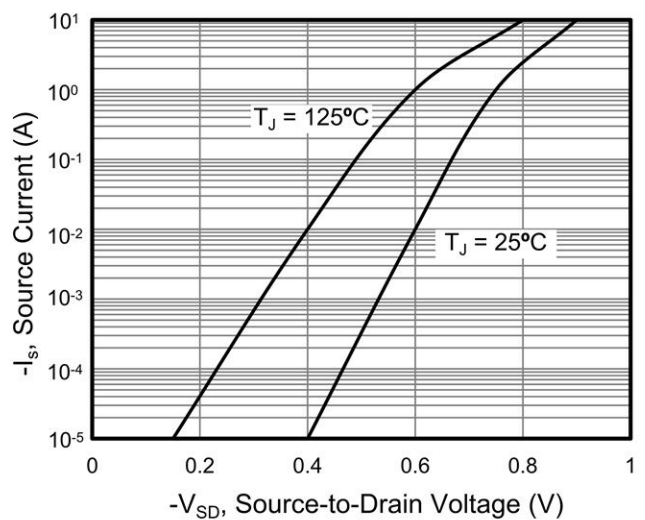
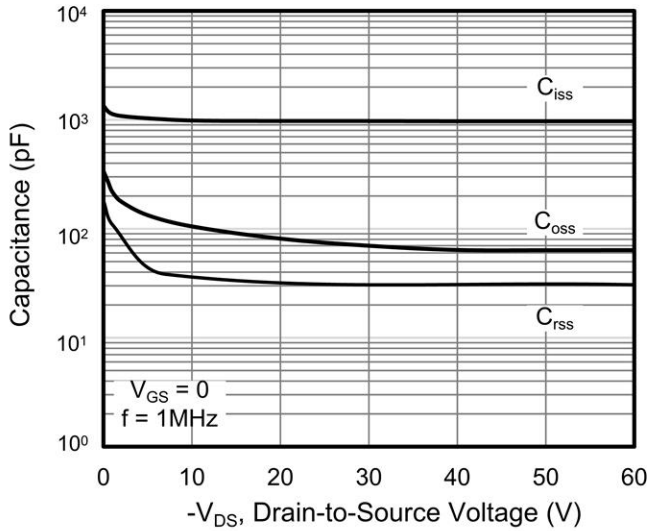

Figure 6. Body Diode Forward Voltage



**Figure 7. Capacitance**



**Figure 8. Gate Charge**

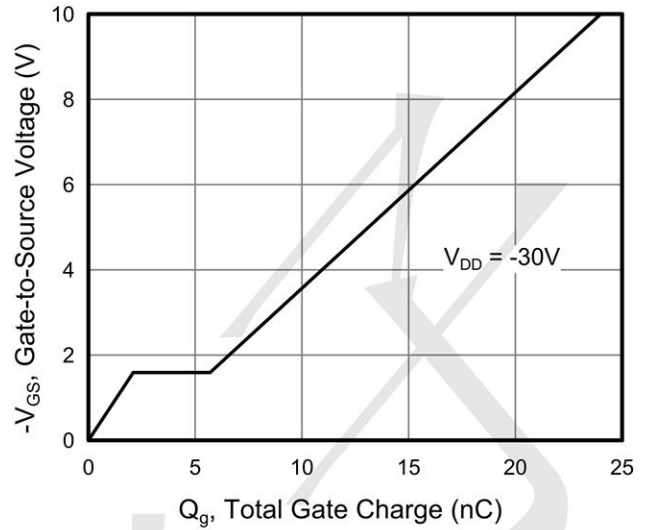

**Figure 9. Transient Thermal Impedance**

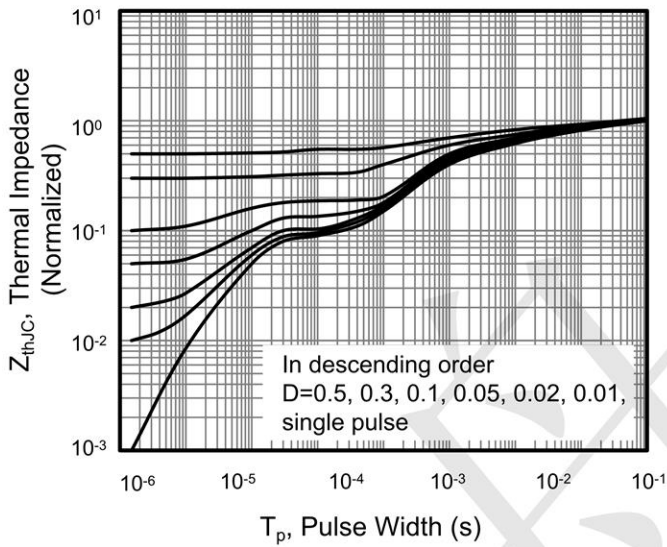

**Figure 10. Safe Operating Area**

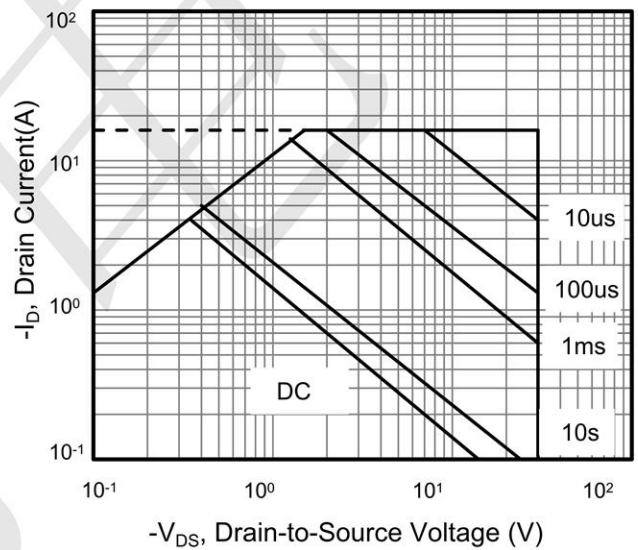

**SOP-8 Package Information**

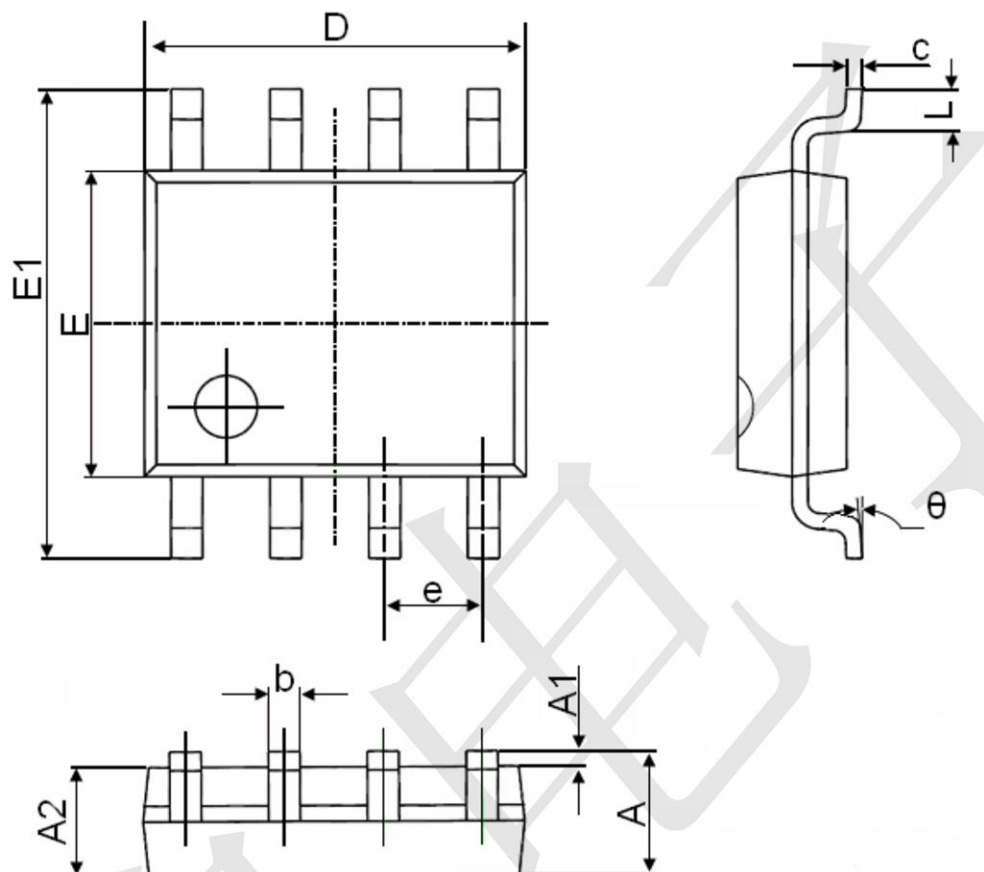

Symbol	Dimensions In Millimeters		Dimensions In Inches	
	Min.	Max.	Min.	Max.
A	1.350	1.750	0.053	0.069
A1	0.100	0.250	0.004	0.010
A2	1.350	1.550	0.053	0.061
b	0.330	0.510	0.013	0.020
c	0.170	0.250	0.006	0.010
D	4.700	5.100	0.185	0.200
E	3.800	4.000	0.150	0.157
E1	5.800	6.200	0.228	0.244
e	1.270(BSC)		0.050(BSC)	
L	0.400	1.270	0.016	0.050
θ	0°	8°	0°	8°

## X-ON Electronics

Largest Supplier of Electrical and Electronic Components

*Click to view similar products for [MOSFET](#) category:*

*Click to view products by [TECH PUBLIC](#) manufacturer:*

Other Similar products are found below :

[IRFD120](#) [JANTX2N5237](#) [2SK2267\(Q\)](#) [BUK455-60A/B](#) [TK100A10N1,S4X\(S](#) [MIC4420CM-TR](#) [VN1206L](#) [NDP4060](#) [SI4482DY](#)  
[IRS2092STRPBF-EL](#) [IPS70R2K0CEAKMA1](#) [TK31J60W5,S1VQ\(O](#) [TK31J60W,S1VQ\(O](#) [TK16J60W,S1VQ\(O](#) [2SK2614\(TE16L1,Q\)](#)  
[DMN1017UCP3-7](#) [EFC2J004NUZTDG](#) [P85W28HP2F-7071](#) [DMN1053UCP4-7](#) [NTE2384](#) [DMC2700UDMQ-7](#) [DMN2080UCB4-7](#)  
[DMN61D9UWQ-13](#) [US6M2GTR](#) [DMN31D5UDJ-7](#) [DMP22D4UFO-7B](#) [IPS60R3K4CEAKMA1](#) [DMN1006UCA6-7](#) [DMN16M9UCA6-7](#)  
[STF5N65M6](#) [IRF40H233XTMA1](#) [STU5N65M6](#) [DMN6022SSD-13](#) [DMN13M9UCA6-7](#) [DMTH10H4M6SPS-13](#) [IPS60R360PFD7SAKMA1](#)  
[DMN2990UFB-7B](#) [SSM3K35CT,L3F](#) [IPLK60R1K0PFD7ATMA1](#) [2N7002W-G](#) [MCAC30N06Y-TP](#) [IPWS65R035CFD7AXKSA1](#)  
[MCQ7328-TP](#) [SSM3J143TU,LXHF](#) [DMN12M3UCA6-7](#) [PJMF280N65E1\\_T0\\_00201](#) [PJMF380N65E1\\_T0\\_00201](#)  
[PJMF280N60E1\\_T0\\_00201](#) [PJMF600N65E1\\_T0\\_00201](#) [PJMF900N65E1\\_T0\\_00201](#)