

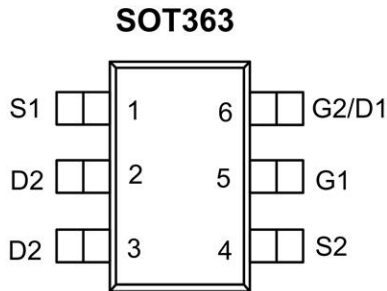
### Product Summary

- Extremely Low RDS(on) P-Channel Load Switch MOSFET
- Low Profile, Small Footprint Package
- VIN Range 1.8 to 8.0 V
- ON/OFF Range 1.5 to 8.0 V
- Level Shift MOSFET is ESD Protected

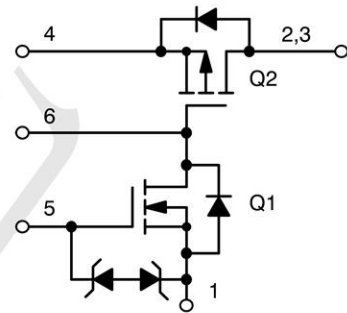
### Application

- Battery Packs
- Battery-Powered Portable Equipment
- Cellular and Cordless Telephones

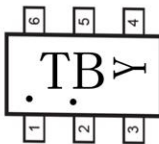
### Package and Pin Configuration



### Circuit diagram



### Marking:



### Absolute Maximum Ratings (TA=25°C unless otherwise noted)

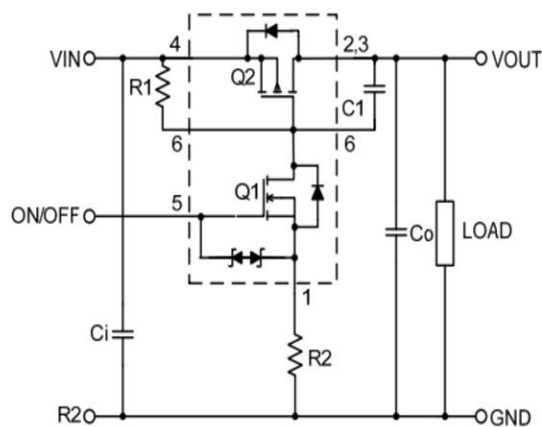
PARAMETER	SYMBOL	Ratings	UNITS
Input Voltage Range	V <sub>IN</sub>	8	V
On/Off Voltage Range	V <sub>ON</sub> /V <sub>OFF</sub>	8	V
Continuous Load Current	I <sub>L</sub>	1.3	A
Pulsed Load Current	I <sub>LM</sub>	3.9	A
Continuous intrinsic diode conduction	I <sub>S</sub>	-0.4	A
Maximum power dissipation	P <sub>D</sub>	1.0	W
Operating Junction and Storage Temperature Range	T <sub>J</sub> , T <sub>STG</sub>	-55~150	°C
ESD, MIL-STD-883D HBM (100pF/1.5kohm) (Von/off pin)	V <sub>ESD</sub>	2	kV
Typical Junction to Ambient <sup>(Note 2)</sup>	R <sub>θJA</sub>	320	°C/W

**Electrical Characteristics (  $T_A = 25^\circ\text{C}$  unless otherwise noted )**

PARAMETER	SYMBOL	TEST CONDITION	MIN.	TYP.	MAX.	UNITS
<b>Off Characteristics</b>						
Q1 Drain-to-Source Breakdown Voltage	$V_{in}$	$V_{GS2}=0V, I_{D2} = -250 \mu A$			-8	V
Leakage Current	$I_{FL}$	$V_{GS1}=0V, V_{DS2} = -8V$	-	-	1	$\mu A$
Q1 Gate-to-Source Leakage Current	$I_{GSS}$	$V_{DS1}=0V, V_{gs1} = 8V$	-	-	1	$\mu A$
Q1 Diode Forward Voltage	$V_{SD}$	$I_S=-0.4A, V_{DS1}=0V$		-0.8	-1.1	V
<b>On Characteristics</b>						
Input voltage range	$V_{ON/OFF}$		1.5			V
Q1 Gate Threshold Voltage	$V_{gs(th)}$	$V_{GS1} = V_{ds1}, I_D = -250 \mu A$	0.4		1.0	V
Input Voltage	$V_{in}$	$V_{GS1} = V_{ds1}, I_D = -250 \mu A$	1.8		8	V
Drain-Source On-State Resistance (Q2)	$R_{DS(on)}$	$V_{ON/OFF} = 1.5V, V_{IN} = 4.5V, I_D = 1.2A$		130	150	m $\Omega$
		$V_{ON/OFF} = 1.5V, V_{IN} = 2.5V, I_D = 1A$		160	210	
		$V_{ON/OFF} = 1.5V, V_{IN} = 1.8V, I_D = 0.7A$		220	270	
Load Current	$I_L$	$V_{drop} \leq 0.2V, V_{in}=5.0, V_{on/oFF}=1.5V$	1.0	-		A
		$V_{drop} \leq 0.3V, V_{in}=2.5, V_{on/oFF}=1.5V$	1.0	-		

**Typical Application Circuit**

Q2 Drain-to-



Source Leakage Current

COMPONENTS		
R1	Pull-Up Resistor	Typical 10k $\Omega$ to 1M $\Omega$ *
R2	Optional Slew-Rate Control	Typical 0 to 100k $\Omega$
Co,C1	Output Capacitance	Usually < 1.0 $\mu F$
C1	Optional Slew-Rate Control	Typical 1000pF

## Typical Operating Characteristics

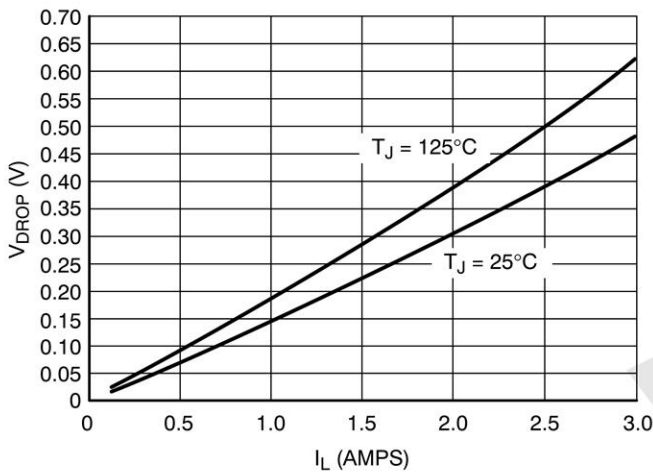


Figure 2.  $V_{drop}$  vs.  $I_L$  @  $V_{in} = 2.5$  V

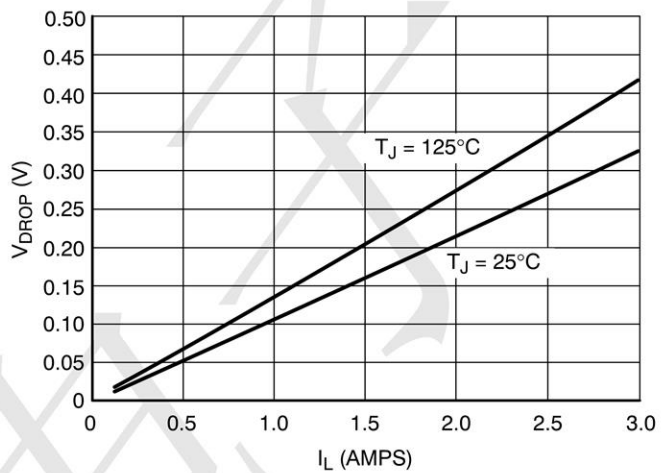


Figure 3.  $V_{drop}$  vs.  $I_L$  @  $V_{in} = 4.5$  V

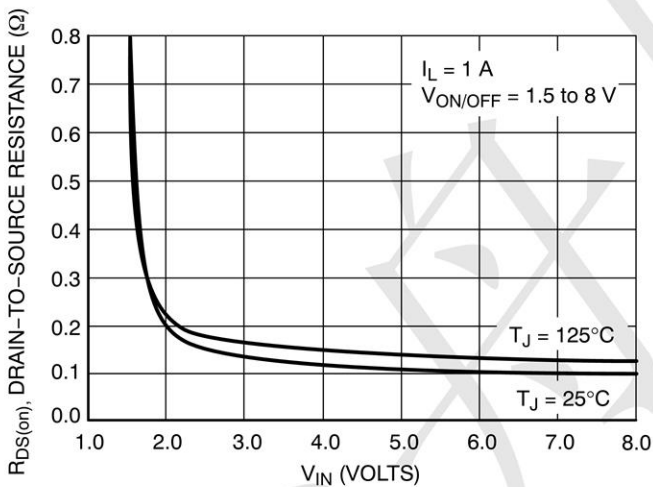


Figure 4. On-Resistance vs. Input Voltage

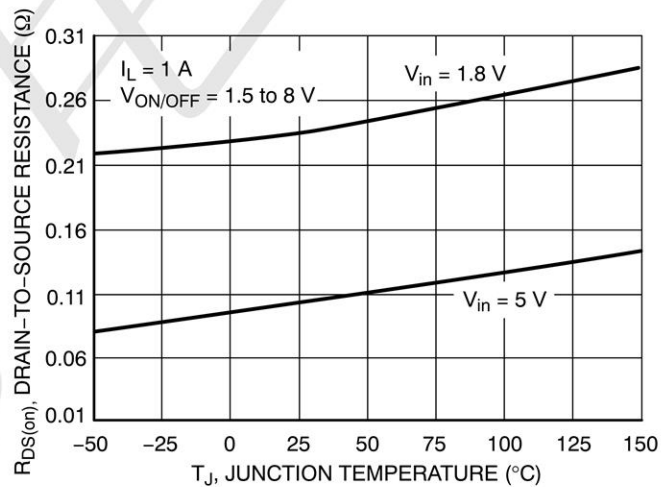


Figure 5. On-Resistance Variation with Temperature

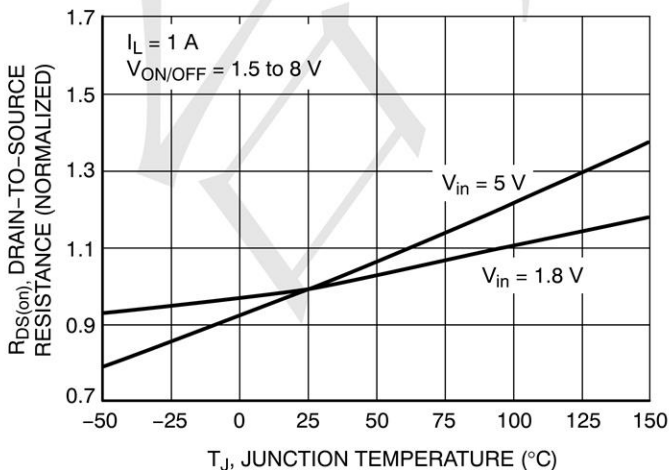


Figure 6. Normalized On-Resistance Variation with Temperature

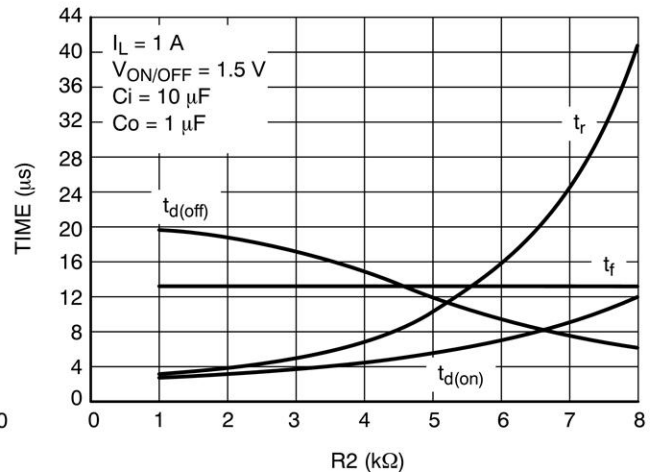
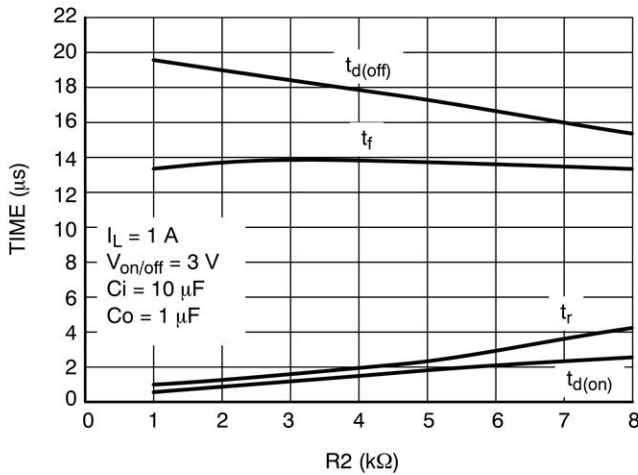
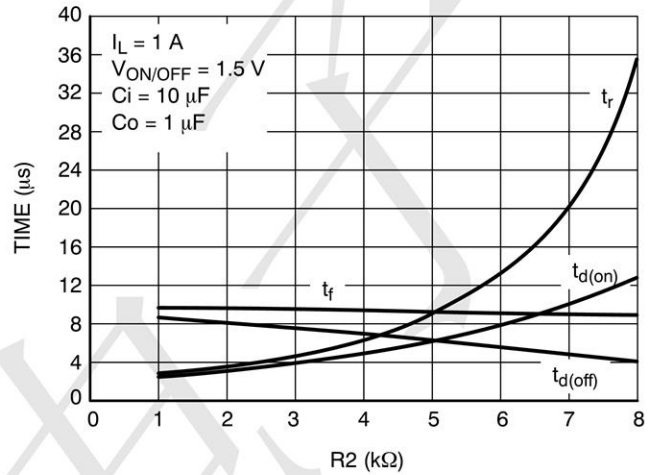


Figure 7. Switching Variation  $R2$  @  $V_{in} = 4.5$  V,  $R1 = 20$  k $\Omega$

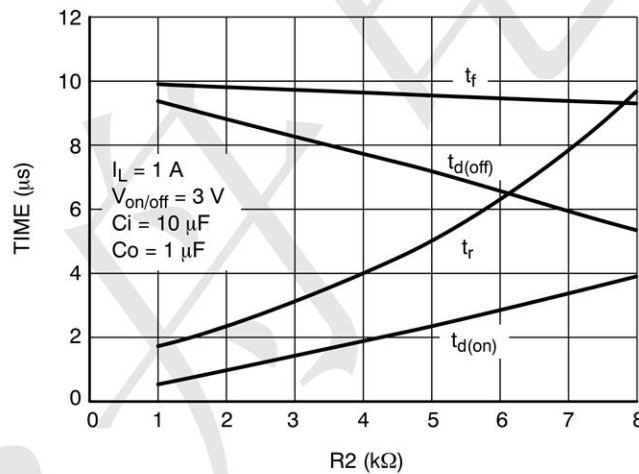
**TYPICAL PERFORMANCE CURVES** ( $T_J = 25^\circ\text{C}$  unless otherwise noted)



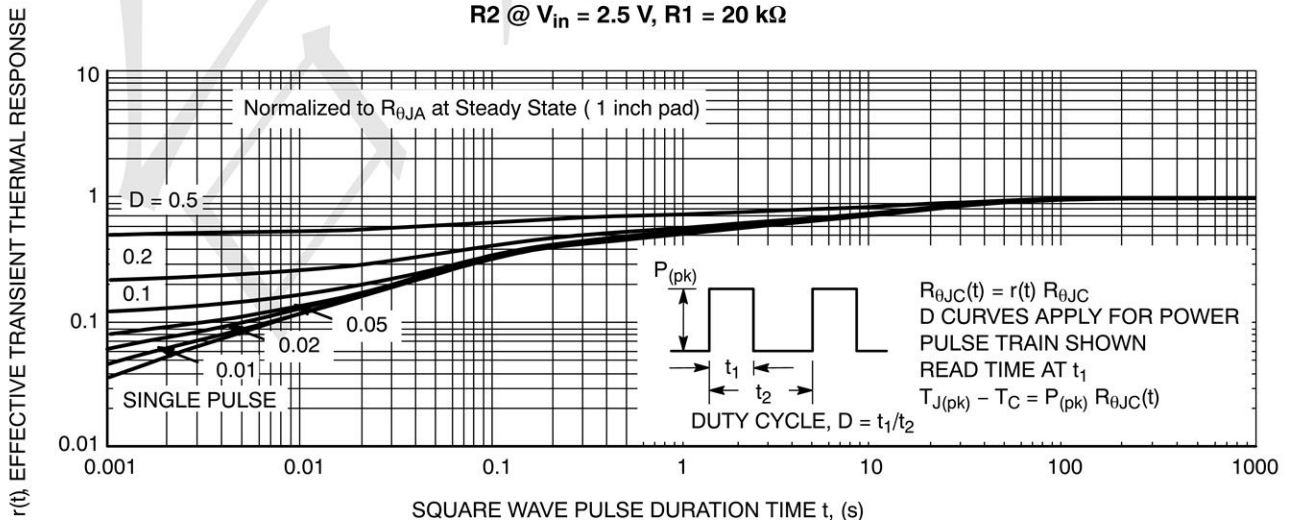
**Figure 8. Switching Variation**  
R2 @  $V_{in} = 4.5\text{ V}$ ,  $R_1 = 20\text{ k}\Omega$



**Figure 9. Switching Variation**  
R2 @  $V_{in} = 2.5\text{ V}$ ,  $R_1 = 20\text{ k}\Omega$

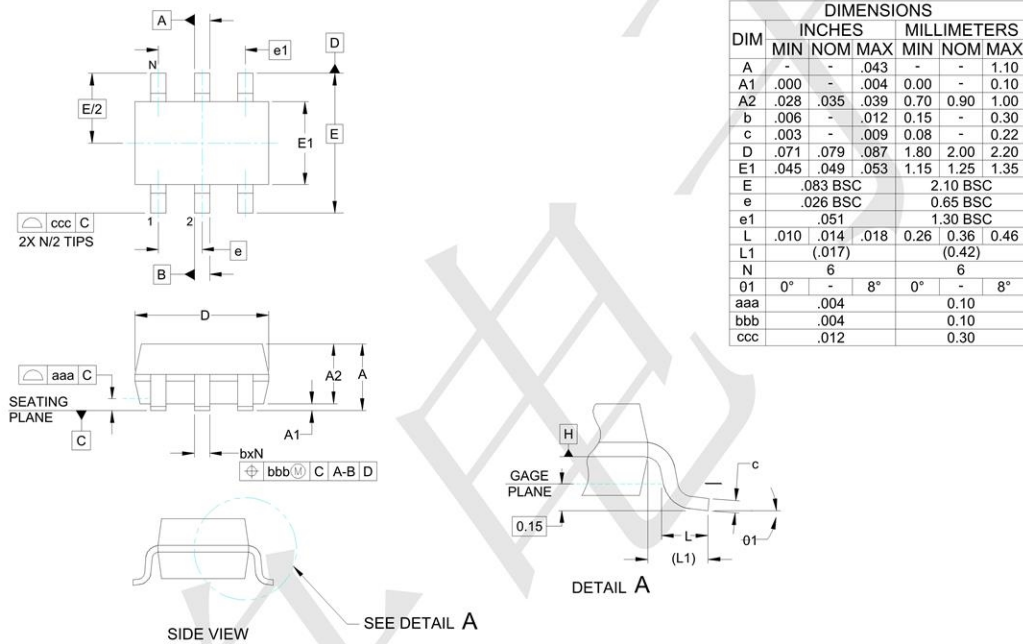


**Figure 10. Switching Variation**  
R2 @  $V_{in} = 2.5\text{ V}$ ,  $R_1 = 20\text{ k}\Omega$

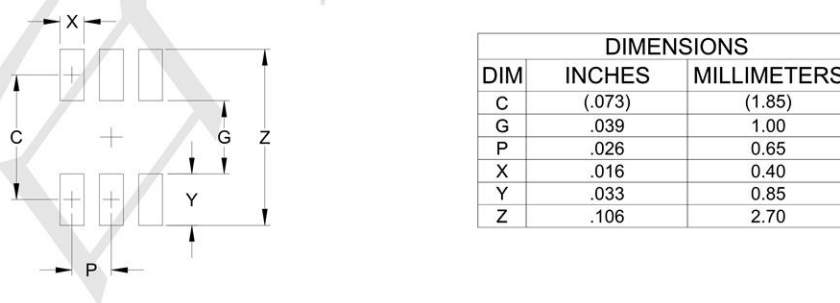


**Figure 11. FET Thermal Response**

**Outline Drawing - SOT-363**



**Land Pattern - SOT-363**



## X-ON Electronics

Largest Supplier of Electrical and Electronic Components

*Click to view similar products for [Power Switch ICs - Power Distribution](#) category:*

*Click to view products by [TECH PUBLIC](#) manufacturer:*

Other Similar products are found below :

[NCP45520IMNTWG-L](#) [TCK111G,LF\(S](#) [FPF1018](#) [DS1222](#) [TCK2065G,LF](#) [SZNCP3712ASNT3G](#) [TLE7244SL](#) [MIC2033-05BYMT-T5](#)  
[MIC2033-12AYMT-T5](#) [MIC2033-05BYM6-T5](#) [AP22811BW5-7](#) [SLG5NT1437VTR](#) [SZNCP3712ASNT1G](#) [DML1008LDS-7](#)  
[KTS1640QGDV-TR](#) [KTS1641QGDV-TR](#) [BTS500101TADATMA2](#) [NCV459MNWTBG](#) [NCP4545IMNTWG-L](#) [NCV8412ASTT1G](#)  
[NCV8412ASTT3G](#) [FPF2260ATMX](#) [SLG5NT1765V](#) [SLG5NT1757V](#) [SLG59M1557VTR](#) [BD2222G-GTR](#) [NCP45780IMN24RTWG](#)  
[NCP45540IMNTWG-L](#) [TPNTJD1155LT1G](#) [FDC6324L-TP](#) [FDC6326L-TP](#) [TPSI1869DH-T1-E3](#) [SI1865DDL](#) [FDC6330L-TP](#) [U6210](#)  
[U25135](#) [U62153](#) [U6513BS](#) [U62133](#) [U6773H](#) [U62143S](#) [U6315BS](#) [U6513B](#) [U6110](#) [SL3405S](#) [BTS7040-2EPA](#) [SY6282ACC](#) [WS3222D-](#)  
[8/TR](#) [DP25136C](#) [DK5V100R20C](#)