

Features

- Fast switching
- Green Device Available
- Suit for 1.5V Gate Drive Applications

Application

- Notebook
- Load Switch
- Networking
- Hand-held Instruments

Package and Pin Configuration

Circuit diagram

SOT363



Top View

Marking:

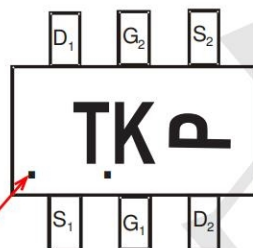

Top View
Pin out

PIN1

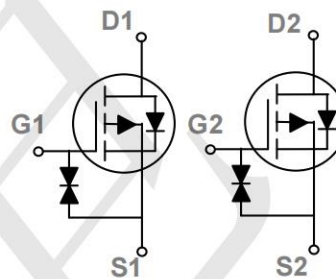

Absolute Maximum Ratings $T_C=25^\circ\text{C}$ unless otherwise noted

Symbol	Parameter	Rating	Units
V_{DS}	Drain-Source Voltage	-20	V
V_{GS}	Gate-Source Voltage	± 12	V
I_D	Drain Current – Continuous ($T_C=25^\circ\text{C}$)	-1.1	A
I_{DM}	Drain Current – Pulsed ¹	-2.2	A
P_D	Power Dissipation ($T_C=25^\circ\text{C}$)	280	mW
	Power Dissipation – Derate above 25°C	2.5	mW/ $^\circ\text{C}$
T_{STG}	Storage Temperature Range	-55 to 150	$^\circ\text{C}$
T_J	Operating Junction Temperature Range	-55 to 150	$^\circ\text{C}$

Thermal Characteristics

Symbol	Parameter	Typ.	Max.	Unit
$R_{\theta JA}$	Thermal Resistance Junction to ambient	---	350	$^\circ\text{C}/\text{W}$

Electrical Characteristics (T_J=25 °C, unless otherwise noted)

Symbol	Parameter	Conditions	Min.	Typ.	Max.	Unit
BV _{DSS}	Drain-Source Breakdown Voltage	V _{GS} =0V, I _D =-250uA	-20	---	---	V
ΔBV _{DSS} /ΔT _J	BV _{DSS} Temperature Coefficient	Reference to 25°C, I _D =-1mA	---	-0.01	---	V/°C
I _{DSS}	Drain-Source Leakage Current	V _{DS} =-20V, V _{GS} =0V, T _J =25°C	---	---	-1	uA
		V _{DS} =-16V, V _{GS} =0V, T _J =125°C	---	---	-10	uA
I _{GSS}	Gate-Source Leakage Current	V _{GS} =±12V, V _{DS} =0V	---	---	±20	uA

On Characteristics

R _{DS(on)}	Static Drain-Source On-Resistance	V _{GS} =-4.5V, I _D =-0.5A	---	400	680	mΩ
		V _{GS} =-2.5V, I _D =-0.5A	---	550		
		V _{GS} =-1.8V, I _D =-0.1A	---	750	1050	
V _{GS(th)}	Gate Threshold Voltage	V _{GS} =V _{DS} , I _D =-250uA	-0.5	-0.7	1.0	V
ΔV _{GS(th)}	V _{GS(th)} Temperature Coefficient		---	3	---	mV/°C

Dynamic and switching Characteristics

Q _g	Total Gate Charge ^{2,3}	V _{DS} =-10V, V _{GS} =-4.5V, I _D =-1A	---	0.5	nC
Q _{gs}	Gate-Source Charge ^{2,3}		---	0.28	
Q _{gd}	Gate-Drain Charge ^{2,3}		---	0.28	
T _{d(on)}	Turn-On Delay Time ^{2,3}	V _{DD} =-10V, V _{GS} =-4.5V, R _G =6Ω I _D =-1A	---	0.4	ns
T _r	Rise Time ^{2,3}		---	0.06	
T _{d(off)}	Turn-Off Delay Time ^{2,3}		---	0.02	
T _f	Fall Time ^{2,3}		---	0.8	
C _{iss}	Input Capacitance	V _{DS} =-10V, V _{GS} =0V, F=1MHz	---	55	pF
C _{oss}	Output Capacitance		---	6	
C _{riss}	Reverse Transfer Capacitance		---	4.5	

Drain-Source Diode Characteristics and Maximum Ratings

Symbol	Parameter	Conditions	Min.	Typ.	Max.	Unit
V _{SD}	Diode Forward Voltage	V _{GS} =0V, I _S =-0.2A, T _J =25°C	---	-0.75	-1.1	V

Characteristic Curves

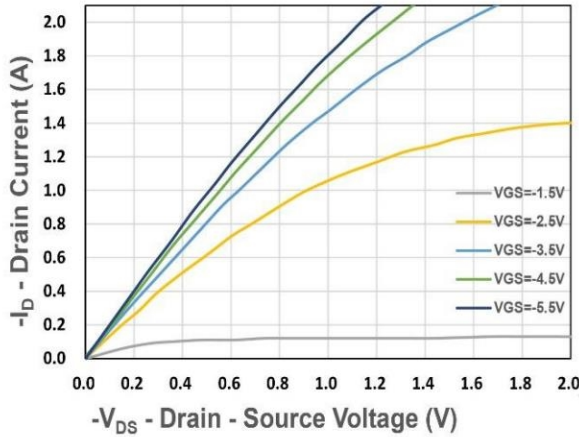

Figure 1. Output Characteristics

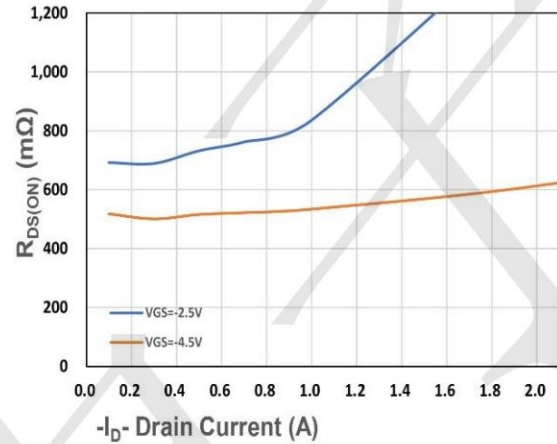

Figure 2. On-Resistance vs. I_D

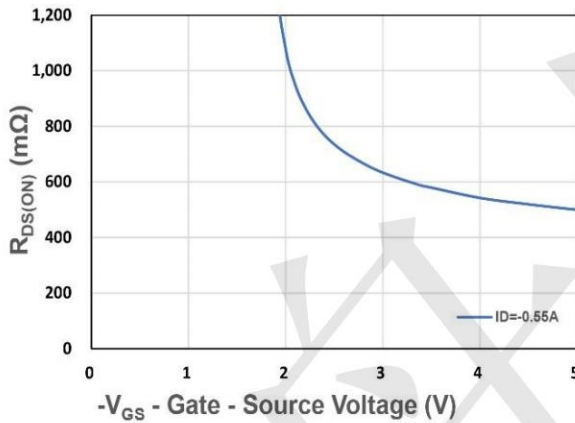

Figure 3. On-Resistance vs. V_{GS}

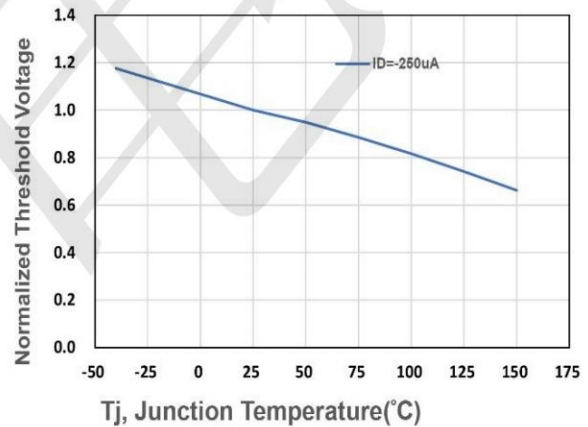

Figure 4. Gate Threshold Voltage

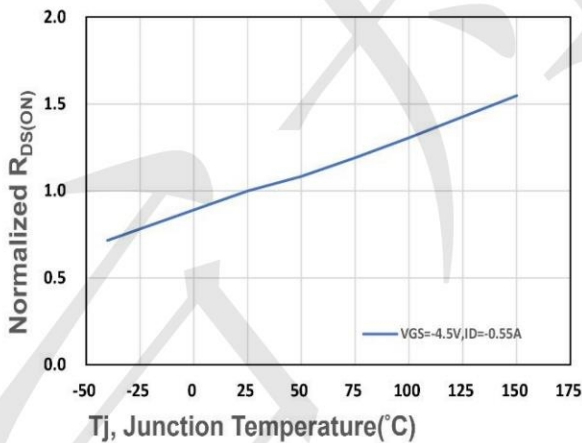

Figure 5. Drain-Source On Resistance

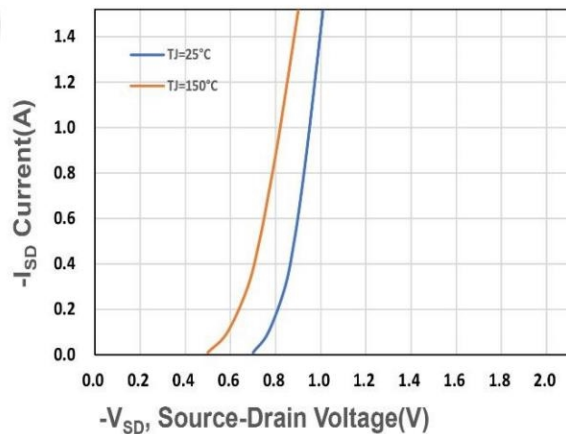

Figure 6. Source-Drain Diode Forward

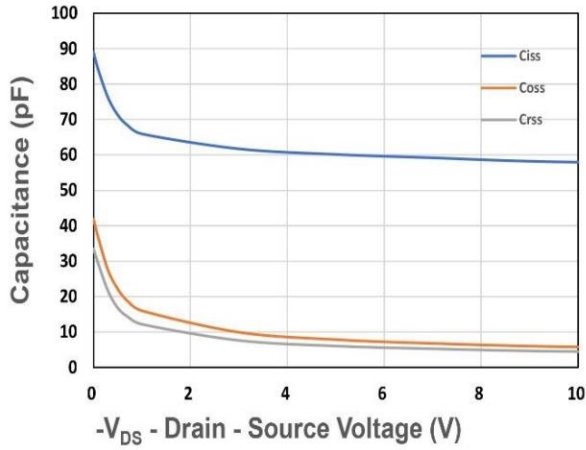

Figure 7. Capacitance

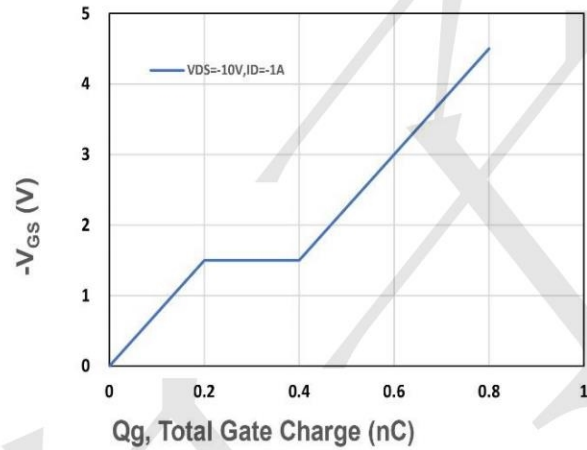

Figure 8. Gate Charge Characteristics

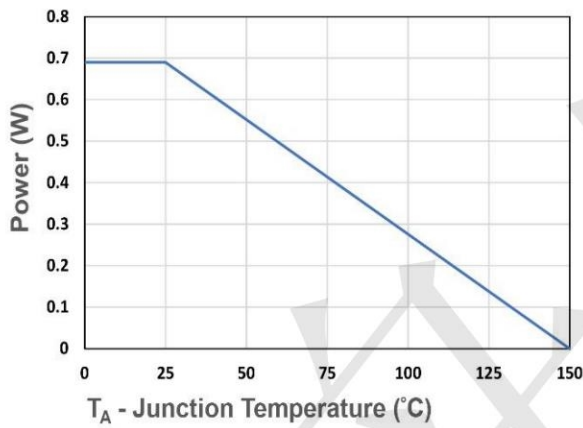

Figure 9. Power Dissipation

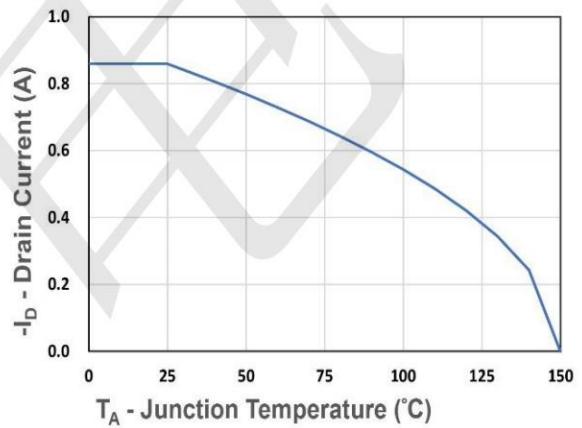

Figure 10. Drain Current

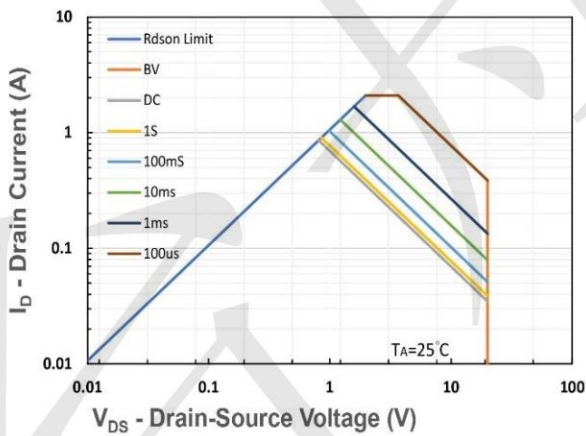

Figure 11. Safe Operating Area

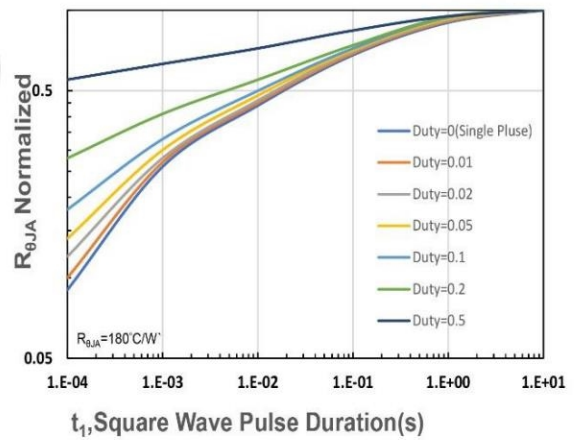
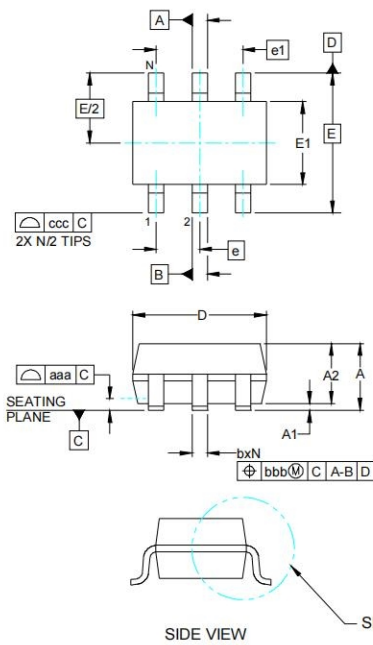
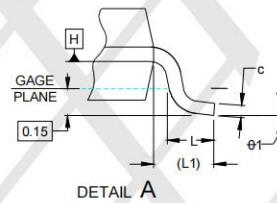

Figure 12. $R_{\theta JA}$ Transient Thermal Impedance

Outline Drawing - SOT-363(2.0X2.1)



DIM	INCHES			MILLIMETERS		
	MIN	NOM	MAX	MIN	NOM	MAX
A	-	-	.043	-	-	1.10
A1	.000	-	.004	0.00	-	0.10
A2	.028	.035	.039	0.70	0.90	1.00
b	.006	-	.012	0.15	-	0.30
c	.003	-	.009	0.08	-	0.22
D	.071	.079	.087	1.80	2.00	2.20
E1	.045	.049	.053	1.15	1.25	1.35
E	.083 BSC			2.10 BSC		
e	.026 BSC			0.65 BSC		
e1	.051			1.30 BSC		
L	.010	.014	.018	0.26	0.36	0.46
L1	(0.17)			(0.42)		
N	6			6		
$\theta 1$	0°	-	8°	0°	-	8°
aaa	.004			0.10		
bbb	.004			0.10		
ccc	.012			0.30		



Land Pattern - SOT-363

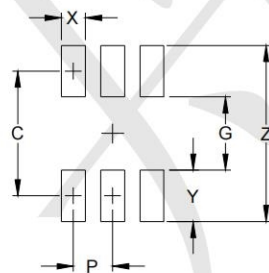

DIM	DIMENSIONS	
	INCHES	MILLIMETERS
C	(.073)	(1.85)
G	.039	1.00
P	.026	0.65
X	.016	0.40
Y	.033	0.85
Z	.106	2.70

SOT-363 Embossed Carrier Tape

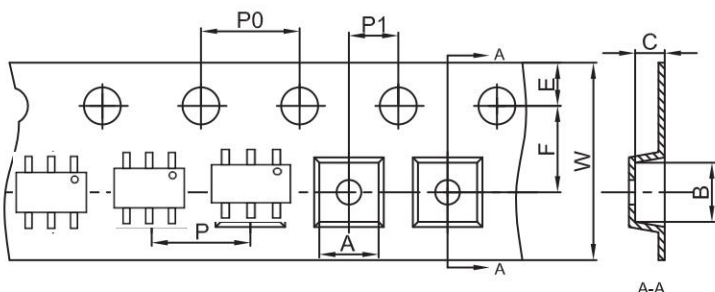

Dimensions are in millimeter										
Pkg type	A	B	C	d	E	F	P0	P	P1	W
SOT-363	2.25	2.55	1.20	Ø1.50	1.75	3.50	4.00	4.00	2.00	8.00

SOT-363 Tape Leader and Trailer

Package orientation in reel

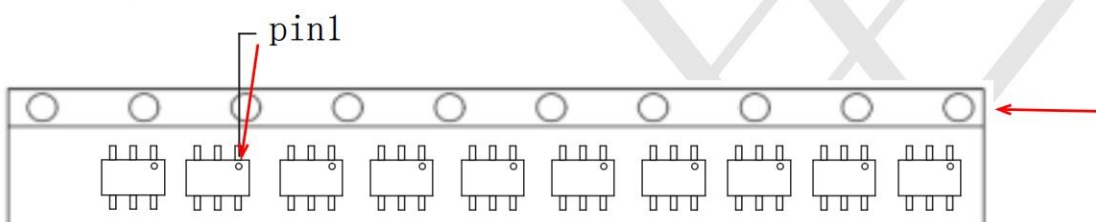

Shipping: 3000 pcs / Tape & Reel

SOT-363 Reel

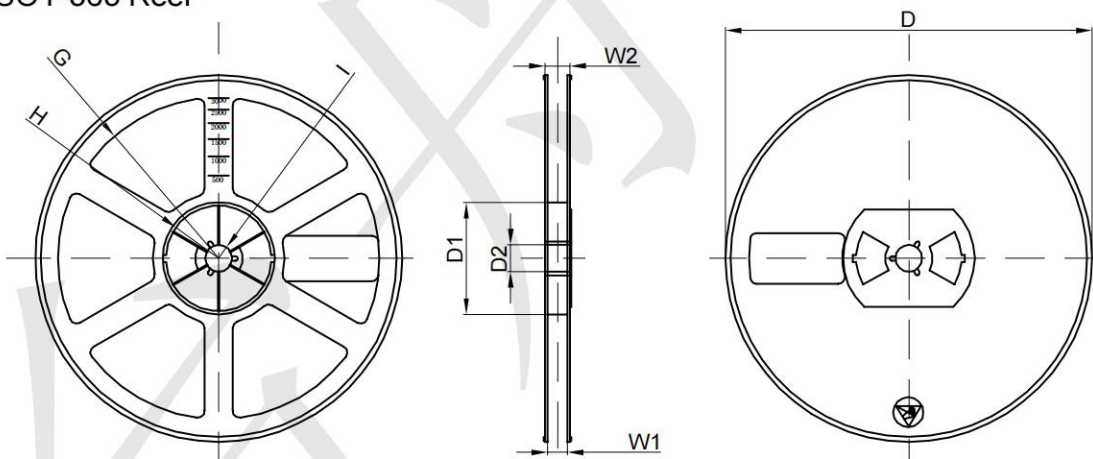

Dimensions are in millimeter								
Reel Option	D	D1	D2	G	H	I	W1	W2
7" Dia	Ø178.00	54.40	13.00	R78.00	R25.60	R6.50	9.50	12.30

REEL	Reel Size	Box	Box Size(mm)	Carton	Carton Size(mm)	G.W.(kg)
3000 pcs	7 Inch	45,000 pcs	203×203×195	180,000 pcs	438×438×220	

X-ON Electronics

Largest Supplier of Electrical and Electronic Components

Click to view similar products for [MOSFET](#) category:

Click to view products by [TECH PUBLIC](#) manufacturer:

Other Similar products are found below :

[614233C](#) [648584F](#) [IRFD120](#) [IRFF430](#) [JANTX2N5237](#) [2N7000](#) [FCA20N60_F109](#) [FDZ595PZ](#) [AOD464](#) [2SK2267\(Q\)](#) [2SK2545\(Q,T\)](#)
[405094E](#) [423220D](#) [MIC4420CM-TR](#) [VN1206L](#) [614234A](#) [715780A](#) [SSM6J414TU,LF\(T](#) [751625C](#) [BSC884N03MS G](#) [BSF024N03LT3 G](#)
[PSMN4R2-30MLD](#) [TK31J60W5,S1VQ\(O](#) [2SK2614\(TE16L1,Q\)](#) [DMN1017UCP3-7](#) [EFC2J004NUZTDG](#) [FCAB21350L1](#) [P85W28HP2F-](#)
[7071](#) [DMN1053UCP4-7](#) [NTE2384](#) [NTE2969](#) [NTE6400A](#) [DMN2080UCB4-7](#) [DMN61D9UWQ-13](#) [US6M2GTR](#) [DMN31D5UDJ-7](#)
[SSM6P54TU,LF](#) [DMP22D4UFO-7B](#) [IPS60R3K4CEAKMA1](#) [DMN1006UCA6-7](#) [DMN16M9UCA6-7](#) [STF5N65M6](#) [STU5N65M6](#)
[C3M0021120D](#) [DMN13M9UCA6-7](#) [BSS340NWH6327XTSA1](#) [MCM3400A-TP](#) [DMTH10H4M6SPS-13](#) [IRF40SC240ARMA1](#)
[IPS60R1K0PFD7SAKMA1](#)