



Features

- u 120 Watts Peak Pulse Power per Line (tp=8/20μs)
- u Protects two or four I/O lines
- u Low capacitance: 0.35 pF typical (I/O to I/O)
- u Low operating voltage: 5V
- u RoHS Compliant
- u IEC61000-4-2 (ESD) ±25kV (air), ±20kV (contact)
- u IEC61000-4-4 (EFT) 40A (5/50ns)
- u IEC61000-4-5 (Lightning) 4A (8/20μs)

Mechanical Characteristics

- u Package: DFN2510-10 (2.5×1.0×0.5mm)
- u Ultra low leakage: nA level
- u Case Material: “Green” Molding Compound.
- u UL Flammability Classification Rating 94V-0
- u Moisture Sensitivity: Level 3 per J-STD-020
- u Terminal Connections: See Diagram Below

Applications

- u High Definition Multimedia Interface (HDMI)
- u Digital Visual Interface (DVI)
- u Unified Display Interface (UDI)
- u MDDI Ports
- u PCI Express
- u Serial ATA

Ordering Information

Part Number	Qty per Reel	Reel Size
TPRCLAMP0524P	3000	7"

Dimensions and Pin Configuration

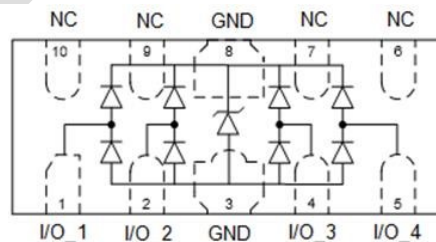

Marking

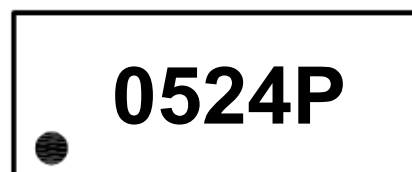

Absolute Maximum Ratings (Tamb=25°C unless otherwise specified)

Parameter	Symbol	Value	Unit
Peak Pulse Power (8/20μs)	Ppk	120	W
Peak Pulse Current (8/20μs)	IPP	4	A
ESD per IEC 61000-4-2 (Air)	VESD	± 25	kV
ESD per IEC 61000-4-2 (Contact)		± 20	
Operating Temperature Range	TJ	-55 to +125	°C
Storage Temperature Range	Tstg	-55 to +150	°C

Electrical Characteristics (TA=25°C unless otherwise specified)

Parameter	Symbol	Min	Typ	Max	Unit	Test Condition
Reverse Working Voltage	VRWM			5	V	Any I/O pin to ground
Breakdown Voltage	VBR	6		9	V	IT = 1mA, any I/O pin to ground
Reverse Leakage Current	IR			0.2	μA	VRWM = 5V, any I/O pin to ground
Clamping Voltage	VC			9	V	IPP = 1A (8 x 20μs pulse), any I/O pin to ground
Clamping Voltage	VC			25	V	IPP = 4A (8 x 20μs pulse), any I/O pin to ground
Junction Capacitance	CJ		0.35		pF	VR = 0V, f = 1MHz, between I/O pins
Junction Capacitance	CJ		0.6	0.8	pF	VR = 0V, f = 1MHz, any I/O pin to ground

Characteristic Curves

Fig1. 8/20 μ s Pulse Waveform

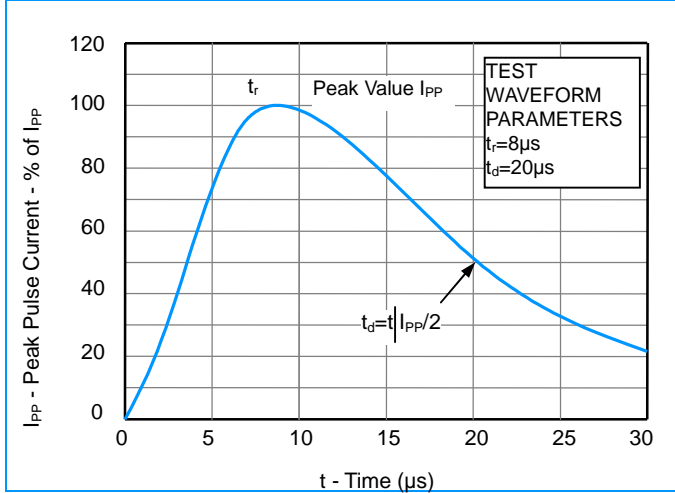

Fig2. ESD Pulse Waveform (according to IEC 61000-4-2)

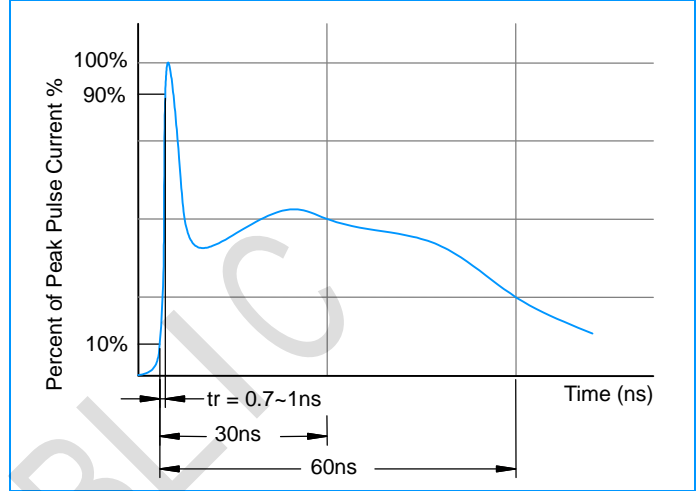

Fig3. Non - Repetitive Peak Pulse Power vs. Pulse Time

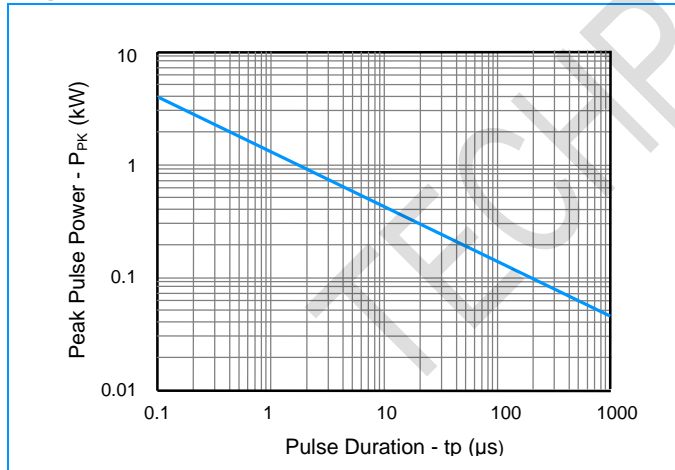
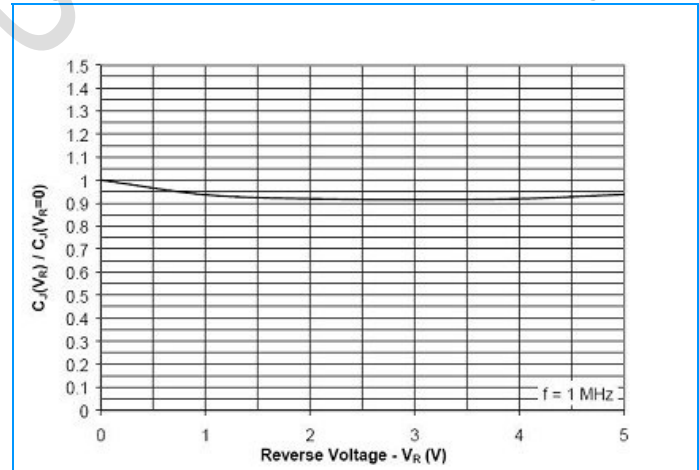
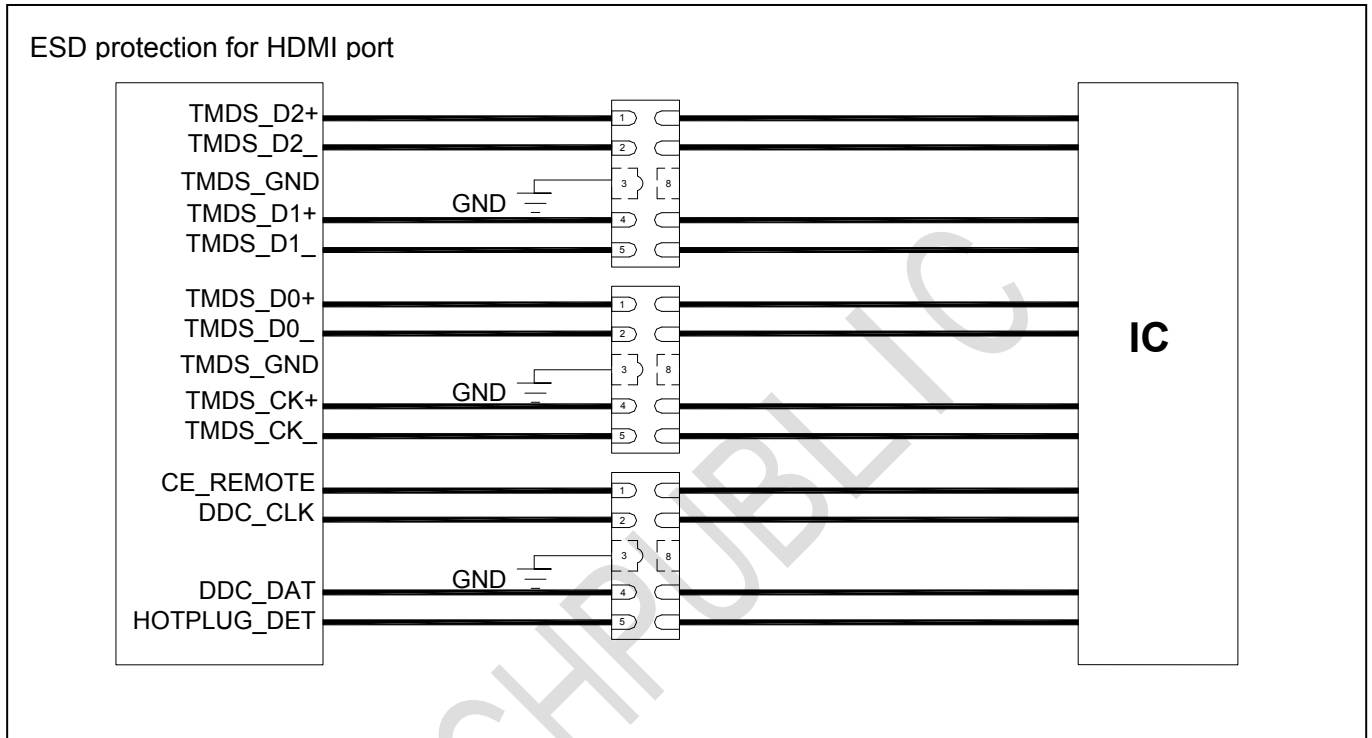

Fig4. Normalized Capacitance vs. Reverse Voltage



Application Information



Outline Drawing - DFN2510-10

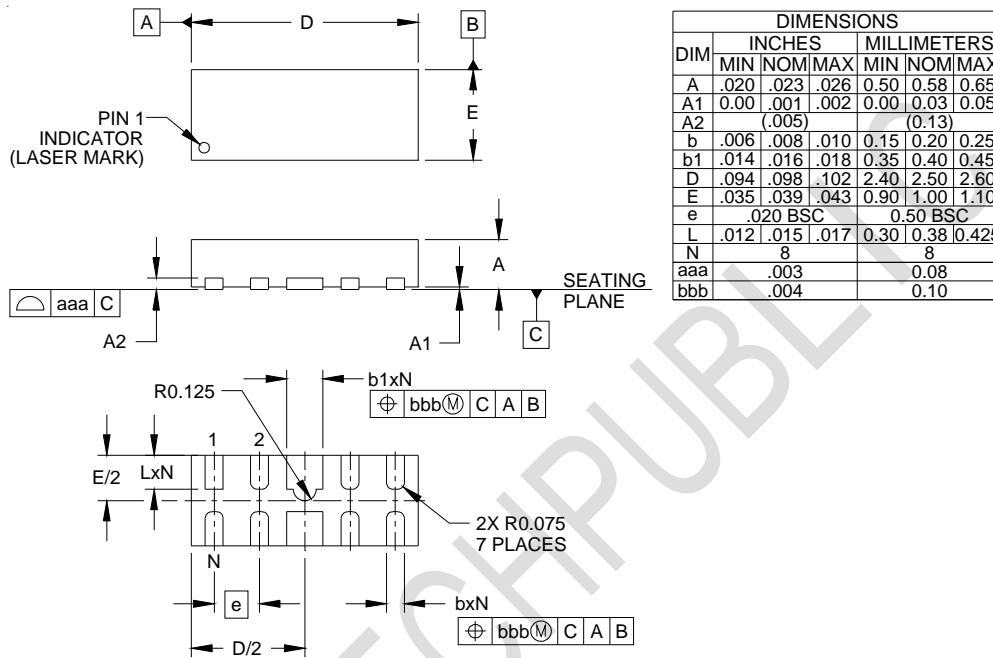

Land Pattern - DFN2510-10

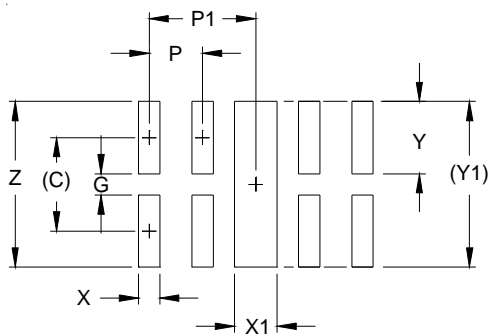

DIM	DIMENSIONS	
	INCHES	MILLIMETERS
C	(.034)	(0.875)
G	.008	0.20
P	.020	0.50
P1	.039	1.00
X	.008	0.20
X1	.016	0.40
Y	.027	0.675
Y1	(.061)	(1.55)
Z	.061	1.55

X-ON Electronics

Largest Supplier of Electrical and Electronic Components

Click to view similar products for [ESD Suppressors / TVS Diodes](#) category:

Click to view products by [TECH PUBLIC](#) manufacturer:

Other Similar products are found below :

[NTE4902](#) [P4SMAJ15A](#) [P4SMAJ26A](#) [SMAJ400CA-TP](#) [TGL34-47CA](#) [ESDAULC45-1BF4](#) [SM1605E3/TR13](#) [SMF20A-TP](#) [P4SMAJ12A](#)
[CPDUR24V-HF](#) [CPDQC5V0USP-HF](#) [CPDQC5V0-HF](#) [MPLAD30KP45CAE3](#) [MMBZ27VCLQ-7-F](#) [MMAD1108/TR13](#) [MPLAD30KP24A](#)
[ACPDQC5V0R-HF](#) [DFLT170A-7](#) [NTE4900](#) [NTE4926](#) [NTE4938](#) [SMF22A-TP](#) [SMF12A-TP](#) [SLVU2.8-TP](#) [SMLJ6.5CA-TP](#) [SMAJ6.5CA-](#)
[TP](#) [MMAD1108E3/TR13](#) [D5V0M1U2LP3-7](#) [SMAJ400A-TP](#) [AOZ8811DT-03](#) [AOZ8831DI-05](#) [AOZ8831DT-03](#) [SMAJ188CA](#) [3SMC33CA](#)
[BK](#) [CPDQC3V3C-HF](#) [CPDQC12VE-HF](#) [MPLAD30KP170CA](#) [82357120100](#) [5.0SMLJ15CA-TP](#) [5KP18A-TP](#) [P6KE8.2A-TP](#)
[MPLAD30KP43CAE3](#) [SMAJ43A-TP](#) [D5V0F6U8LP33-7](#) [TVS5501V10MUT5G](#) [5.0SMLJ24CA-TP](#) [SMAJ110CA-TP](#) [MPLAD15KP75CAE3](#)
[MMAD1103e3/TR13](#) [DFLT40AQ-7](#)