

Features

- ◆ Ultra low capacitance: 0.3pF typical (I/O to I/O)
- ◆ Ultra low leakage: nA level
- ◆ Low operating voltage: 3.3V
- ◆ Low clamping voltage
- ◆ Up to 4 data lines and one power line protects
- ◆ Complies with following standards:
 - IEC 61000-4-2 (ESD) immunity test
Air discharge: ±20kV
Contact discharge: ±15kV
 - IEC61000-4-4 (EFT) 40A (5/50ns)
 - IEC61000-4-5 (Lightning) : 4 A(8/20μs)
- ◆ ROHS Compliant

Mechanical Characteristics

- ◆ Package: DFN2510-10 (2.5×1.0×0.5mm)
- ◆ Ultra low leakage: nA level
- ◆ Case Material: “Green” Molding Compound.
- ◆ UL Flammability Classification Rating 94V-0
- ◆ Moisture Sensitivity: Level 3 per J-STD-020
- ◆ Terminal Connections: See Diagram Below

Applications

- ◆ High Definition Multimedia Interface (HDMI)
- ◆ Digital Visual Interface (DVI)
- ◆ Unified Display Interface (UDI)
- ◆ MDDI Ports
- ◆ PCI Express
- ◆ Serial ATA

Ordering Information

Part Number	Qty per Reel	Reel Size
TPRclamp3324P	3000	7"

Dimensions and Pin Configuration

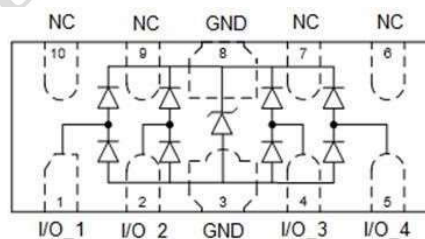

Marking:3324 Or 14***

Absolute Maximum Ratings (Tamb=25°C unless otherwise specified)

Parameter	Symbol	Value	Unit
ESD per IEC 61000-4-2 (Air)	VESD	±20	kV
ESD per IEC 61000-4-2 (Contact)		±15	
Operating Temperature Range	TJ	-55 to +125	°C
Storage Temperature Range	Tstg	-55 to +150	°C

Electrical Characteristics (TA=25°C unless otherwise specified)

Parameter	Symbol	Min	Typ	Max	Unit	Test Condition
Reverse Working Voltage	VRWM			3.3	V	
Breakdown Voltage	VBR	3.6	4	5.5	V	IT = 1mA
Reverse Leakage Current	IR			0.06	µA	VRWM = 3.3V
Clamping Voltage	VC			15	V	I _{PP} = 4A (8 x 20µs pulse) any I/O pin to ground
Junction Capacitance	CJ		0.3	0.4	pF	VR = 0V, f = 1MHz, between I/O pins
Junction Capacitance	CJ			0.8	pF	VR = 0V, f = 1MHz, any I/O pin to ground

Characteristic Curves

Fig1. 8/20 μ s Pulse Waveform

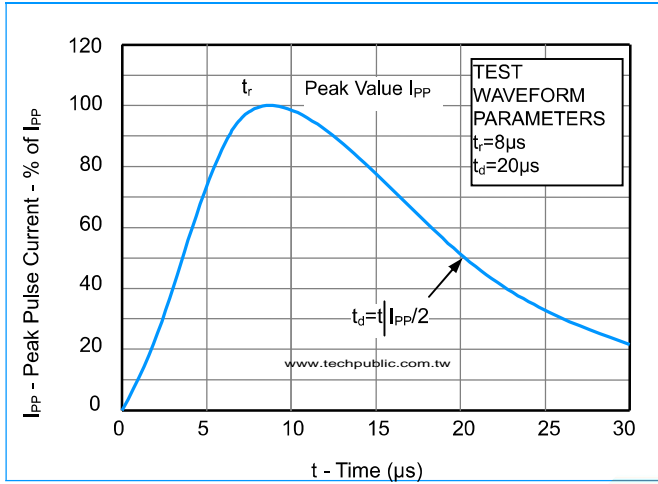

Fig2. ESD Pulse Waveform (according to IEC 61000-4-2)

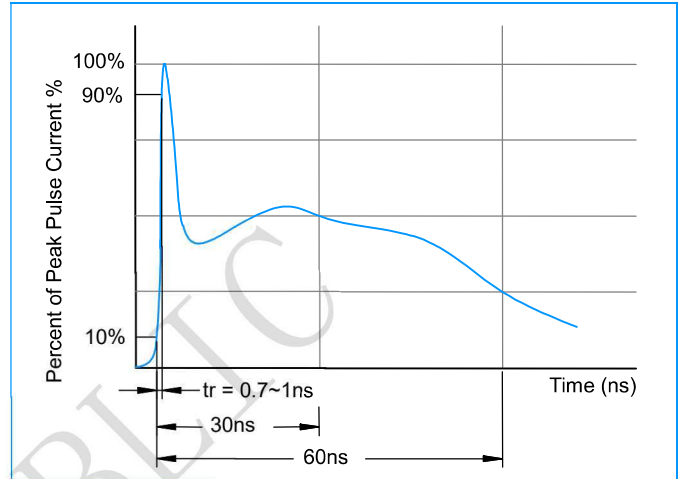
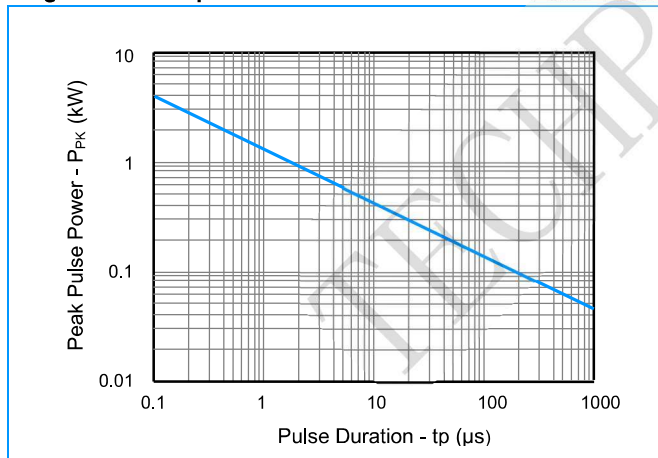
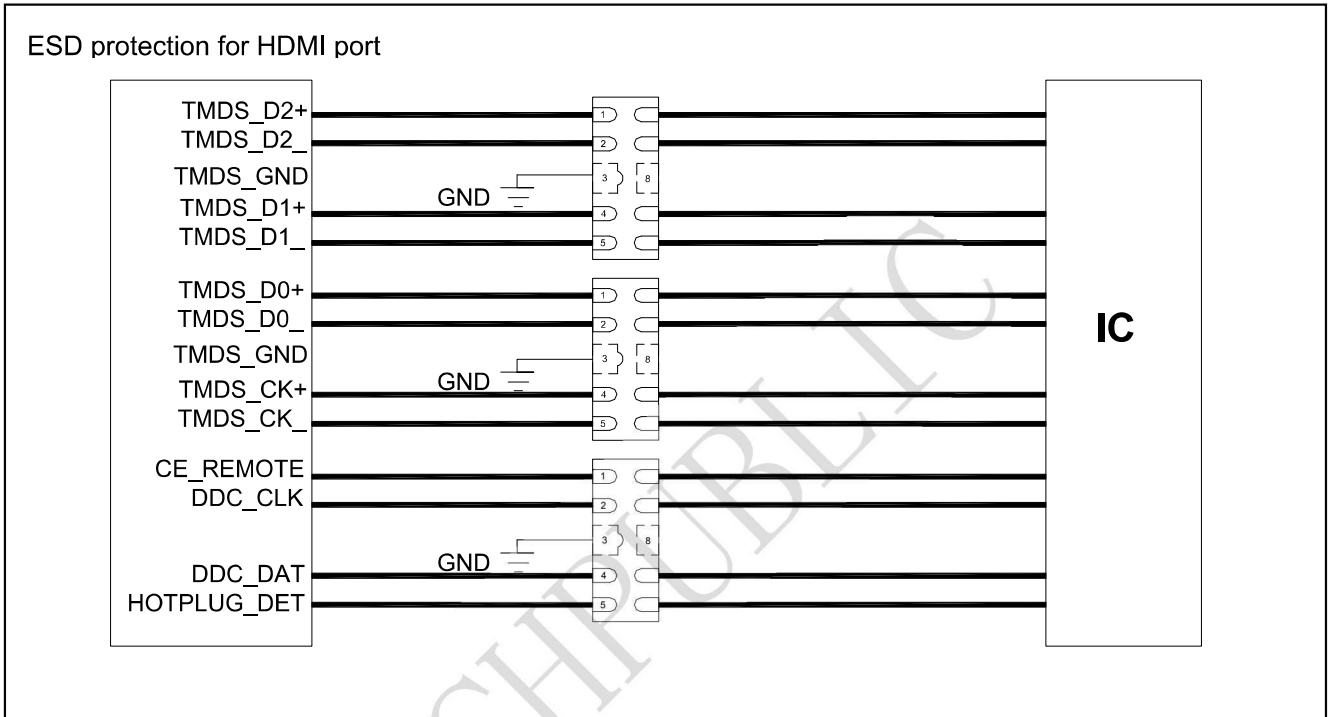

Fig3. Non - Repetitive Peak Pulse Power vs. Pulse Time



Application Information



Outline Drawing - DFN2510-10

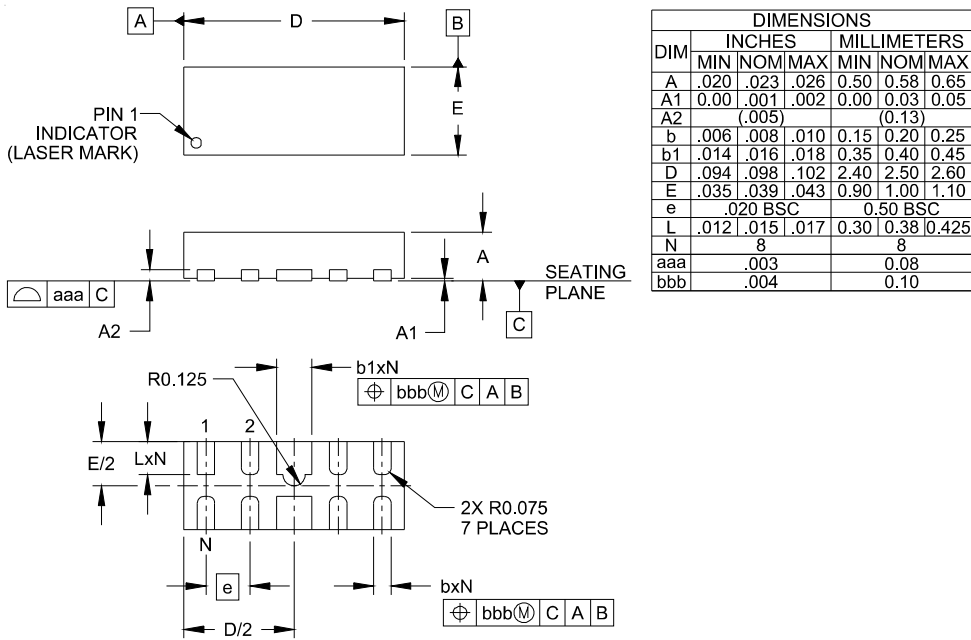

Land Pattern - DFN2510-10

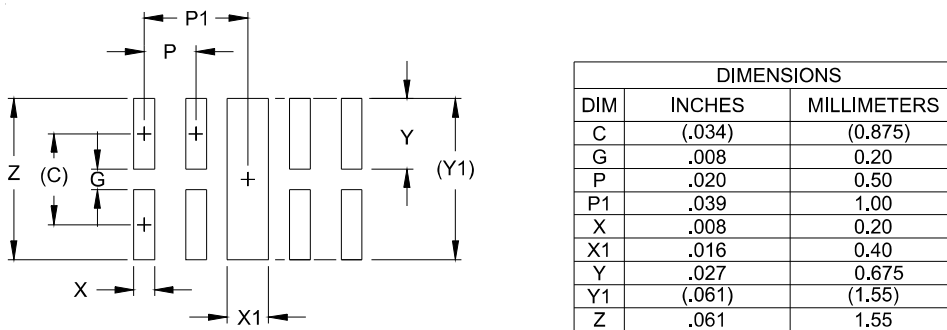

Marking

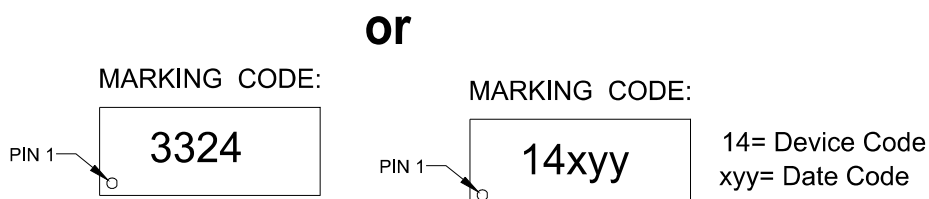

X-ON Electronics

Largest Supplier of Electrical and Electronic Components

Click to view similar products for [ESD Suppressors / TVS Diodes](#) category:

Click to view products by [TECH PUBLIC](#) manufacturer:

Other Similar products are found below :

[60KS200C](#) [D18V0L1B2LP-7B](#) [D5V0F4U5P5-7](#) [DESD5V0U1BB-7](#) [NTE4902](#) [P4KE27CA](#) [P6KE11CA](#) [P6KE39CA-TP](#) [P6KE8.2A](#)
[SA110CA](#) [SA60CA](#) [SA64CA](#) [SMBJ12CATR](#) [SMBJ33CATR](#) [SMBJ8.0A](#) [ESD101-B1-02ELS E6327](#) [ESD105-B1-02EL E6327](#) [ESD112-B1-02EL E6327](#) [ESD119B1W01005E6327XTSA1](#) [ESD5V0L1B02VH6327XTSA1](#) [ESD7451N2T5G](#) [19180-510](#) [CPDT-5V0USP-HF](#)
[3.0SMCJ33CA-F](#) [3.0SMCJ36A-F](#) [HSPC16701B02TP](#) [D3V3Q1B2DLP3-7](#) [D55V0M1B2WS-7](#) [DESD5V0U1BL-7B](#) [DRTR5V0U4SL-7](#)
[SCM1293A-04SO](#) [ESD200-B1-CSP0201 E6327](#) [SM12-7](#) [SMF8.0A-TP](#) [SMLJ45CA-TP](#) [SMQA1000T1G](#) [CEN955 W/DATA](#) [82350120560](#)
[VESD12A1A-HD1-GS08](#) [CPDUR5V0R-HF](#) [CPDQC5V0U-HF](#) [CPDQC5V0USP-HF](#) [CPDQC5V0-HF](#) [IP4042CX5/LF,135](#) [D1213A-01LP4-7B](#) [D1213A-02WL-7](#) [1SMB33CAT3G-XYZ](#) [MMAD1108/TR13](#) [5KP100A](#) [5KP15A](#)