

Features

- 2μA Ground Current at no Load
- ±2% Output Accuracy
- 600mA Output Current
- 10nA Disable Current (by option)
- Wide Operating Input Voltage Range: 1.2V to 5.5V
- Dropout Voltage: 0.32V at 600mA / V_{OUT} 3.3V
- Adjustable Output Voltage
- Stable with Ceramic or Tantalum Capacitor
- Current Limit Protection
- Over-Temperature Protection
- SOT-23-5 Packages Available

Applications

- Portable, Battery Powered Equipment
- Low Power Microcontrollers
- Laptop, Palmtops and PDAs
- Wireless Communication Equipment
- Audio/Video Equipment
- Car Navigation Systems

General Description

The TPRT9080-08 are a group of low-dropout (LDO) voltage regulators offering the benefits of wide input voltage range from 1.2V to 5.5V, low dropout voltage, low power consumption, and miniaturized packaging. Quiescent current of only 2μA makes these devices ideal for powering the battery-powered, always-on systems that require very little idle-state power dissipation to a longer service life. There is an option of

shutdown mode by selecting the parts with the EN pin and pulling it low. The shutdown current in this mode goes down to only 10nA (typical).

The TPRT9080-08 of linear regulators are stable with the ceramic output capacitor over its wide input range from 1.2V to 5.5V and the entire range of output load current (0mA to 600mA).

Ordering Information

TPRT9080N-08GJ5

GJ5:SOT23-5 Package

Output voltage: ADJ
(SNS)VREF=0.8V

PIN CONFIGURATION

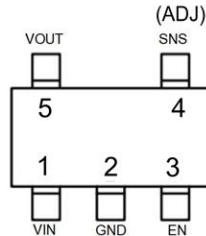

Pin No	Pin Name	Pin Function
2	GND	Ground
5	VOUT	Output of the Regulator
1	VIN	Input of Supply Voltage.
3	EN	Enable Control Input.
4	SNS	Output Feedback Pin

TYPICAL APPLICATION

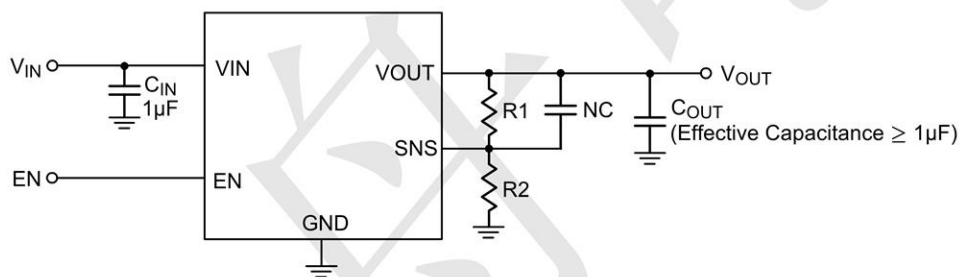
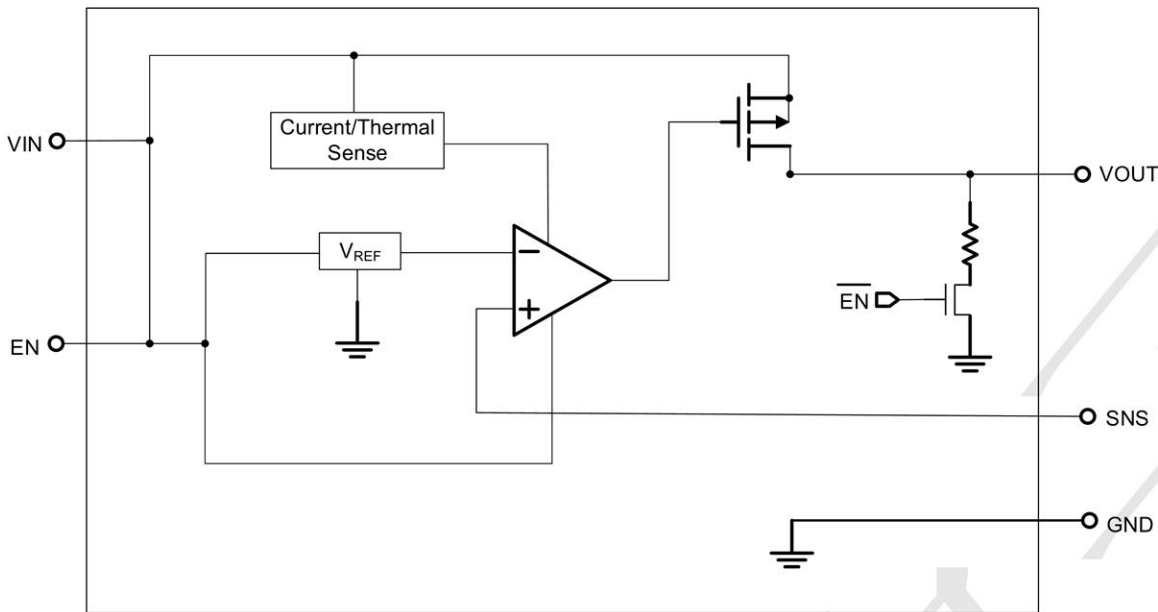

Figure 3. Adjustable Output Voltage Application Circuit

$$R_1 = R_2 \times \left(\frac{V_{OUT}}{0.8V} - 1 \right) \quad \text{where } R_2 < 24K\Omega$$

BLOCK DIAGRAM



Absolute Maximum Rating ($T_A=25^\circ\text{C}$ unless otherwise noted)

VIN to GND	-----	-0.3V to 6.5V
VOUT, EN, SNS to GND	-----	-0.3V to 6V
VOUT to VIN	-----	-6V to 0.3V
Package Thermal Resistance (Note 2)		
SOT-23-5, θ_{JA}	-----	200 $^\circ\text{C} / \text{W}$
Lead Temperature (Soldering, 10 sec.)	-----	260 $^\circ\text{C}$
Junction Temperature	-----	150 $^\circ\text{C}$
Storage Temperature Range	-----	-60 $^\circ\text{C}$ to 150 $^\circ\text{C}$
ESD Susceptibility		
HBM	-----	2KV
MM	-----	200V
CDM	-----	2KV

Recommended Operating Conditions

Input Voltage VIN	-----	1.2V to 5.5V
Junction Temperature Range	-----	-40 $^\circ\text{C}$ to 125 $^\circ\text{C}$
Ambient Temperature Range	-----	-40 $^\circ\text{C}$ to 85 $^\circ\text{C}$

Electrical Characteristics

($V_{IN} = 5V$, $V_{EN} = 5V$ $T_A = 25^\circ C$ unless otherwise specified)

Parameter	Symbol	Test Conditions	Min	Typ	Max	Unit	
Supply Voltage	V_{IN}		1.2	--	5.5	V	
DC Output Voltage Accuracy	V_{SNS}	$I_{LOAD} = 0.1mA$		0.8		V	
SNS Input Current	I_{SNS}	$SNS = V_{OUT}$		0.7		μA	
Dropout Voltage ($I_{LOAD} = 600mA$) (Note 3)	V_{DROP_3V}	$V_{OUT} \geq 3V$		0.32		V	
	$V_{DROP_2.8V}$	$V_{OUT} = 2.8V$		0.36			
	$V_{DROP_2.5V}$	$V_{OUT} = 2.5V$		0.36			
	$V_{DROP_1.8V}$	$V_{OUT} = 1.8V$		0.57			
	$V_{DROP_1.5V}$	$V_{OUT} = 1.5V$		0.71			
	$V_{DROP_1.2V}$	$V_{OUT} = 1.2V$		0.8			
Ground Current	I_Q	$I_{LOAD} = 0mA$		2		μA	
Shutdown Ground Current	I_{SD}	$V_{EN} = 0V$,		0.01	0.5	μA	
V_{OUT} Shutdown Leakage Current	I_{LEAK}	$V_{OUT} = 0V$		0.01	0.5		
Enable Threshold Voltage	V_{IH}	EN Rising			2	V	
	V_{IL}	EN Falling	0.6				
EN Input Current	I_{EN}	$V_{EN} = 5V$		10	100	nA	
Line Regulation	$\Delta LINE$	$I_{LOAD} = 30mA$, $1.5V \leq V_{IN} \leq 5.5V$ or $(V_{OUT} + 0.2V) \leq V_{IN} \leq 5.5V$		0.2		%	
Load Regulation	$\Delta LOAD$	$10mA \leq I_{LOAD} \leq 0.3A$		0.2		%	
Output Current Limit	I_{LIM}	$V_{OUT} = 0$	600	1100		mA	
Power Supply Rejection Ratio ($I_{LOAD} = 5mA$)	PSRR	$V_{OUT} = 1.2V$, $V_{IN} = 2V$	$f = 100Hz$	--	80	--	dB
			$f = 1kHz$	--	75	--	
Output Voltage Noise (BW = 10Hz to 100kHz, $C_{OUT} = 1\mu F$.)	Noise	$V_{IN} = 3.5V$ $I_{LOAD} = 0.1A$	$V_{OUT} = 0.9V$	--	40	--	μV_{RMS}
			$V_{OUT} = 2.8V$	--	50	--	
Thermal Shutdown Temperature	T_{SD}	$I_{LOAD} = 10mA$		--	155	--	$^\circ C$
Thermal Shutdown Hysteresis	ΔT_{SD}			--	15	--	$^\circ C$
Discharge Resistance		$EN = 0V$, $V_{OUT} = 0.1V$	--	100	--	Ω	

Typical Characteristics

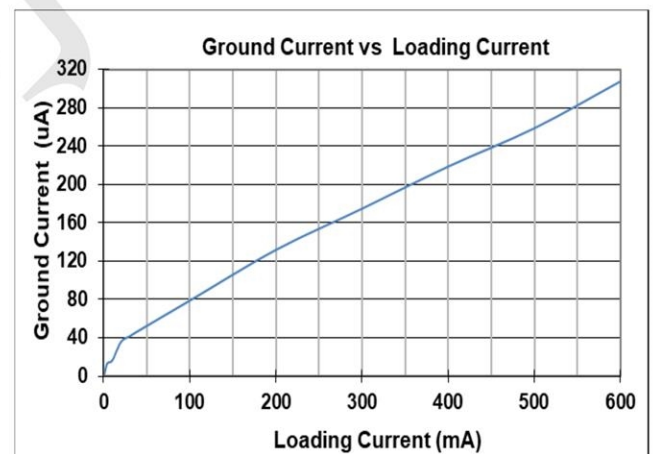
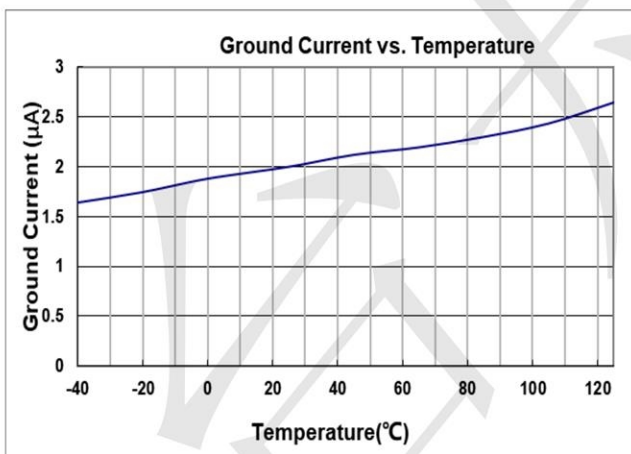
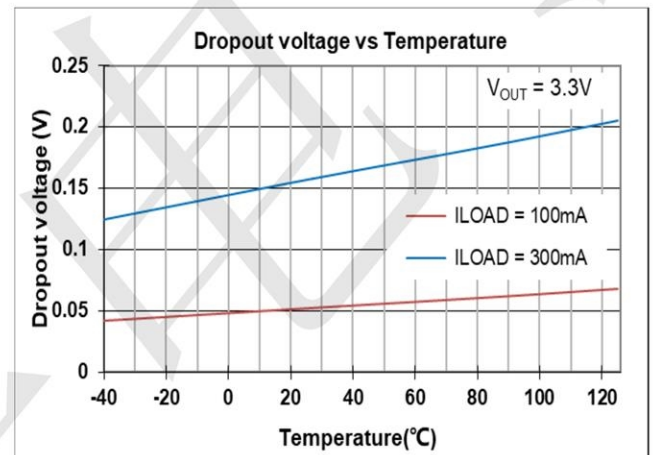
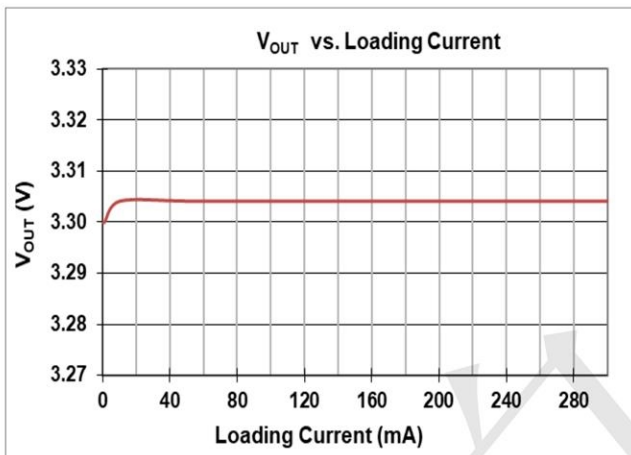
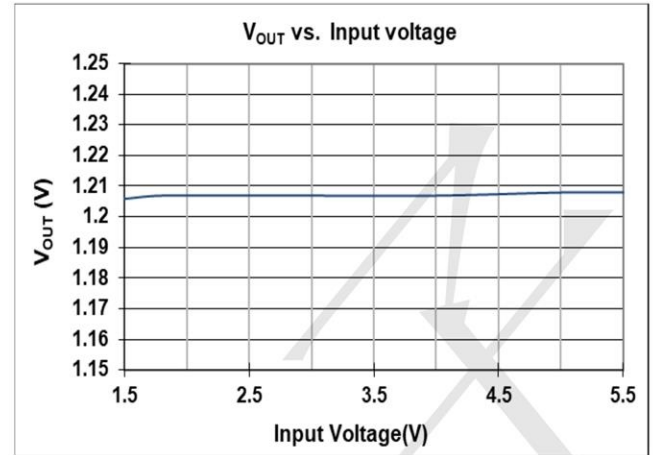
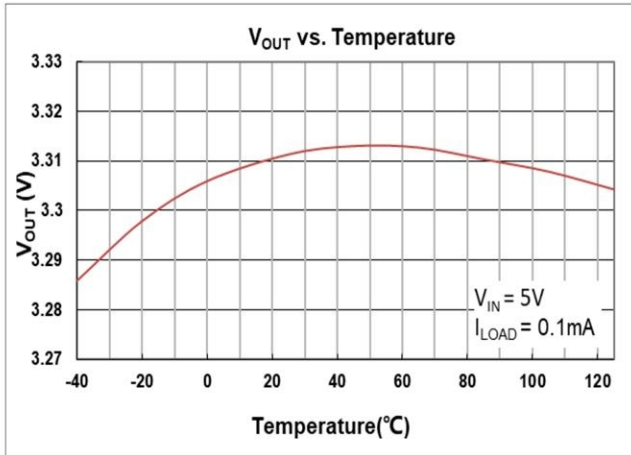

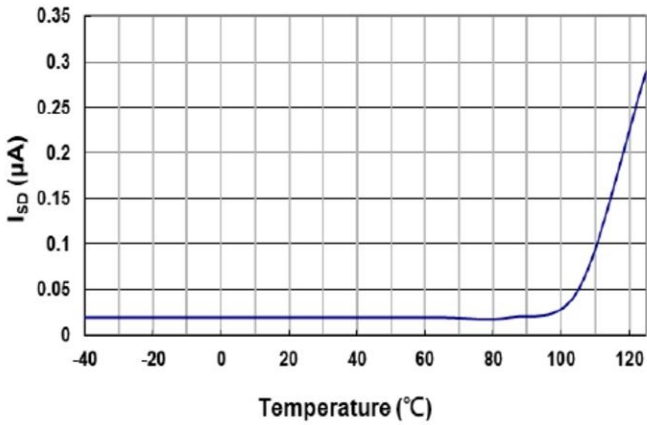

Fig. 11 Shutdown Ground Current vs. Temperature

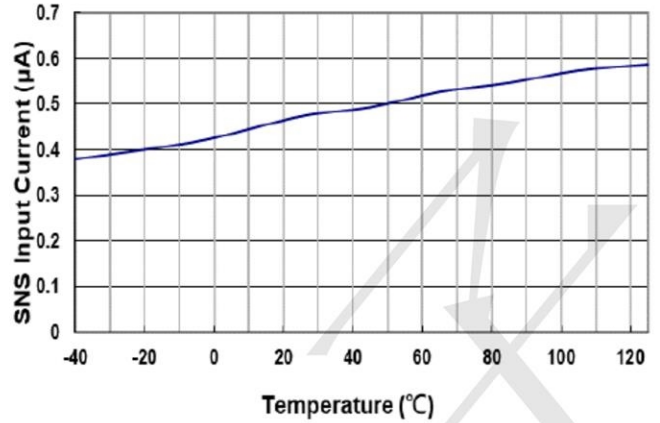

Fig. 12 SNS Input Current vs. Temperature

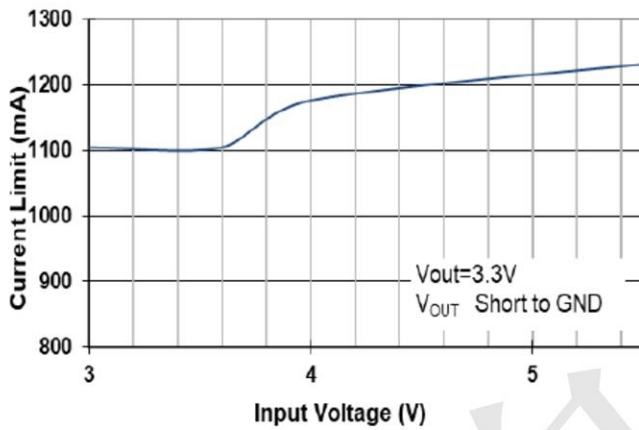

Fig. 13 Current Limit vs. Input Voltage

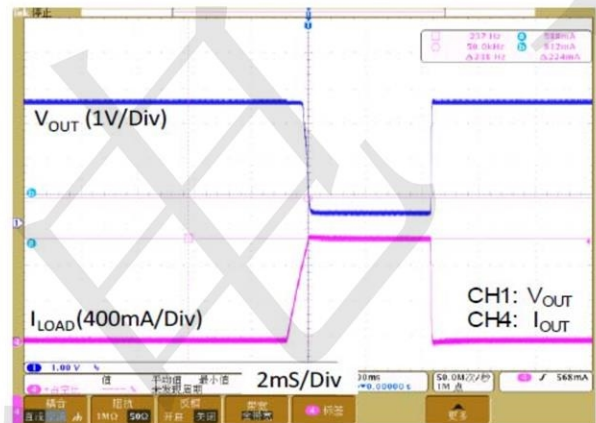

Fig. 14 Current Limit Response

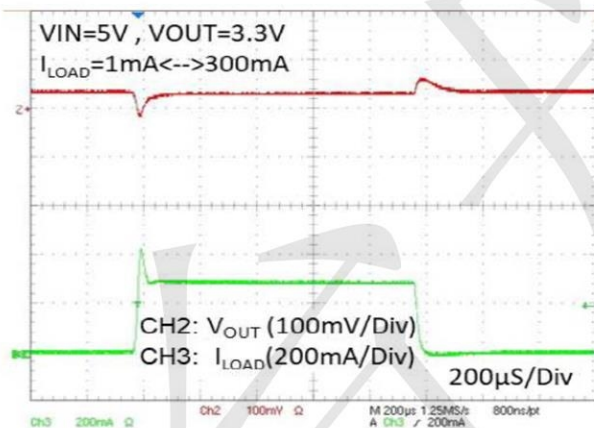

Fig. 15 Load Transient Response

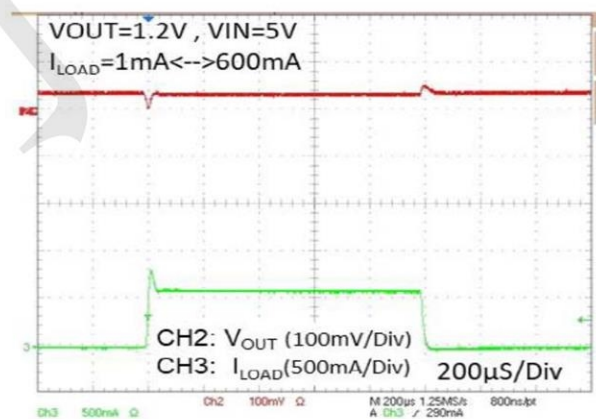
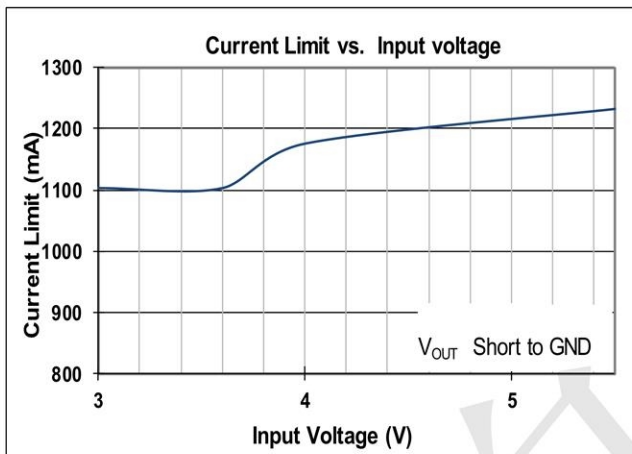
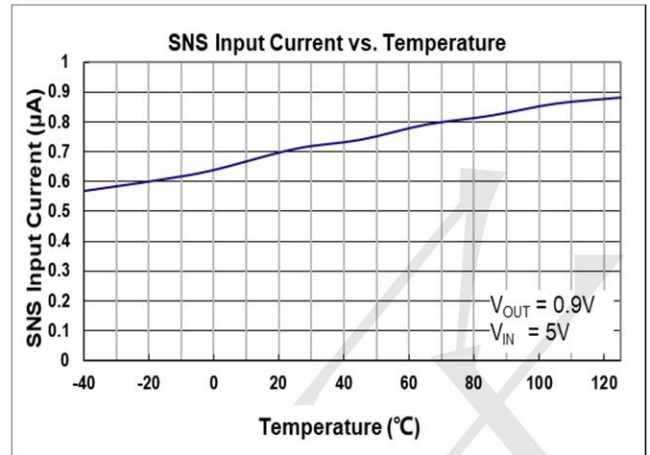
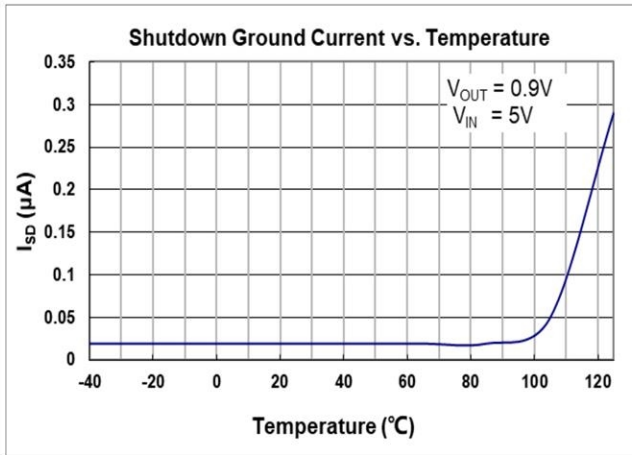
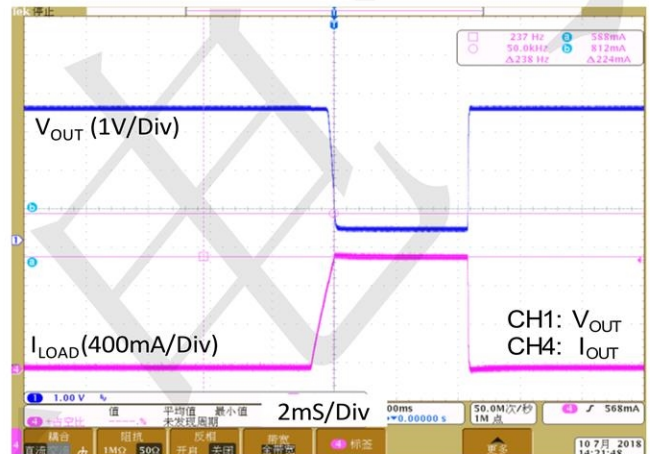

Fig. 16 Load Transient Response



Current Limit Response



Load Transient Response I

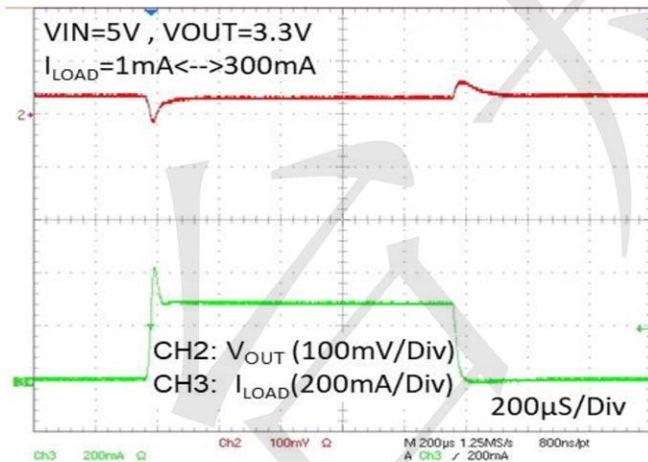

Load Transient Response II

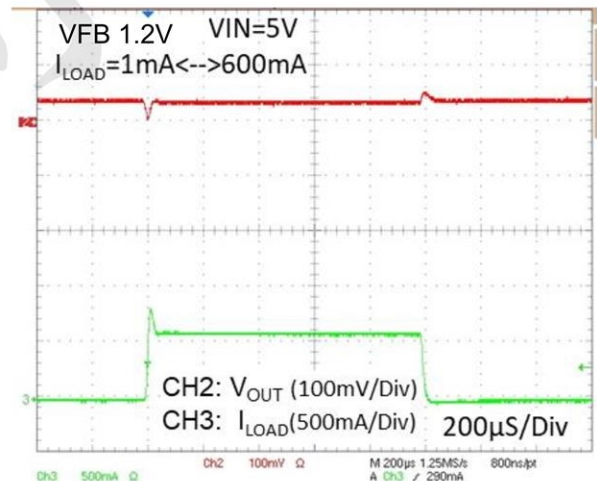

Line Transient Response

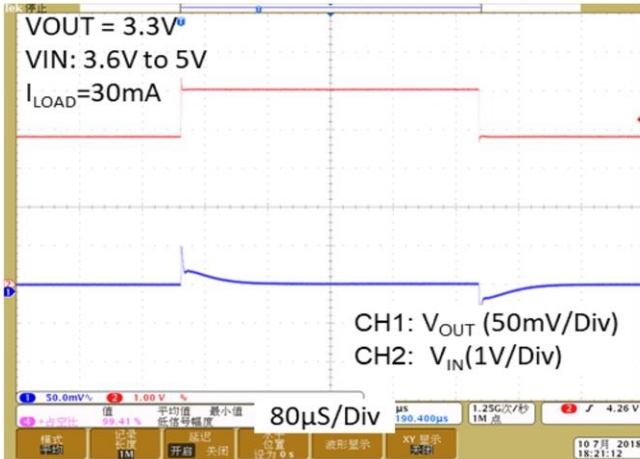

V_{OUT} Turn On/Off by EN

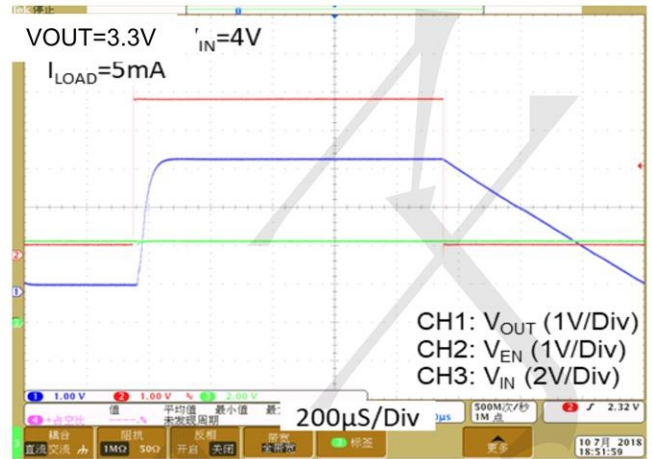

PSRR vs. Frequency

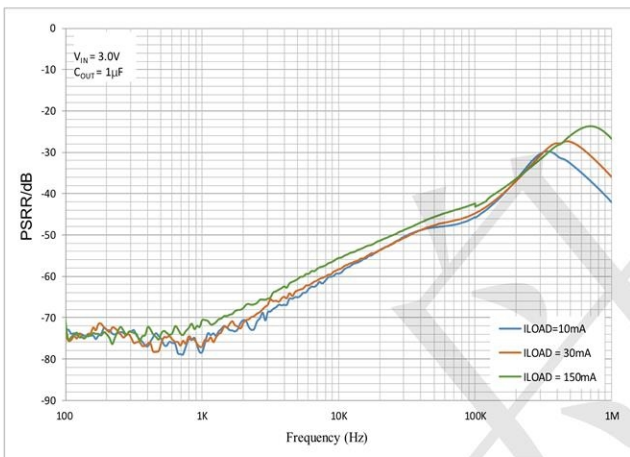

Noise Density Spectrum

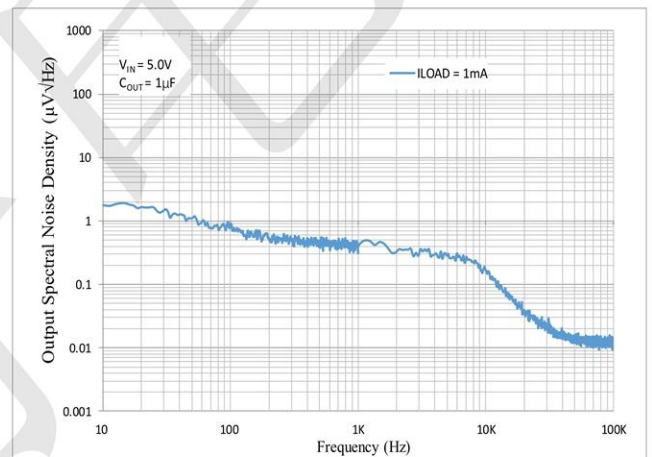



TECH PUBLIC

— 台用电子 —

TPRT9080N-08GJ5

2uA 600mA Ultra-LowDropout Regulator

www.sot23.com.tw

Package information

SOT23-5

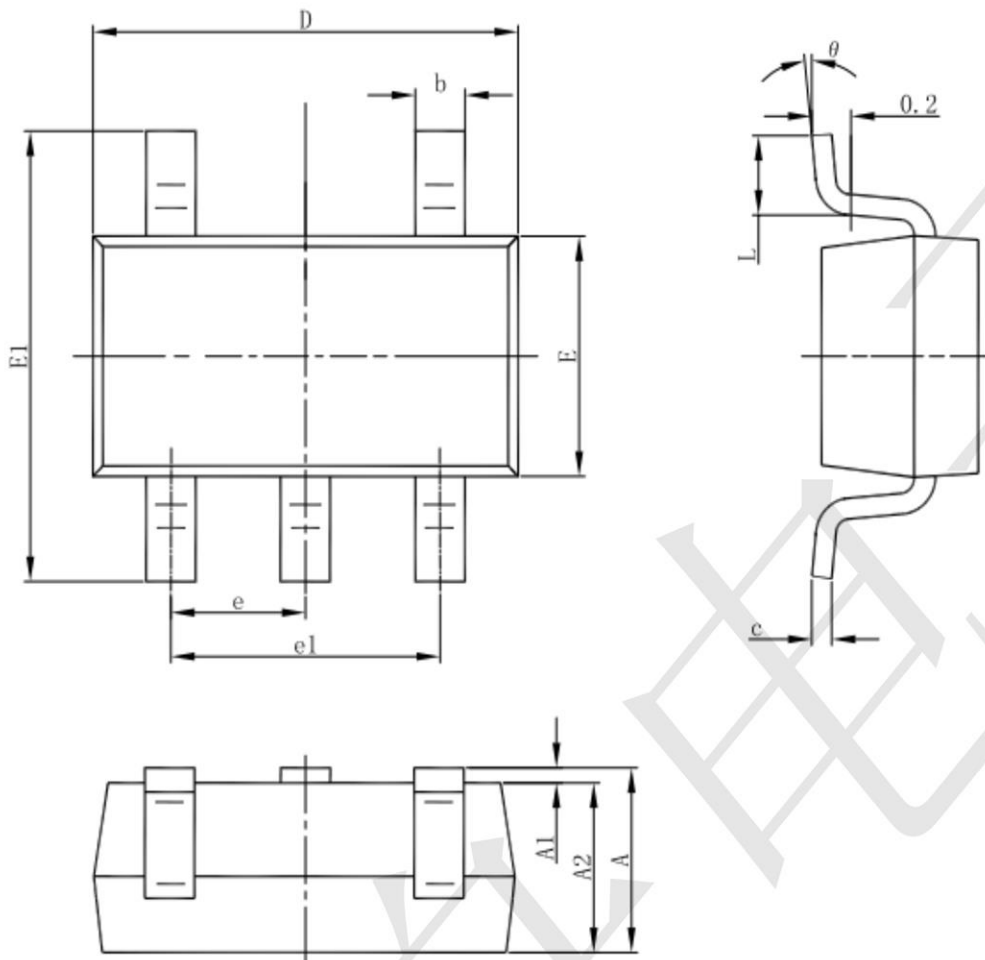

Symbol	Dimensions In Millimeters		Dimensions In Inches	
	Min	Max	Min	Max
A	1.050	1.250	0.041	0.049
A1	0.000	0.100	0.000	0.004
A2	1.050	1.150	0.041	0.045
b	0.300	0.500	0.012	0.020
c	0.100	0.200	0.004	0.008
D	2.820	3.020	0.111	0.119
E	1.500	1.700	0.059	0.067
E1	2.650	2.950	0.104	0.116
e	0.950(BSC)		0.037(BSC)	
e1	1.800	2.000	0.071	0.079
L	0.300	0.600	0.012	0.024
θ	0°	8°	0°	8°

X-ON Electronics

Largest Supplier of Electrical and Electronic Components

Click to view similar products for [Linear Voltage Regulators](#) category:

Click to view products by [TECH PUBLIC](#) manufacturer:

Other Similar products are found below :

[LV56831P-E](#) [LV5684PVD-XH](#) [MCDTSA6-2R](#) [L7815ACV-DG](#) [PQ3DZ53U](#) [LV56801P-E](#) [TLE42794G](#) [L78L05CZ/1SX](#) [L78LR05DL-MA-E](#) [636416C](#) [714954EB](#) [BA033LBSG2-TR](#) [LV5680P-E](#) [L78M15CV-DG](#) [L79M05T-E](#) [TLS202A1MBVHTSA1](#) [L78LR05D-MA-E](#) [NCV317MBTG](#) [NTE7227](#) [LV5680NPVC-XH](#) [LT1054CN8](#) [MP2018GZD-5-Z](#) [MP2018GZD-33-Z](#) [MIC5281-3.3YMM](#) [MC78L06BP-AP](#) [TA48LS05F\(TE85L,F\)](#) [TA78L12F\(TE12L,F\)](#) [TC47BR5003ECT](#) [TCR2LN12,LF\(S](#) [TCR2LN28,LF\(S](#) [TCR2LN30,LF\(S](#) [TCR3DF295,LM\(CT](#) [TCR3DF40,LM\(CT](#) [BA178M20CP-E2](#) [L78M12ABDT](#) [LM7812SX/NOPB](#) [LR645N3-G-P003](#) [LR645N3-G-P013](#) [ZXTR2005P5-13](#) [SCD7812BTG](#) [TCR3DF335,LM\(CT](#) [ZXTR2012K-13](#) [TLE42994E V33](#) [ZXTR2008K-13](#) [ZXTR2005K-13](#) [L88R05DL-E](#) [ADP3300ARTZ-2.7RL7](#) [LM120K-15/883](#) [IFX54441LDVXUMA1](#) [LM317D2T-TR](#)