

Product Summary

- V_{DS} -250 V
- I_{DS} -0.19 A
- $R_{DS(ON)}$ (at $V_{GS}=-10V$) <14 Ω

Application

- Solid-State Relays
- Portable equipment and battery
- Telecommunication Switches

Package and Pin Configuration

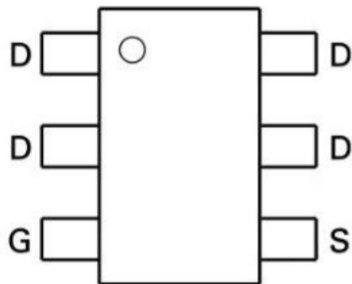

SOT23-6

Circuit diagram

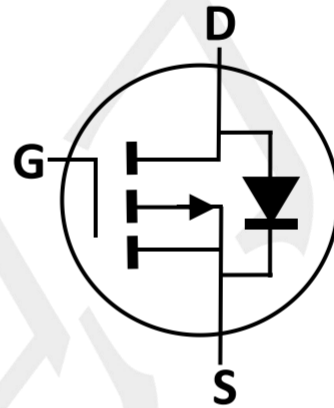

Equivalent Circuit

Marking:P52

Absolute Maximum Ratings (T_A=25°C unless otherwise noted)

PARAMETER	SYMBOL	LIMIT	UNIT
Drain-Source Voltage	V_{DS}	-250	V
Gate-Source Voltage	V_{GS}	±20	V
Continuous Drain Current	I_D	$T_C=25^\circ C$	-0.19
		$T_C=70^\circ C$	-0.12
Pulsed Drain Current	I_{DM}	-1	A
Total Power Dissipation	P_{DTOT}	1.6	W
Operating Junction Temperature Range	T_J	-55 to +150	°C
Storage Temperature Range	T_{stg}	-55 to +150	°C

Thermal Characteristic

PARAMETER	Symbol	Value	Unit
Junction-to-Ambient Thermal Resistance	R_{thJA}	110	°C/W

Note : When mounted on 1" square PCB (FR4 material).

Electrical Characteristics (T_A=25°C unless otherwise noted)

PARAMETER	CONDITIONS	SYMBOL	MIN	TYP	MAX	UNIT
Static						
Drain-Source Breakdown Voltage	V _{GS} =0V, I _D =-2mA	BV _{DSS}	-250	--	--	V
Gate-Source Threshold Voltage	V _{DS} =V _{GS} , I _D = -1mA	V _{GS(th)}	-1	-1.5	-2.5	V
Gate-Source Leakage	V _{DS} =0V, V _{GS} = ±20V	I _{GSS}	--	--	±100	nA
Zero Gate Voltage Drain Current	V _{DS} = -220V, V _{GS} =0V	I _{DSS}	--	--	-1	μA
	V _{DS} = -220V, T _J =125°C		--	--	-800	μA
Drain-Source On-State Resistance (Note 1)	V _{GS} = -10V, I _D = -0.2A	R _{DS(on)}	--	10	14	Ω
	V _{GS} = -4.5V, I _D = -0.1A		--	13	18	
Forward Transconductance (Note 2)	V _{DS} = -10V, I _D = -0.15A	g _{fs}	--	0.5	--	S
Dynamic (Note 2)						
Total Gate Charge (Note 3)	V _{DS} = -25V, I _D = -0.2A, V _{GS} = -10V	Q _g	--	2.4	--	nC
Gate-Source Charge (Note 3)		Q _{gs}	--	0.2	--	
Gate-Drain Charge (Note 3)		Q _{gd}	--	0.5	--	
Input Capacitance	V _{DS} = -25V, V _{GS} = 0V, F= 1.0MHz	C _{iss}	--	73	--	pF
Output Capacitance		C _{oss}	--	13	--	
Reverse Transfer Capacitance		C _{rss}	--	8	--	
Switching						
Turn-On Delay Time (Note 3)	V _{DD} = -30V, I _D = -0.2A, V _{GS} = -10V, R _{GEN} = 50Ω	t _{d(on)}	--	1.53	--	nS
Rise Time (Note 3)		t _r	--	3.78	--	
Turn-Off Delay Time (Note 3)		t _{d(off)}	--	17.5	--	
Fall Time (Note 3)		t _f	--	7.85	--	
Source-Drain Diode Ratings and Characteristics (Note 2)						
Forward Voltage	V _{GS} = 0V, I _F = -0.2A	V _{SD}	--	-0.78	-1.2	V
Continuous Source Current	Integral reverse diode in the MOSFET	I _S	--	--	-0.19	A
Pulsed Current (Note 1)		I _{SM}	--	--	-1	A

Notes:

1. Pulse test; pulse width ≤ 300 μs, duty cycle ≤ 2%.
2. Guaranteed by design, not subject to production testing.
3. Independent of operating temperature

TYPICAL CHARACTERISTICS (25 °C, unless otherwise noted)

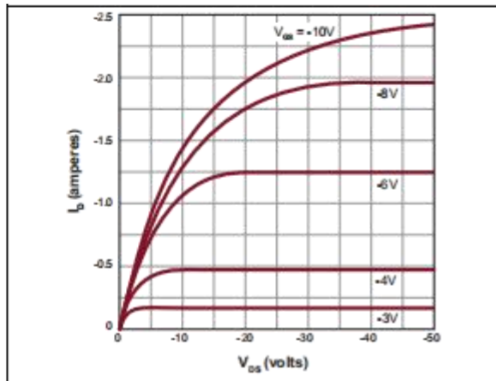

Output Characteristics.

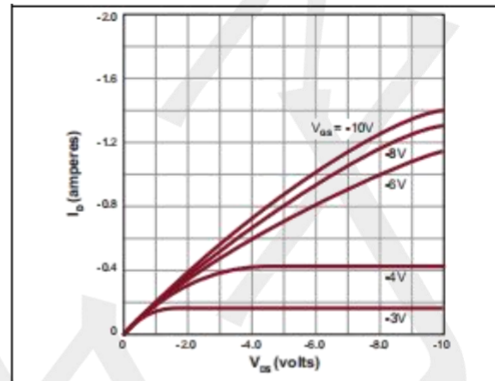

Saturation Characteristics.

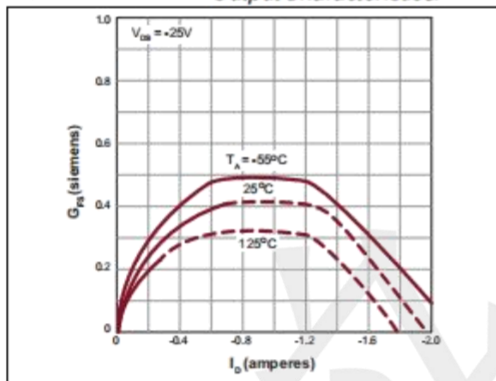

Transconductance vs. Drain

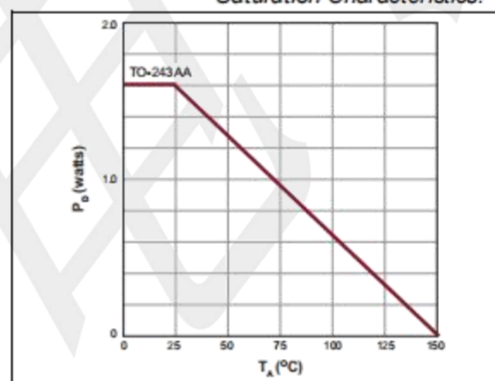

Power Dissipation vs.

Current.

Ambient Temperature.

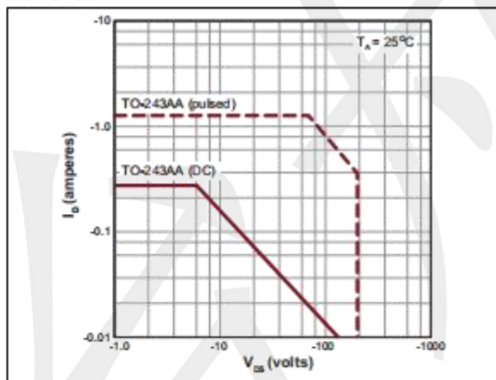

Maximum Rated Safe

Operating Area.

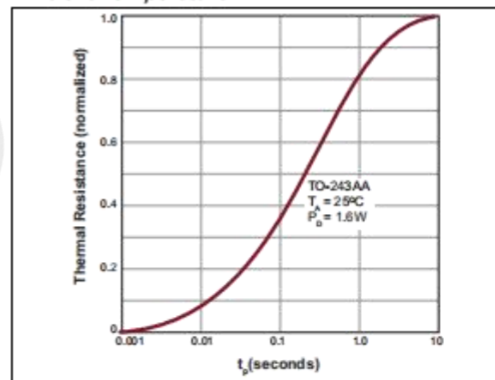

Thermal Response

Characteristics.

TYPICAL CHARACTERISTICS (25 °C, unless otherwise noted)

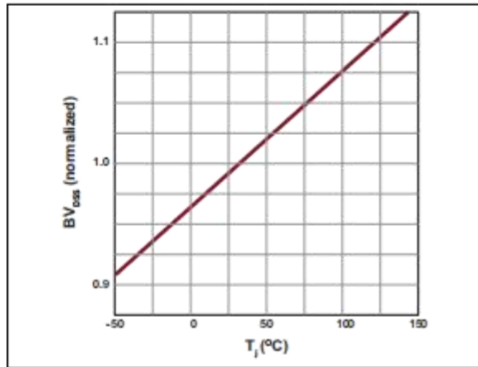

BV_{DSS} Variation with

Temperature.

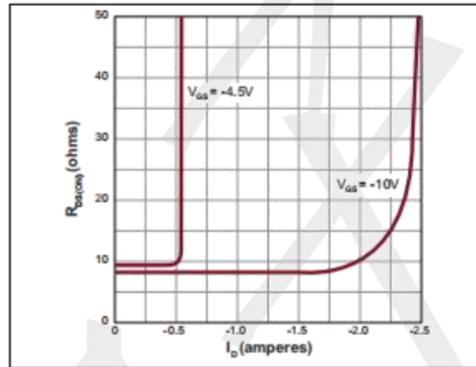

On-Resistance vs. Drain

Current.

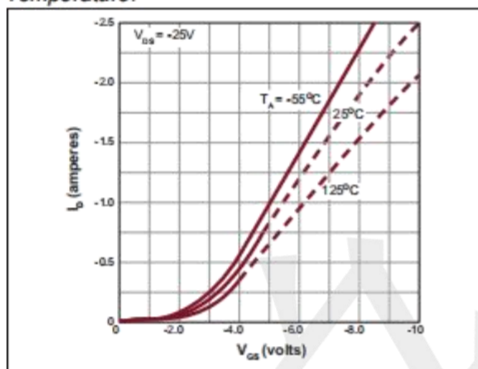

Transfer Characteristics.

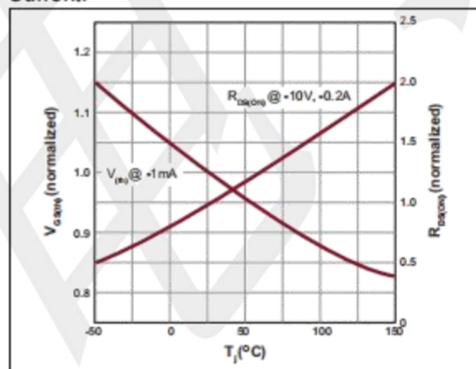

V_{GS(th)} and R_{DS} Variation

with temperature.

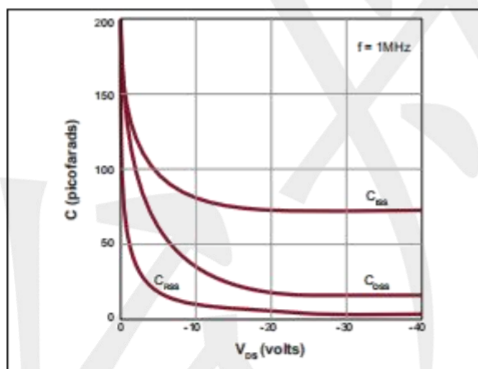

Capacitance vs.

Drain-to-Source Voltage.

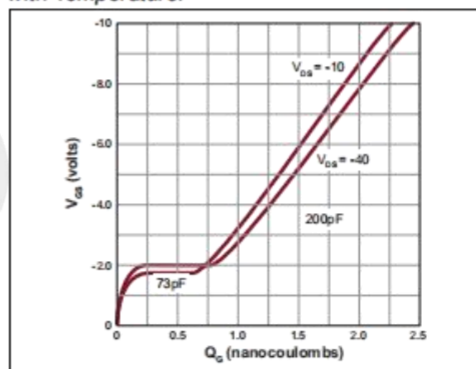

Gate Drive Dynamic

Characteristics.

* The power dissipation PD is based on T_{J(max)} = 150 °C, using junction-to-case thermal resistance, and is more useful in settling the upper dissipation limit for cases where additional heatsinking is used. It is used to determine the current rating, when this rating falls below the package limit.

SOT23-6 Package Outline Dimensions

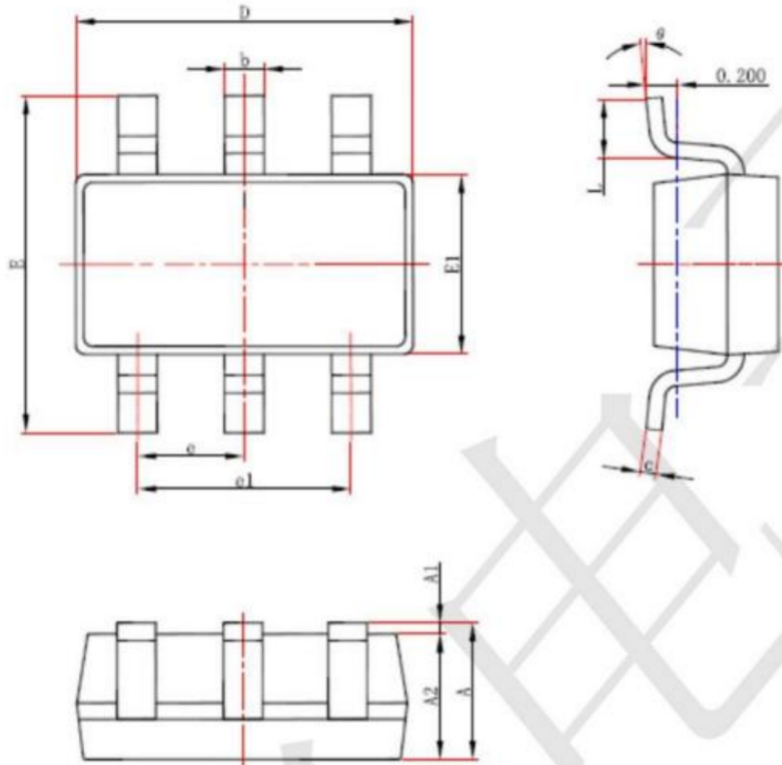

Symbol	Dimensions In Millimeters		Dimensions In Inches	
	Min.	Max.	Min.	Max.
A	1.050	1.250	0.041	0.049
A1	0.000	0.100	0.000	0.004
A2	1.050	1.150	0.041	0.045
b	0.300	0.500	0.012	0.020
c	0.100	0.200	0.004	0.008
D	2.820	3.020	0.111	0.119
E1	1.500	1.700	0.059	0.067
E	2.650	2.950	0.104	0.116
e	0.950(BSC)		0.037(BSC)	
e1	1.800	2.000	0.071	0.079
L	0.300	0.600	0.012	0.024
θ	0°	8°	0°	8°

X-ON Electronics

Largest Supplier of Electrical and Electronic Components

Click to view similar products for [MOSFET](#) category:

Click to view products by [TECH PUBLIC](#) manufacturer:

Other Similar products are found below :

[IRFD120](#) [JANTX2N5237](#) [BUK455-60A/B](#) [MIC4420CM-TR](#) [VN1206L](#) [NDP4060](#) [SI4482DY](#) [IPS70R2K0CEAKMA1](#) [SQD23N06-31L-GE3](#)
[TK16J60W,S1VQ\(O](#) [2SK2614\(TE16L1,Q\)](#) [DMN1017UCP3-7](#) [DMN1053UCP4-7](#) [SQJ469EP-T1-GE3](#) [NTE2384](#) [DMC2700UDMQ-7](#)
[DMN2080UCB4-7](#) [DMN61D9UWQ-13](#) [US6M2GTR](#) [DMN31D5UDJ-7](#) [DMP22D4UFO-7B](#) [DMN1006UCA6-7](#) [DMN16M9UCA6-7](#)
[STF5N65M6](#) [IRF40H233XTMA1](#) [STU5N65M6](#) [DMN6022SSD-13](#) [DMN13M9UCA6-7](#) [DMTH10H4M6SPS-13](#) [DMN2990UFB-7B](#)
[IPB80P04P405ATMA2](#) [2N7002W-G](#) [MCAC30N06Y-TP](#) [MCQ7328-TP](#) [NTMC083NP10M5L](#) [BXP7N65D](#) [BXP4N65F](#) [AOL1454G](#)
[WMJ80N60C4](#) [BXP2N20L](#) [BXP2N65D](#) [BXT1150N10J](#) [BXT1700P06M](#) [TSM60NB380CP](#) [ROG](#) [RQ7L055BGTGR](#) [DMNH15H110SK3-13](#)
[SLF10N65ABV2](#) [BSO203SP](#) [BSO211P](#) [IPA60R230P6](#)