

REV	ECN NO	DESCRIPTION	DESIGN	DATE
A	TE2020-XXXX	New Drawing	Quan Lei	2020/03/30

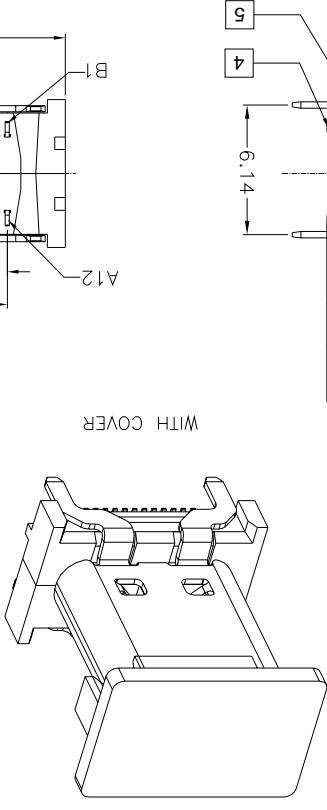

1. Contact Resistance: 40mOHM Max.;
2. Dielectric Withstanding Voltage: 100V AC For 1 Minute;
3. Insulation Resistance: 100M OHM Min.;
4. Mating And Unmating Force:
- Mating Force: 5~20N
- Unmating Force: 8~20N;
5. Durability: 10000 Cycles;
6. ~20N AFTER TEST;

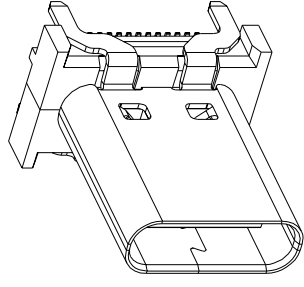
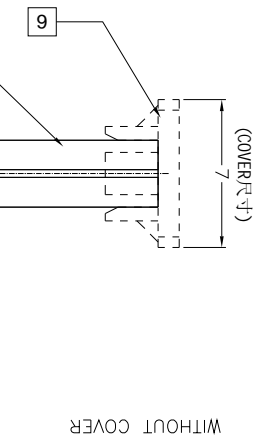
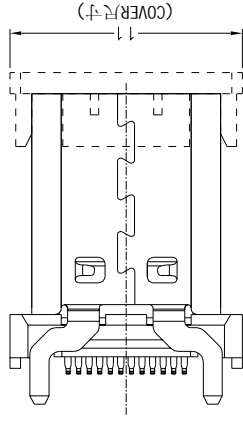
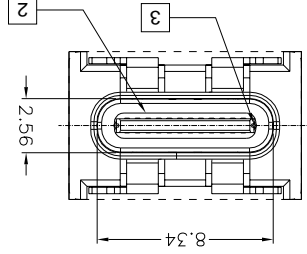
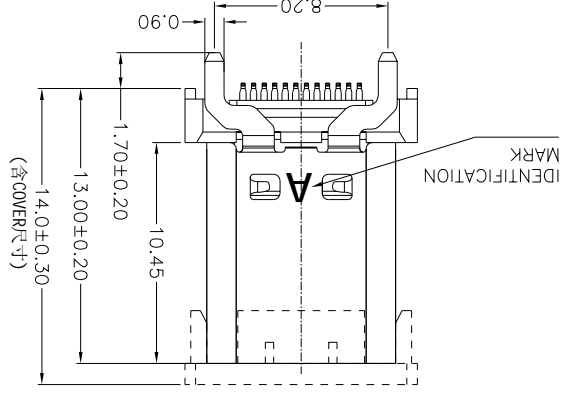
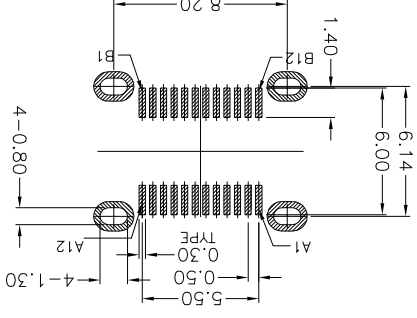
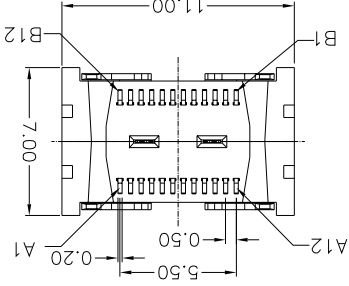

A402403-A-XX-R

Mating Area plating

01: Au 1u"Min.
03: Au 3u"Min.
05: Au 5u"Min.
10: Au 10u"Min.
15: Au 15u"Min.
30: Au 30u"Min.

RECOMMEND P.C.B LAYOUT(COMPONENT SIDE)

TOLERANCE FOR PCB LAYOUT IS ± 0.05

KEEP OUT AREA

APD:	Lebon Lee	X. ± 0.35	
CHKD:		.XX ± 0.15	
DR:	Quan Lei	.XXX ± 0.10	
TITLE:	USB 3.1 TYPE C FEMALE VERTICAL H13.0mm SMT TYPE	X. ± 1.5*	
PART NO:	A402403-A-XX-R	UNITS:	mm
DWG NO:	C-A402403-A-XX-R	SCALE:	3:1
CUSTOMER DRAWING			
REV: A			

Item	Title	Material	Dispose	QTY
1	Shell	Stainless Steel	Ni:30u" Min.	1PCS
2	GND Plate	Stainless Steel		2PCS
3	Mid Plate	Stainless Steel		1PCS
4	Contact	Copper Alloy	Solder Tails: Molt Tin	2PCS
5	InsertWelding	LCP	UL 94Y-0 Black	1PCS
6	COVER	LCP	UL 94Y-0 Black	1PCS

THE PART MEETS TECONN "GP001" COMPLIANCE NEW REV.



X-ON Electronics

Largest Supplier of Electrical and Electronic Components

Click to view similar products for [USB Connectors](#) category:

Click to view products by [TECONN](#) manufacturer:

Other Similar products are found below :

[10033527-N3112MLF](#) [17-210561](#) [GMCB05B11124H1EU](#) [17-200931](#) [65-647-8-BK-BU](#) [690-010-295-484](#) [73725-1191BLF](#) [950](#) [E8144-B01021-L](#) [A-USB A-LP-SMT-C](#) [A-USB B-TOP-C](#) [MUSBA511N5](#) [MUSBB15131](#) [MUSBC111M5](#) [MUSBD11135](#) [217450-1](#) [CA 6 W LD](#)
[896-30-004-00-000000](#) [KUSBVX-BS1N-W30](#) [KUSBX-AP-KIT-SCBLK](#) [KUSBX-AS2N-W](#) [KUSBX-SMT2AP1S-W](#) [KUSBX-SMTAS1NBTR](#) [KUSBX-SMTBS1NBTR](#) [30-498-6](#) [SK-60A-2](#) [17-200261](#) [17-210051](#) [1734082-1](#) [FK-37-32SL](#) [30-1574](#) [30-470](#) [30-489](#) [30-541](#) [30-572-3](#) [30-9503](#) [M9177/2-1](#) [MAB 5 S](#) [MIKROE-1451](#) [33UBBR-04SW11R](#) [USBFTV2PEM2G](#) [USBFTVC6ZN](#) [USBFTVSCCG](#)
[KUSBX-AS2N-W30](#) [KUSBX-SLAS1N-W](#) [KUSBX-SLAS1N-W30](#) [1-1734084-2](#) [E8110-001-01](#) [MUSBC11135](#) [NK-27-32SL](#)