

Raychem Data Bus Components

Interconnection Hardware

A Complete High-Performance System of Interconnection Hardware for MIL-STD-1553B Networks and Space Applications

Data Bus Components

Interconnection Hardware for MIL-STD-1553B Networks and Space Applications



Description

Based on unique material technologies, the TE Connectivity (TE) family of data bus components offers innovative solutions to today's aerospace, space, defense and marine data bus applications.

Used in MIL-STD-1553B multiplexing applications, coupled with proven field experience, the Raychem data bus system provides high packaging density, weight savings, design flexibility, and high performance to 150°C.

Custom harnesses built to your drawing specifications are also available. Pre-tested, factory built harnesses provide quick, easy installation and eliminate unnecessary splices and connectors, reducing cost and increasing network reliability.



MORE CHOICE

- A wide selection of couplers such as micros, boxes, and ultra-lightweight versions
- Low outgassing components for use in space
- HARNWARE harness design software

RUGGED RELIABILITY

- Triax connectors and contacts with strain relief
- One-piece triaxial contacts for MIL-DTL-38999 connectors

COMPLETE SYSTEMS

- Data bus cables and identification sleeves
- Bus and stub terminators
- Flexible cable splices

TE Components . . . TE Technology . . . TE Know-how . . .

AMP | AGASTAT | CII | HARTMAN | KILOVAC | MICRODOT | NANONICS | POLAMCO | Raychem | Rochester | DEUTSCH
SEACON Phoenix | LL ROWE | Phoenix Optix | AFP | SEACON

Get your product to market faster with a smarter, better solution.



System Illustration

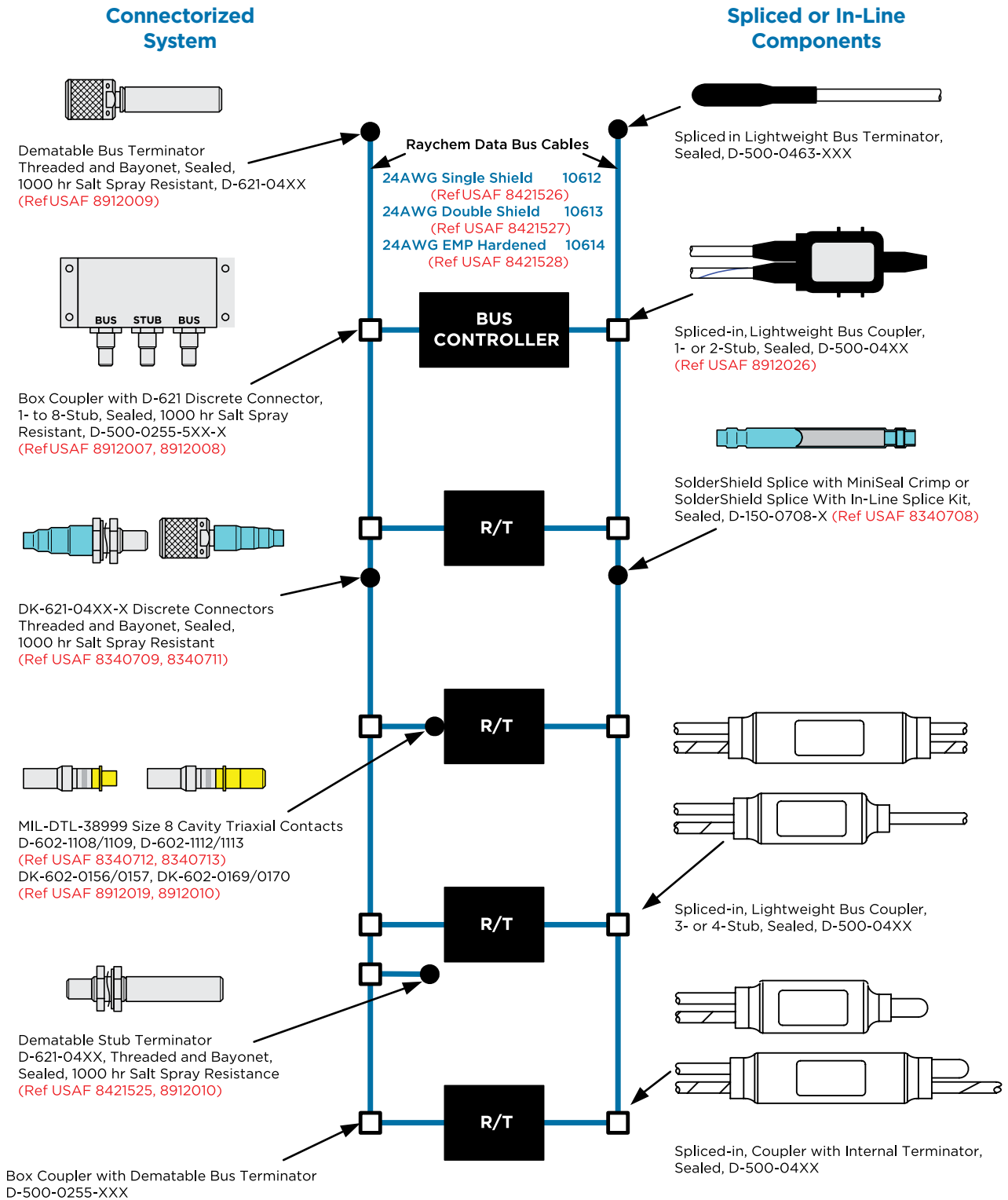



Ultra Lightweight In-Line Microcouplers 1- through 6-Stub

Applications

Building on over 20 years of experience and continuous improvement in data bus, including pioneering in-line microcouplers, TE offers a family of ultra lightweight in-line microcouplers, available in 1- through 6-stub configurations.

These couplers offer the same high performance and reliability as TE's current microcouplers, but their weight is further reduced. They are available in configurations up to 6-stub. There is no option with a mounting eyelet.

Combined with Raychem 24 AWG data bus cables, these ultra light couplers allow designers to significantly reduce weight.

They are also available assembled with other customer specified components into a complete factory-built and tested data bus harness.

Lightweight In-Line Coupler Part Numbering

D-500-L4 **5** **W** - **X** - **YYY** - **ZZZ**

BOOT

5 Without Mounting Eyelet

DESIGN

- 5** Without Internal Terminator
- 6** Same as 5 but with Reverse Bus
- 7** With Internal Terminator
- 8** Same as 7 but with Reverse Bus

NUMBER OF STUBS

1, 2, 3, 4, 5 or 6

CABLE TYPE

- 612** 10612 (24 AWG Single Optimized Shield)
- 613** 10613 (24 AWG Double Optimized Shield)
- 614** 10614 (24 AWG EMP Hardened)

STANDARD CABLE LENGTH

- 012** 12 In (1 Ft)
- 078** 78 In (6.5 Ft)
- 079** 79 In (2 m)
- 120** 120 In (10 Ft)
- 236** 236 In (6 m)
- 240** 240 In (20 Ft)

Specifications/Approvals

Series	Military	TE Connectivity
D-500-L4XX	MIL-STD-1553B	D-6020



Ultra Lightweight In-Line Microcouplers 1- through 6-Stub

Product Selection

D-500-L455-X-YYY-ZZZ

End View Left Side		End View Right Side
	1 Stub	
	2 Stub	
	3 Stub	
	4 Stub	
	5 Stub	
	6 Stub	

D-500-L456-X-YYY-ZZZ

End View Left Side		End View Right Side
	1 Stub	
	2 Stub	
	3 Stub	
	4 Stub	
	5 Stub	
	6 Stub	

D-500-L457-X-YYY-ZZZ

End View Left Side		End View Right Side
	1 Stub	
	2 Stub	
	3 Stub	
	4 Stub	
	5 Stub	
	6 Stub	

D-500-L458-X-YYY-ZZZ

End View Left Side		End View Right Side
	1 Stub	
	2 Stub	
	3 Stub	
	4 Stub	
	5 Stub	
	6 Stub	



Microcouplers

Compact, in-line, splice-terminated data bus microcouplers feature a lightweight design that meets the MIL-STD-1553B requirements for hardware configuration and performance. The low profile configuration enables avionics system designers to plan for optimum coupler locations.

TE data bus microcouplers are qualified to TE Specification D-6020, European Specification EN3567, and are specified in the Air Force drawings listed in 8340707. Standard products are supplied with Raychem SPEC 55 data bus cables, including EMP-hardened versions. All of these products are available assembled with other components into a complete data bus harness without splices.

EASY INSTALLATION

- No connectors
- Optional eyelet configurations for bulkhead mounting

COMPACT

- Very small size, light weight: 1 stub: 10 g (max.); 2 stub: 15 g (max.) (Lighter weight versions are available)
- In-line profile to enable wire bundle mounting

RUGGED RELIABILITY

- Reliable solder termination of all components
- Potted circuit elements for maximum durability and in-use reliability
- Altitude immersion resistance

ROBUST

- Environmental sealing and 150°C temperature rating
- 360° continuous low-impedance cable shield terminations
- MTBF > 1,000,000 hours

Specifications/Approvals

Series	Military	TE Connectivity
D-500-04XX	MIL-STD-1553B	D-6020



Data Bus Components

MicroCoupler Part Numbering

D-500-04 **X** **X** - **X** - **YYY** - **ZZZ**

BOOT

- 5** Without Mounting Eyelet
- 6** With Mounting Eyelet

DESIGN

- 5** Without Internal Terminator
- 6** Same as 5 but with Reverse Bus
- 7** With Internal Terminator
- 8** Same as 7 but with Reverse Bus

NUMBER OF STUBS

1 or 2

CABLE TYPE

- 612** 10612 (24 AWG Single Optimized Shield)
- 613** 10613 (24 AWG Double Optimized Shield)
- 614** 10614 (24 AWG EMP Hardened)

STANDARD CABLE LENGTH

- 012** 12 In (1 Ft)
- 078** 78 In (6.5 Ft)
- 079** 79 In (2 m)
- 120** 120 In (10 Ft)
- 236** 236 In (6 m)
- 240** 240 In (20 Ft)

In-Line Microcouplers: One and Two Stub

Single Stub		Double Stub	
D-500-0455-1-YYY-ZZZ		D-500-0455-2-YYY-ZZZ	
D-500-0465-1-YYY-ZZZ		D-500-0465-2-YYY-ZZZ	
D-500-0456-1-YYY-ZZZ		D-500-0456-2-YYY-ZZZ	
D-500-0466-1-YYY-ZZZ		D-500-0466-2-YYY-ZZZ	
D-500-0457-1-YYY-ZZZ		D-500-0457-2-YYY-ZZZ	
D-500-0467-1-YYY-ZZZ		D-500-0467-2-YYY-ZZZ	
D-500-0458-1-YYY-ZZZ		D-500-0458-2-YYY-ZZZ	
D-500-0468-1-YYY-ZZZ		D-500-0468-2-YYY-ZZZ	

Note:

- 1. Bus cable
- 2. Stub cable



Data Bus Box Couplers 1- through 8-Stub

Raychem data bus box couplers provide lightweight, robust coupler modules with connector versatility.

Up to eight stub connectors can be arrayed on the “face” of the box coupler. The bus connectors can also be on the “face” or on the “side” of the box.

Designed with Raychem D-621 series corrosion-resistant threaded or bayonet-type connectors, box couplers are qualified to TE Specification D-6021.

Customized data bus box couplers are available upon request.

Data Bus Box Couplers

Coupler Type	Part No.			
	Threaded	Bayonet A	Bayonet B	Bayonet C
Face - 1 Stub	D-500-0255-511-1	D-500-0255-513-1	D-500-0255-515-1	D-500-0255-517-1
Face - 2 Stub	D-500-0255-521-1	D-500-0255-523-1	D-500-0255-525-1	D-500-0255-527-1
Face - 3 Stub	D-500-0255-531-1	D-500-0255-533-1	D-500-0255-535-1	D-500-0255-537-1
Face - 4 Stub	D-500-0255-541-1	D-500-0255-543-1	D-500-0255-545-1	D-500-0255-547-1
Face - 5 Stub	D-500-0255-551-1	D-500-0255-553-1	D-500-0255-555-1	D-500-0255-557-1
Face - 6 Stub	D-500-0255-561-1	D-500-0255-563-1	D-500-0255-565-1	D-500-0255-567-1
Face - 7 Stub	D-500-0255-571-1	D-500-0255-573-1	D-500-0255-575-1	D-500-0255-577-1
Face - 8 Stub	D-500-0255-581-1	D-500-0255-583-1	D-500-0255-585-1	D-500-0255-587-1
Side - 1 Stub	D-500-0255-512-1	D-500-0255-513-2	D-500-0255-515-2	D-500-0255-517-2
Side - 2 Stub	D-500-0255-522-1	D-500-0255-523-2	D-500-0255-525-2	D-500-0255-527-2
Side - 3 Stub	D-500-0255-532-1	D-500-0255-533-2	D-500-0255-535-2	D-500-0255-537-2
Side - 4 Stub	D-500-0255-542-1	D-500-0255-543-2	D-500-0255-545-2	D-500-0255-547-2
Side - 5 Stub	D-500-0255-552-1	D-500-0255-553-2	D-500-0255-555-2	D-500-0255-557-2
Side - 6 Stub	D-500-0255-562-1	D-500-0255-563-2	D-500-0255-565-2	D-500-0255-567-2
Side - 7 Stub	D-500-0255-572-1	D-500-0255-573-2	D-500-0255-575-2	D-500-0255-577-2
Side - 8 Stub	D-500-0255-582-1	D-500-0255-583-2	D-500-0255-585-2	D-500-0255-587-2



Data Bus Cables





Raychem 55 data bus cables meet or exceed the performance requirements of MIL-STD-1553B.

SPEC 55 insulation is a high-temperature, radiation-cross-linked, modified ETFE material that can be used in wire constructions rated up to 200°C. This insulation is qualified to SAE-AS22759/32-/35 and /41-/46. The cables are made with optimized shielding providing three standard levels of defined EMI/EMP protection. Other shielding options and cable constructions are available.

PHYSICAL PROPERTIES

- Light weight
- Highly flexible
- Rated up to 200°C
- Flame resistant
- Chemical resistant to all known aircraft fluids
- Solder-iron resistant

Product Selection

Cable Type		Part Description
24 AWG Single Optimized Shield		10612*
24 AWG Double Optimized Shield		10613*
24 AWG EMP Hardened		10614*
26 AWG Single Optimized Shield		7726D0664*

* For part numbers and full descriptions, please contact TE.



Data Bus Discrete Connectors

Raychem D-621 and DK-621 series connectors are designed specifically for MIL-STD-1553B data bus applications. In addition to utilizing Raychem’s heat-shrink technology, the D-621 and DK-621 series connectors also feature:

RUGGED RELIABILITY

- Low voltage drop and high reliability due to precisely controlled solder terminations
- 1000-hour salt spray resistance, rugged construction

CONVENIENT

- Light weight, built-in strain relief
- Continuous 360° shield coverage

EASY INSTALLATION

- Low-skill assembly, low total installed cost
- Fast termination time of 1 to 2 minutes
- **Installation Procedures:** ES-61162 and ES-61420

VERSATILE

- Inspectable solder terminations
- Reworkable and repairable terminations
- Removable pin or socket contacts

COMPATIBLE

- Termination with Raychem MIL SPEC and MIL-STD-1553B data bus cables, including EMP-hardened versions
- **Specification:** D-6025

Connector Kit Part Numbering

DK-621 - 04 XX - X X

D-621 CONNECTOR, KITTED WITH ACCESSORIES

BASIC CONNECTOR CONFIGURATIONS

Threaded Styles

- 11** Plug
- 12** Jack

Bayonet Styles

- | | |
|--------------------------------|--------------------------------|
| 33 Plug, A Polarization | 34 Jack, A Polarization |
| 35 Plug, B Polarization | 36 Jack, B Polarization |
| 37 Plug, C Polarization | 38 Jack, C Polarization |
| 39 Plug, D Polarization | 40 Jack, D Polarization |

POLARIZATION (BAYONET STYLES ONLY) (JACK VIEW)

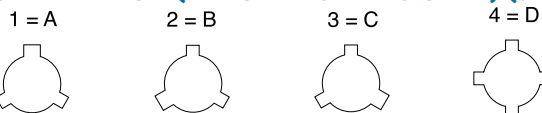

CONTACT (SUPPLIED IN DK-621 KITS ONLY)

- P** Pin
- S** Socket



Triaxial Connectors 1553B Data Bus Cable

Bayonet Connectors

Panel Thickness	Connector	Contact	Connector Reference	Connector	Mate with	
					77 Ohm Bus Terminator	3K Ohm Stub Terminator
Polarity A						
	Plug	Pin	DK-621-0433-1P	DK-621-0434-1S	D-621-0461(-L)	D-621-0465(-L)
	Plug	Socket	DK-621-0433-1S	DK-621-0434-1P	D-621-0477(-L)	D-621-0481(-L)
Standard	Jack	Pin	DK-621-0434-1P	DK-621-0433-1S	D-621-0469(-L)	D-621-0473(-L)
2.4 mm max	Jack	Socket	DK-621-0434-1S	DK-621-0433-1P	D-621-0453(-L)	D-621-0457(-L)
Long reach	Jack	Pin	DK-621-0550-1P	DK-621-0433-1S	D-621-0469(-L)	D-621-0473(-L)
12.5 mm max	Jack	Socket	DK-621-0550-1S	DK-621-0433-1P	D-621-0453(-L)	D-621-0457(-L)
Polarity B						
	Plug	Pin	DK-621-0435-2P	DK-621-0436-2S	D-621-0462(-L)	D-621-0466(-L)
	Plug	Socket	DK-621-0435-2S	DK-621-0436-2P	D-621-0478(-L)	D-621-0482(-L)
Standard	Jack	Pin	DK-621-0436-2P	DK-621-0435-2S	D-621-0470(-L)	D-621-0474(-L)
2.4 mm max	Jack	Socket	DK-621-0436-2S	DK-621-0435-2P	D-621-0454(-L)	D-621-0458(-L)
Long reach	Jack	Pin	DK-621-0448-2P	DK-621-0435-2S	D-621-0470(-L)	D-621-0467(-L)
12.5 mm max	Jack	Socket	DK-621-0448-2S	DK-621-0435-2P	D-621-0454(-L)	D-621-0483(-L)
Polarity C						
	Plug	Pin	DK-621-0437-3P	DK-621-0438-3S	D-621-0463(-L)	D-621-0467(-L)
	Plug	Socket	DK-621-0437-3S	DK-621-0438-3P	D-621-0479(-L)	D-621-0483(-L)
Standard	Jack	Pin	DK-621-0438-3P	DK-621-0437-3S	D-621-0471(-L)	D-621-0475(-L)
2.4 mm max	Jack	Socket	DK-621-0438-3S	DK-621-0437-3P	D-621-0455(-L)	D-621-0459(-L)
Long reach	Jack	Pin	DK-621-0446-3P	DK-621-0437-3S	D-621-0471(-L)	D-621-0475(-L)
12.5 mm max	Jack	Socket	DK-621-0446-3S	DK-621-0437-3P	D-621-0455(-L)	D-621-0459(-L)
Polarity D						
	Plug	Pin	DK-621-0439-4P	DK-621-0440-4S	D-621-0464(-L)	D-621-0468(-L)
	Plug	Socket	DK-621-0439-4S	DK-621-0440-4P	D-621-0480(-L)	D-621-0484(-L)
Standard	Jack	Pin	DK-621-0440-4P	DK-621-0439-4S	D-621-0472(-L)	D-621-0460(-L)
2.4 mm max	Jack	Socket	DK-621-0440-4S	DK-621-0439-4P	D-621-0456(-L)	D-621-0476(-L)
Long reach	Jack	Pin	DK-621-0551-4P	DK-621-0439-4S	D-621-0472(-L)	D-621-0460(-L)
12.5 mm max	Jack	Socket	DK-621-0551-4S	DK-621-0439-4P	D-621-0456(-L)	D-621-0476(-L)

Threaded Connectors

Polarity E						
	Plug	Pin	DK-621-0411-P	DK-621-0412-S	D-621-0406(-L)	D-621-0424(-L)
	Plug	Socket	DK-621-0411-S	DK-621-0412-P	D-621-0418(-L)	D-621-0423(-L)
Standard	Jack	Pin	DK-621-0412-P	DK-621-0411-S	D-621-0415(-L)	D-621-0407(-L)
2.4 mm max	Jack	Socket	DK-621-0412-S	DK-621-0411-P	D-621-0413(-L)	D-621-0417(-L)
Long reach	Jack	Pin	DK-621-0412-P	DK-621-0411-S	D-621-0415(-L)	D-621-0407(-L)
12.5 mm max	Jack	Socket	DK-621-0412-S	DK-621-0411-P	D-621-0413(-L)	D-621-0417(-L)



Triaxial Connectors and Terminators

European NORME EN3716 for 1553B Data Bus Cables

EN Connectors

Panel Thickness	Connector	Contact	Connector Reference	Connector	Mate with 77 Ohm Bus Terminator	3K Ohm Stub Terminator
	Plug	Pin	DK-3716-F101-TP	DK-621-E102-TS	D-621-E077-S	D-621-E03K-S
	Plug	Socket	DK-3716-F101-TS	DK-621-E102-TP	D-621-E077-P	D-621-E03K-P
	Plug	Pin	DK-3716-F201-TP	DK-621-E202-TS	D-621-E077-S	D-621-E03K-S
	Plug	Socket	DK-3716-F201-TS	DK-621-E202-TP	D-621-E077-P	D-621-E03K-P
Standard 2.4 mm max	Jack	Pin	DK-3716-E102-TP	DK-621-F101-TS	D-621-F077-S	D-621-F03K-S
	Jack	Socket	DK-3716-E102-TS	DK-621-F101-TP	D-621-F077-P	D-621-F03K-P
	Jack	Pin	DK-3716-E202-TP	DK-621-F201-TS	D-621-F077-S	D-621-F03K-S
	Jack	Socket	DK-3716-E202-TS	DK-621-F201-TP	D-621-F077-P	D-621-F03K-P
Long reach 12.5 mm max	Jack	Pin	DK-3716-E112-TP	DK-621-F101-TS	D-621-F077-S	D-621-F03K-S
	Jack	Socket	DK-3716-E112-TS	DK-621-F101-TP	D-621-F077-P	D-621-F03K-P
	Jack	Pin	DK-3716-E212-TP	DK-621-F201-TS	D-621-F077-S	D-621-F03K-S
	Jack	Socket	DK-3716-E212-TS	DK-621-F201-TP	D-621-F077-P	D-621-F03K-P

Terminators

	Connector	Contact	Terminator Reference	Standard Connector	Mate with Long Reach Connector
77 Ohm bus terminator	Plug	Pin	DK-3716-F077-P	DK-3716-E102-TS	DK-3716-E112K-TS
	Plug	Socket	DK-3716-F077-S	DK-3716-E102-TP	DK-3716-E112K-TP
	Jack	Pin	DK-3716-F077-P	DK-3716-E201-TS	
3K Ohm stub terminator	Jack	Socket	DK-3716-F077-S	DK-3716-E201-TP	
	Plug	Pin	DK-3716-E03K-P	DK-3716-E102-TS	DK-3716-E112K-TS
	Plug	Socket	DK-3716-E03K-S	DK-3716-E102-TP	DK-3716-E112K-TP
	Jack	Pin	DK-3716-E03K-P	DK-3716-E201-TS	
	Jack	Socket	DK-3716-E03K-S	DK-3716-E201-TP	

Available options include right-angle and lightweight connectors.
For more information, contact TE.



Accessories — Terminator and Connector and Compatibility

Bayonet and Threaded Connectors

Panel Thickness	Connector	Contact	Terminator Reference	Mate with	
				Standard Connector	Long Reach Connector
Bayonet Connectors					
Polarity A					
77 Ohm bus terminator	Plug	Pin	D-621-0453(-L)	DK-621-0434-1S	DK-621-0550-1S
	Plug	Socket	D-621-0469(-L)	DK-621-0434-1P	DK-621-0550-1P
	Jack	Pin	D-621-0477(-L)	DK-621-0433-1S	—
	Jack	Socket	D-621-0461(-L)	DK-621-0433-1P	—
3K Ohm stub terminator	Plug	Pin	D-621-0457(-L)	DK-621-0434-1S	DK-621-0550-1S
	Plug	Socket	D-621-0473(-L)	DK-621-0434-1P	DK-621-0550-1P
	Jack	Pin	D-621-0481(-L)	DK-621-0433-1S	—
	Jack	Socket	D-621-0465(-L)	DK-621-0433-1P	—
Polarity B					
77 Ohm bus terminator	Plug	Pin	D-621-0454(-L)	DK-621-0436-2S	DK-621-0548-2S
	Plug	Socket	D-621-0470(-L)	DK-621-0436-2P	DK-621-0548-2P
	Jack	Pin	D-621-0478(-L)	DK-621-0435-2S	—
	Jack	Socket	D-621-0462(-L)	DK-621-0435-2P	—
3K Ohm stub terminator	Plug	Pin	D-621-0458(-L)	DK-621-0436-2S	DK-621-0548-2S
	Plug	Socket	D-621-0474(-L)	DK-621-0436-2P	DK-621-0548-2P
	Jack	Pin	D-621-0482(-L)	DK-621-0435-2S	—
	Jack	Socket	D-621-0466(-L)	DK-621-0435-2P	—
Polarity C					
77 Ohm bus terminator	Plug	Pin	D-621-0455(-L)	DK-621-0438-3S	DK-621-0546-3S
	Plug	Socket	D-621-0471(-L)	DK-621-0438-3P	DK-621-0546-3P
	Jack	Pin	D-621-0479(-L)	DK-621-0437-3S	—
	Jack	Socket	D-621-0463(-L)	DK-621-0437-3P	—
3K Ohm stub terminator	Plug	Pin	D-621-0459(-L)	DK-621-0438-3S	DK-621-0546-3S
	Plug	Socket	D-621-0475(-L)	DK-621-0438-3P	DK-621-0546-3P
	Jack	Pin	D-621-0483(-L)	DK-621-0437-3S	—
	Jack	Socket	D-621-0467(-L)	DK-621-0437-3P	—
Polarity D					
77 Ohm bus terminator	Plug	Pin	D-621-0456(-L)	DK-621-0440-4S	DK-621-0551-4S
	Plug	Socket	D-621-0472(-L)	DK-621-0440-4P	DK-621-0551-4P
	Jack	Pin	D-621-0480(-L)	DK-621-0439-4S	—
	Jack	Socket	D-621-0464(-L)	DK-621-0439-4P	—
3K Ohm stub terminator	Plug	Pin	D-621-0460(-L)	DK-621-0440-4S	DK-621-0551-4S
	Plug	Socket	D-621-0476(-L)	DK-621-0440-4P	DK-621-0551-4P
	Jack	Pin	D-621-0468(-L)	DK-621-0439-4S	—
	Jack	Socket	D-621-0484(-L)	DK-621-0439-4P	—
Threaded Connectors					
77 Ohm bus terminator	Plug	Pin	D-621-0413(-L)	DK-621-0412-S	DK-621-0512-S
	Plug	Socket	D-621-0415(-L)	DK-621-0412-P	DK-621-0512-P
	Jack	Pin	D-621-0418(-L)	DK-621-0411-S	—
	Jack	Socket	D-621-0406(-L)	DK-621-0411-P	—
3K Ohm stub terminator	Plug	Pin	D-621-0417(-L)	DK-621-0412-S	DK-621-0512-S
	Plug	Socket	D-621-0407(-L)	DK-621-0412-P	DK-621-0512-P
	Jack	Pin	D-621-0423(-L)	DK-621-0411-S	—
	Jack	Socket	D-621-0424(-L)	DK-621-0411-P	—



Triaxial Contacts MIL-DTL-38999 Type

Now, both high-density packaging and full shield coverage are available with a simple, quick and reliable termination system. 24 AWG twisted-pair data bus cables are terminated to triaxial SolderTacts contacts, which fit size 8 cavities of MIL-DTL-38999, Series I, III, or IV connectors.

Raychem triaxial 38999-type data bus contacts deliver the signals.

EASY INSTALLATION

- One-step termination, requiring only 1 to 2 minutes
- No special termination tools needed
- No requirements for special skills
- **Installation Procedures:** ES-61231 and ES-612315

HIGH PERFORMANCE

- Rugged construction
- Low voltage drop and high reliability due to precisely controlled solder termination
- Triaxial mating face for least susceptibility to damage

RELIABLE

- Reworkable and repairable terminations
- Built-in strain relief
- Continuous 360° shield coverage
- Inspectable solder terminations

Size 8 triaxial data bus contacts for MIL-DTL-38999 connectors have interfaces that comply with MIL-DTL-39029/90 and /91 to provide intermatability with crimp contacts.

These contacts provide a fast and convenient method of implementing MIL-STD-1553B connections in MIL-STD-1760 applications.

Specifications/Approvals

Series	TE Connectivity
Size B	D-6020

Product Selection

Cable Type	Pin	Socket
10612	DK-602-0156-N-1	DK-602-0157-N-1
10613	DK-602-0156-N-2	DK-602-0157-N-2
10614	DK-602-0156-N-3	DK-602-0157-N-3



Data Bus Accessories

TE manufactures all of the Raychem products needed to build a MIL-STD-1553B data bus network. In addition to the main components, the following accessory components that may be necessary to complete a data bus system are also available:

- Bus and stub terminators spliced-in and connectorized (D-621 series)
- Cable splice kits
- EMI/environment-resistant connector caps
- Braid terminators and strain relief tubing for rework applications

D-621 Plug

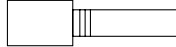

Spliced-in



D-621 Jack

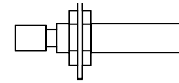

Bus and Stub Terminators

Spliced-in	12" Cable				
77-ohm 10612 cable	D-500-0463-612				
77-ohm 10613 cable	D-500-0463-613				
77-ohm 10614 cable	D-500-0463-614				
77-ohm 7724E2664 cable	D-500-0463-E26				
D-621 Series Plug	Threaded	Bayonet A	Bayonet B	Bayonet C	Bayonet D
77-ohm pin contact	D-621-0413	D-621-0453	D-621-0454	D-621-0455	D-621-0456
77-ohm socket contact	D-621-0415	D-621-0469	D-621-0470	D-621-0471	D-621-0472
3000-ohm pin contact	D-621-0417	D-621-0457	D-621-0458	D-621-0459	D-621-0476
3000-ohm socket contact	D-621-0407	D-621-0473	D-621-0474	D-621-0475	D-621-0460
D-621 Series Jack	Threaded	Bayonet A	Bayonet B	Bayonet C	Bayonet D
77-ohm pin contact	D-621-0418	D-621-0477	D-621-0478	D-621-0479	D-621-0480
77-ohm socket contact	D-621-0406	D-621-0461	D-621-0462	D-621-0463	D-621-0464
3000-ohm pin contact	D-621-0423	D-621-0481	D-621-0482	D-621-0483	D-621-0484
3000-ohm socket contact	D-621-0424	D-621-0465	D-621-0466	D-621-0467	D-621-0468
D-621 Series Lanyard	Lanyard 7"	—	—	—	—

Connector Caps



D-621 Series	Threaded	Bayonet A	Bayonet B	Bayonet C	Bayonet D
Plug cap for jack connector Supplied with 7" Lanyard	D-600-0083	D-600-0068	D-600-0068	D-600-0068	D-600-0065



Cable Splice Kits

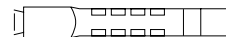

Cables	Flexible Crimp	Cable Splice Installation Procedure
All data bus cables	D-150-0708-5	RCPS-150-0

Data Bus PCB Connectors for MIL-STD-1553B Networks

Robust, Reliable PCB-Mount Data Bus Interface



RUGGED RELIABILITY

- 500-hour salt spray resistance
- Robust design for optimal electrical and mechanical performance
- Threaded coupling for optimum vibration and shock resistance

COMPATIBLE

- Mates with standard data bus cable plug connectors
- Available with pin or socket contacts

Advanced Performance for Military and Commercial Platforms

MIL-STD-1553B data bus networks have over 30 years of time-tested reliability in aerospace, military, marine, and space applications. In addition to our line of cable connectors, cable, couplers, and terminators, TE Connectivity (TE) offers a printed circuit board-mounting triaxial jack for data bus applications.

The data bus PCB jack, with socket contacts, is fully compatible with threaded data bus cable connectors. The four-leg mounting of ground leads offers robust mechanical and electrical connection to the PCB and helps withstand vibration and shock.

ENVIRONMENTAL/MECHANICAL

- **Operating Temperature:** -65°C to 125°C
- **Dielectric Strength:** 900 VAC @ 60 Hz
- **Insulation Resistance:** 5000 megohms min.
- **Current Rating:** 3 A

MATERIALS

- **Housing Body:** Beryllium copper and brass, plated tin over nickel
- **Contact Insulation:** Polyethersulfone
- **Conductor:** Tin-plated copper, 22 AWG, 0.027 diameter max.
- **Conductor Insulation:** Cross-linked PVDF
- **Ground Leads:** Brass, plated tin over nickel

SPECIFICATIONS/APPROVALS

Product Specification: D-6025

Qualification Test Report: ISTR-1408

Acceptance Test Report: ISTR-1365

	Part No.		
	Description	Contact	Mating Connector
Socket Assembly	DK-621-0012-SM	D-602-0127	DK-621-0011-P
Pin Assembly	DK-621-0012-PM	D-602-0126	DK-621-0011-S



Data Bus PCB Connectors for MIL-STD-1553B Networks

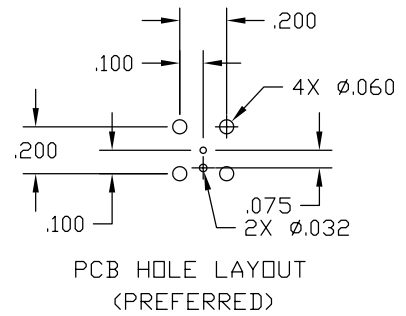
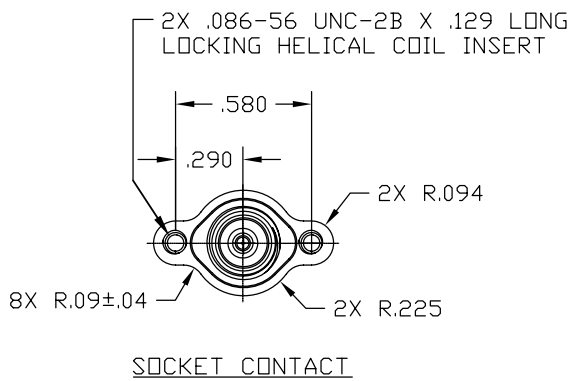
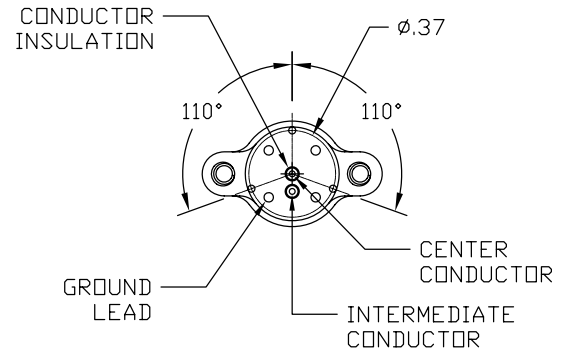
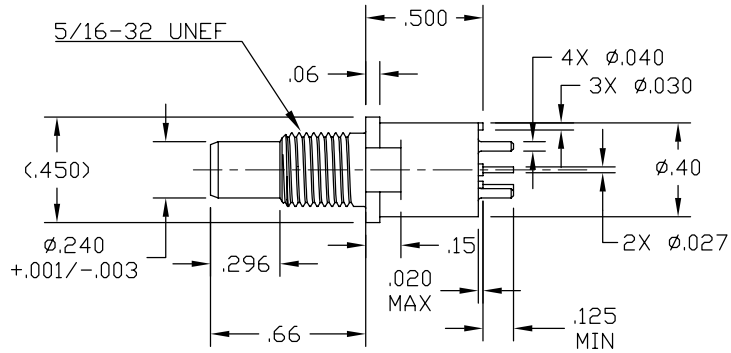

Space-Grade MIL-STD-1553B Data Bus Components

A Complete System of Interconnection Hardware



Description

A complete system of interconnection hardware for MIL-STD-1553B networks.

Complete collection of components include:

- A wide selection of couplers such as micros, boxes, flat-packs, and ultra-lightweight versions
- Data bus cables
- Triax connectors and contacts with strain relief
- One-piece triaxial contacts for MIL-DTL-38999 connectors
- Bus and stub terminators
- Low outgassing components for use in space
- Cable identification sleeves
- Harness design using HARNWARE software
- Flexible cable splices



APPLICATIONS

- Used in MIL-STD-1553B multiplexing space applications
- Flight control for:
 - Launch Vehicles
 - Satellites
 - Human Spacecraft
 - Cargo Spacecraft
 - Deep Space Probes

SPECIFICATION

Meets TE Specification D-6022 for space-grade data bus components.

MORE CHOICE

- Complete line of space-qualified MIL-STD-1553B components
- Wide selection of couplers
- Design flexibility

RUGGED RELIABILITY

- High packaging density and weight savings
- Low outgassing levels that meet NASA requirements
- Rugged construction

COMPLETE HARNESS SYSTEMS

- Factory-built harnesses eliminate unnecessary splices and connectors
- Pre-tested to customer requirements and ready for installation
- Reduced cost and increased network reliability



Space-Grade MIL-STD-1553B Data Bus Components

Components



In-Line Couplers and Terminators

- Tin/nickel-plated metallic parts
- Baked silicone rubber components
- Low outgassing tubing
- D-500-94XX-X-XXX series for couplers
- D-500-9463-XXX series for terminators



Threaded Triaxial Connectors

- Tin/nickel-plated metallic parts
- Baked silicone rubber components
- Low outgassing tubing
- DK-621-0911P
- DK-621-0911S
- DK-621-0912P
- DK-621-0912S



Bayonet Triaxial Connectors

- Tin/nickel-plated metallic parts
- Baked silicone rubber components
- Low outgassing tubing

“A” Polarization

- DK-621-0933-1P or S
- DK-621-0934-1P or S

“B” Polarization

- DK-621-0935-2P or S
- DK-621-0936-2P or S

“C” Polarization

- DK-621-0937-3P or S
- DK-621-0938-3P or S

“D” Polarization

- DK-621-0939-4P or S
- DK-621-0940-4P or S



Splice Kits

- Flux-coated, solder-impregnated copper shield braid encased in a transparent heat-shrinkable insulation sleeve provides a controlled soldering process, encapsulation, inspectability, strain relief and insulation
- DK-150-9708-5



Standard Space Cables

- Single- or double-braid shield—with optional mumetal layer for EMP hardening—and radiation crosslinked ETFE insulation and jacket for low outgassing

Optimized Single Shield

- S16 = 7724S1664-9

- S1L = 7724S1LL4 LF*

EMP Hardened

- S86 = 7724S8664-9
- S8L = 7724S8LL4-9 LF

Optimized Double Shield

- S36 = 7724S3664-9
- S3L = 7724S3LL4 LF

*LF = Low Fluoride



Demateable Terminators

- Available with and without lanyard
- DK-621-0937
- DK-621-0938
- DK-621-0939
- DK-621-0940
- DK-621-0933
- DK-621-0934
- DK-621-0935
- DK-621-0936

TE also manufactures complete harnesses to customer specifications and print.



Space-Grade MIL-STD-1553B Data Bus Components

Space-Grade In-Line Coupler Part Numbering

D-500-94 W W - X - YYY ZZZ

STYLE

- 5** Without Mounting Eyelet
- 6** With Mounting Eyelet

DESIGN

- 5** Without Internal Terminator
- 6** Same as 5 but with Reverse Bus
- 7** With Internal Terminator
- 8** Same as 7 but with Reverse Bus

NUMBER OF STUBS

1, 2, 3, or 4

CABLE TYPE

- 41L** 7724S1LL4 (24 AWG Single Optimized Shield)
- 43L** 7724S3LL4 (24 AWG Double Optimized Shield)
- 48L** 7724S8LL4 (24 AWG EMP Hardened)

CABLE LENGTH

- 012** 12 In (1 Ft)
- 078** 78 In (6.5 Ft)
- 079** 79 In (2 m)
- 120** 120 In (10 Ft)
- 236** 236 In (6 m)
- 240** 240 In (20 Ft)



Space-Grade MIL-STD-1553B Data Bus Components

Space-Grade Connectors Part Numbering

DK-621 - 09 XX - X X

D-621 CONNECTOR, KITTED WITH ACCESSORIES

BASIC CONNECTOR CONFIGURATIONS

Threaded Styles

- 11** Plug
- 12** Jack

Bayonet Styles

- 33** Plug, A Polarization
- 34** Jack, A Polarization
- 35** Plug, B Polarization
- 36** Jack, B Polarization
- 37** Plug, C Polarization
- 38** Jack, C Polarization
- 39** Plug, D Polarization
- 40** Jack, D Polarization

POLARIZATION (BAYONET STYLES ONLY) (JACK VIEW)

1 = A



2 = B



3 = C



4 = D



CONTACT (INSTALLED, DK-621 KITS ONLY)

- P** Pin*
- S** Socket*

*May be ordered separately as D-602-0126 (pin) and D-602-0127 (socket)

Space-Grade Terminators Part Numbering

D-500-9463- ZZZ

CABLE TYPE

- 41L** 7724S1LL4 (24 AWG Single Optimized Shield)
- 43L** 7724S3LL4 (24 AWG Double Optimized Shield)
- 48L** 7724S8LL4 (24 AWG EMP Hardened)

Space-Grade Splice Kit: **D-150-9708-5**



Customer-Specified Harness Assemblies and HARNWARE Harness Design Software

TE supplies complete Raychem brand data bus networks in accordance with customer harness drawings, with any customer-specified cables and/or connectors. Using factory-built harnesses eliminates unnecessary splices and connectors, reducing the cost and increasing the reliability of the networks.

Factory built harnesses are pre-tested and ready for installation. HARNWARE Harness Design Software allows designers to draw a data bus harness in a matter of minutes, while selecting TE or others' components; a bill of materials is automatically generated.





Sample Drawing

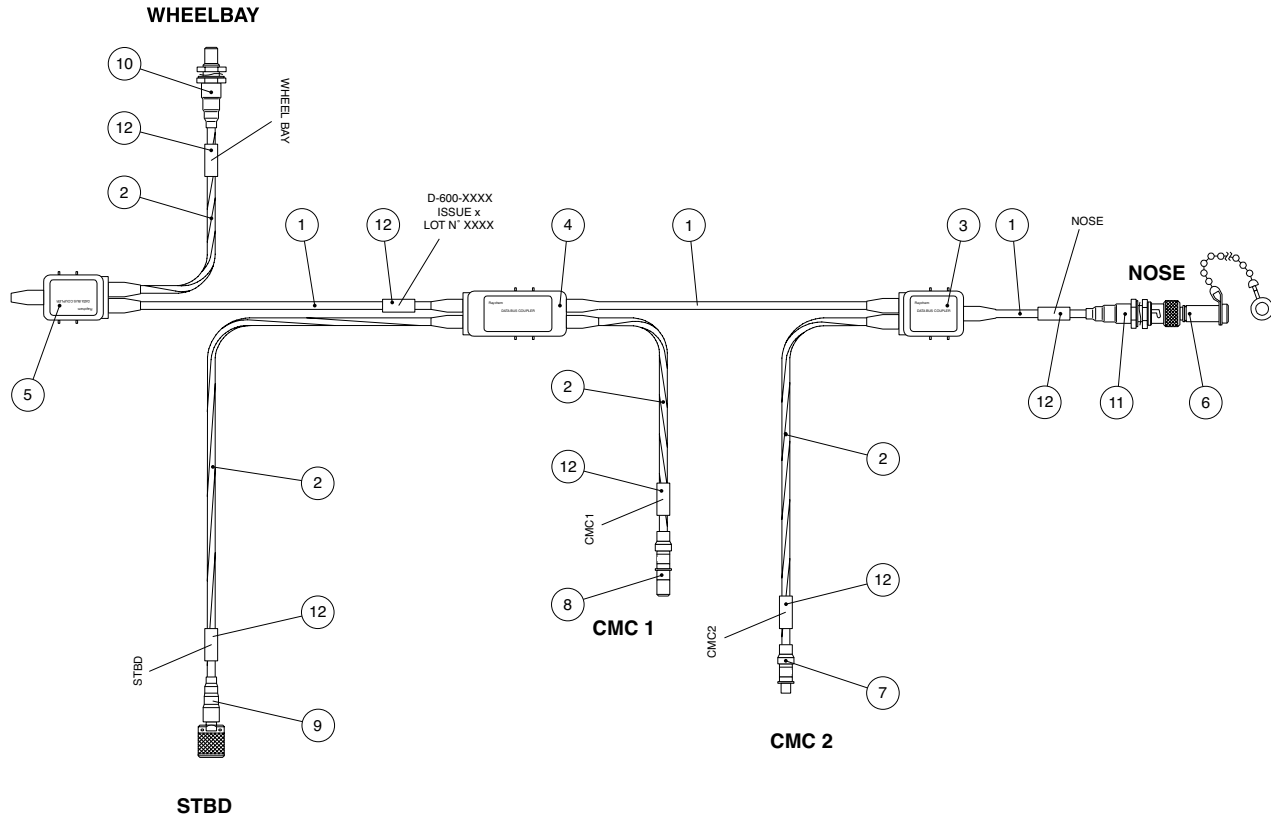

Parts List

Item	Description	Part No.	Spec/Remarks	Qty	Unit
1	Data Bus Cable	10613-9	TE	5.3	M
2	Data Bus Cable	10613-96	TE	7	M
3	Data Bus Coupler	D-500-0455-1	TE	1	Pc
4	Data Bus Coupler	D-500-0455-2	TE	1	Pc
5	Data Bus Coupler	D-500-0457-1	TE	1	Pc
6	Data Bus Terminator	D-621-0469-L	TE	1	Pc
7	Data Bus Contact	DK-602-0156-N-2	TE	1	Pc
8	Data Bus Contact	DK-602-0157-N-2	TE	1	Pc
9	Data Bus Connector	DK-621-0411-P	TE	1	Pc
10	Data Bus Connector	DK-621-0412-P	TE	1	Pc
11	Data Bus Connector	DK-621-0434-1P	TE	1	Pc
12	Market Sleeve	TMS-SCE-3/16-2.0-9	TE	6	Pc

LET'S CONNECT

We make it easy to connect with our experts and are ready to provide all the support you need. Just call your local support number or visit www.te.com to chat with a Product Information Specialist.

Technical Support

te.com/support-center

North America	+1 800 522 6752	Asia Pacific	+86 400 820 6015
North America (Toll)	+1 717 986 7777	Japan	+81 044 844 8180
EMEA/South Africa	+800 0440 5100	Australia	+61 2 9554 2695
EMEA (Toll)	+31 73 624 6999	New Zealand	+64 (0) 9 634 4580
India (Toll-Free)	+800 440 5100		

te.com/databus

AMP, AGASTAT, CII, DEUTSCH, HARNWARE, HARTMAN, KILOVAC, LL Rowe, MICRODOT, MiniSeal, NANONICS, POLAMCO, Raychem, SEACON, SolderShield, SolderTacts, SPEC 55, TE, TE Connectivity and the TE connectivity (logo) are trademarks of the TE Connectivity Ltd. family of companies. Other products, logos, and company names mentioned herein may be trademarks of their respective owners.

While TE Connectivity (TE) has made every reasonable effort to ensure the accuracy of the information herein, nothing herein constitutes any guarantee that such information is error-free, or any other representation, warranty or guarantee that the information is accurate, correct, reliable or current. The TE entity issuing this publication reserves the right to make any adjustments to the information contained herein at any time without notice. All implied warranties regarding the information contained herein, including, but not limited to, any implied warranties of merchantability or fitness for a particular purpose are expressly disclaimed. The dimensions herein are for reference purposes only and are subject to change without notice. Specifications are subject to change without notice.

Consult TE for the latest dimensions and design specifications.

© 2017 TE Connectivity Ltd. family of companies All Rights Reserved.

1773030 03/17

X-ON Electronics

Largest Supplier of Electrical and Electronic Components

Click to view similar products for [Wire Labels & Markers](#) category:

Click to view products by [TE Connectivity](#) manufacturer:

Other Similar products are found below :

[89078GBEST](#) [89082GBESR](#) [89082GBEST](#) [PCL025-4](#) [5761-2SF](#) [58400](#) [M1.040.0000.6](#) [CRS-CM5M](#) [CRS-M18M](#) [CS1836-000](#) [CS8626-000](#) [CU6337-000](#) [CU6342-000](#) [CU6343-000](#) [CWD01-0](#) [CWD012-0](#) [CWD012-7](#) [CWD015-3](#) [CWD015-7](#) [CWD02-0](#) [CWD02-3](#) [CWD02-4](#) [CWD02-6](#) [CWD02-8](#) [CWD02-A](#) [CWD02-D](#) [CWD02-H](#) [CWD02-K](#) [CWD02-L](#) [CWD02-M](#) [CWD02-P](#) [CWD02-Q](#) [CWD02-R](#) [CWD02-U](#) [CWD02-W](#) [CWD02-Y](#) [CWD03-+](#) [CWD03-0](#) [CWD03-P](#) [CWD06-0](#) [CWD06-8](#) [CWD06-9](#) [CWD06-L](#) [CWD06-N](#) [CWD09-0](#) [CWD09-5](#) [CWD09-7](#) [6806810001](#) [CZ2857-000](#) [6V1J0](#)