

SCALA NON IMPEGNATIVA
(DO NOT SCALE)
DIMENSIONI IN mm
(DIMENSIONS IN)

METRIC

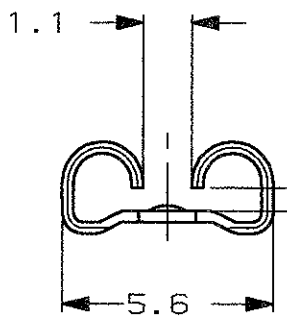

ADATTO PER LINGUETTA DI 0.8 mm
(TO FIT TAB 0.8 mm THK.)

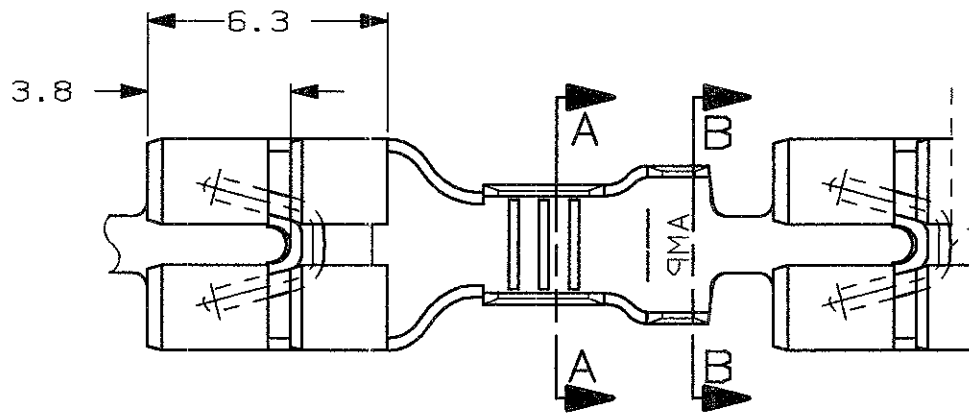
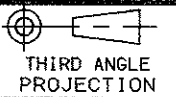
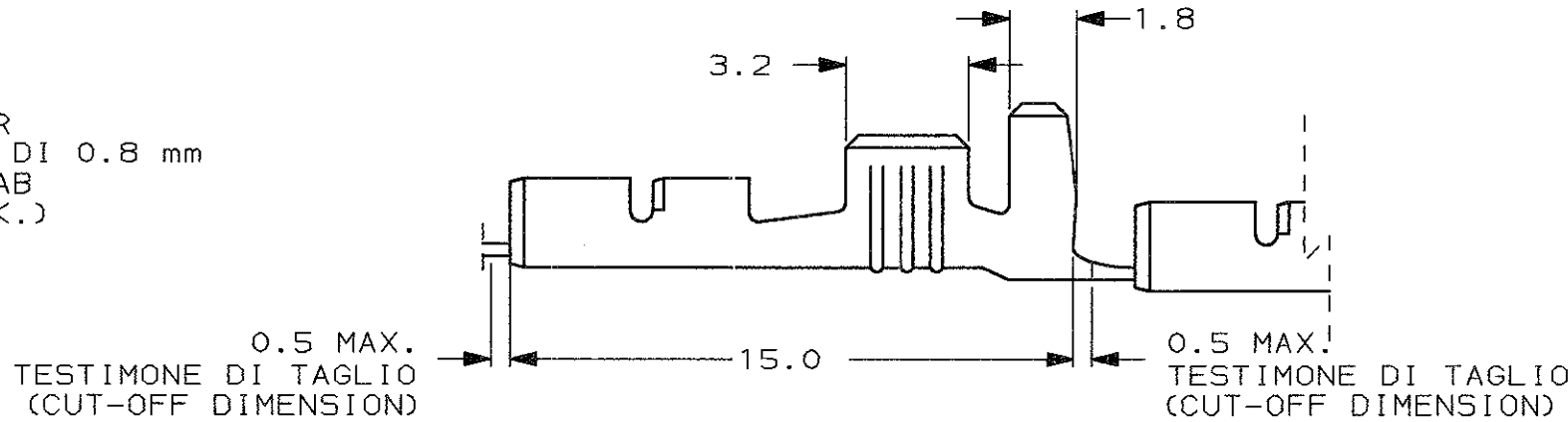

SEZIONE B-B
(SECTION B-B)

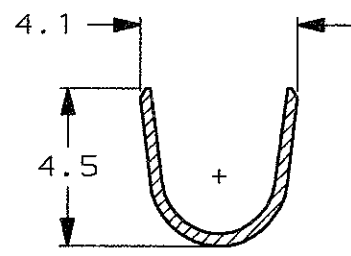

SEZIONE A-A
(SECTION A-A)

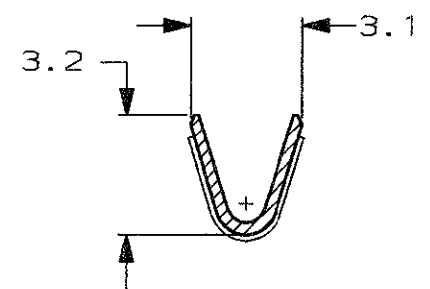

4 OBSOLETE PARTS: OBSOLETE CIS STREAMLINING PER D.RENAUD/D.SINISI

4 OBSOLETE	STAGNATO (TIN PLATED)	BRONZO FOSF. (PHOS. BRONZE)	0-100494-4	E
	STAGNATO (TIN PLATED)	OTTONE (BRASS)	0-100494-2	E
	FINITURA / COLORE (FINISH / COLOUR)	MATERIALE (MATERIAL)	NUMERO (PART NUMBER)	REV

CUSTOMER DWG. FOR REFERENCE ONLY DISEGNO PER CLIENTE SOLO PER RIFERIMENTO

THIS DRAWING IS UNPUBLISHED RELEASE FOR PUBLICATION 19

TOLLERANZE, SE NON DIVERSAMENTE SPECIFICATO (TOLERANCES, UNLESS OTHERWISE SPECIFIED)	DIAM. ISOLANTE (INS. DIA. RANGE) mm	RANGO FILO (WIRE RANGE) mm ²	SCALA (SCALE)
± 0.3	2.3-3.3 DIA.	0.5-1.5	5:1

ANGOLI (ANGLES) ± 2°

TE TE Connectivity

DIS. H. YAALI (DR.) 30 MAR 2000 DESCRIZIONE (DESCRIPTION) FASTON® Connector, .187" sr. L.I.F. REC. CONTACT.

CONT. C. TARTARI (CHK) 30 MAR 2000 LOC. SIZE NUMERO (DWG NO) I A3 C-100494 REV. E3 FOGLIO (SHEET) 1 OF 1

1) STATO DI FORNITURA SCALA 1:1 (SUPPLY CONDITION SCALE 1:1)

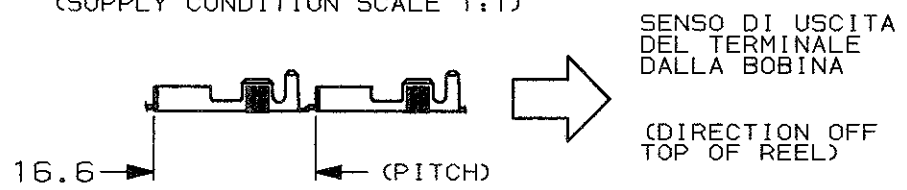

- 2) SPECIFICA DI PRODOTTO 108-19077 (PRODUCT SPEC. 108-19077)
- 3) SPECIFICA DI AGGRAFFATURA 114-20081 (APPLICATION SPEC. 114-20081)

E3	REVISED PER ECO-11-005140	RK	31MAR11
REV. (REV. LTR.)	REVISIONI (REVISION RECORD)	DIS. (DR)	DATA (DATE)

DISTRIBUZIONE (PRINT/DIST.)

X-ON Electronics

Largest Supplier of Electrical and Electronic Components

Click to view similar products for [Terminals](#) category:

Click to view products by [TE Connectivity](#) manufacturer:

Other Similar products are found below :

[00-054007-01074-6](#) [00-054007-70206-1](#) [00-054007-70210-8](#) [00-054007-70217-7](#) [00-054007-70226-9](#) [00-054007-70228-3](#) [00-054007-70248-1](#) [00-054007-70256-6](#) [00-054007-70301-3](#) [00-054007-70316-7](#) [00-054007-49560-4](#) [00-054007-70209-2](#) [00-054007-70225-2](#) [00-054007-70227-6](#) [00-054007-70231-3](#) [00-054007-70241-2](#) [00-054007-70242-9](#) [00-054007-70244-3](#) [00-054007-70246-7](#) [00-054007-70263-4](#) [00-054007-70288-7](#) [00-054007-70290-0](#) [00-054007-70300-6](#) [00-054007-70304-4](#) [01-2065-1-0216](#) [01-2900-1-04412](#) [00581P0075](#) [600TS-10](#) [60205-1](#) [604200-1](#) [605601-1](#) [60598-1-CUT-TAPE](#) [61314-6-C](#) [61810-3](#) [61-S](#) [61-SN](#) [626-0194](#) [62-NBM-A](#) [62-SN](#) [62-SP](#) [63-S](#) [640179-1](#) [M55155/059I03](#) [M55155/079C01](#) [M55155/099H02](#) [M55155/109H01](#) [M55155/109H02](#) [M55155/12XH05](#) [M55155/16XH02](#) [M55155/29-5S](#)