

REV  
NC 1011-052  
055 -1205

REVISIONS			
SYM	DESCRIPTION	DATE	APPROVED
NC	NEW RELEASE PER E.O. P18260	8-22-03	ADR

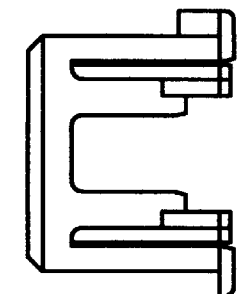

VIEW SHOWS KEY -A- AS REFERENCE.

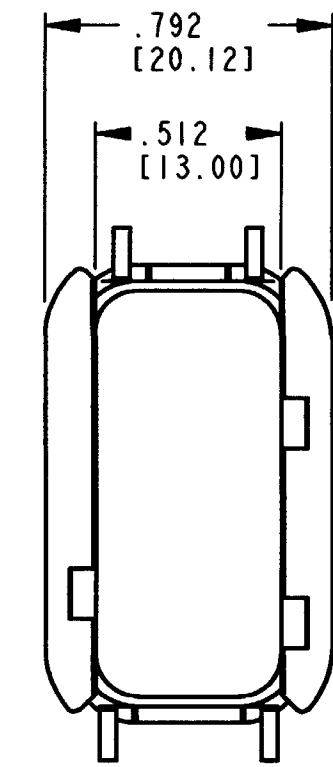
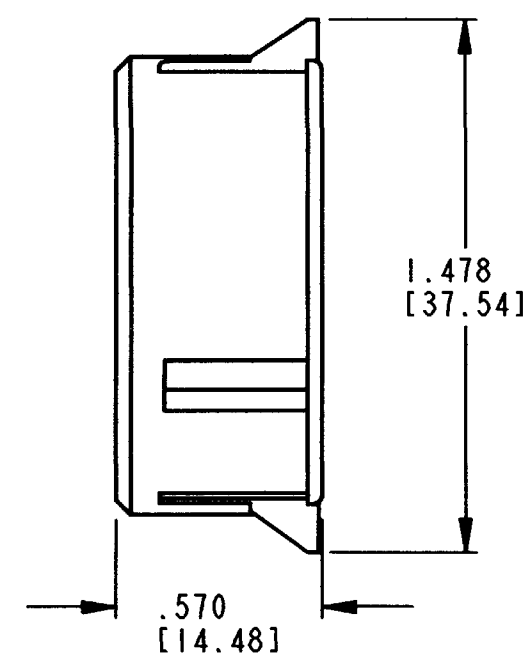

- 6. SEE NEXT SHEET FOR COLOR OF MATERIAL AND KEY ARRANGEMENT.
  - 5. ASSEMBLE SLEEVE RETAINER AS SHOWN. SNAP SLEEVE RETAINER INTO RECEPTACLE. VERIFY SLEEVE RETAINER RETENTION FINGERS ARE FULLY SEATED BEHIND RECEPTACLE LATCH BUMPS. RECEPTACLE AND INTERFACE SEAL SHOWN FOR REFERENCE ONLY.
  - 4. MATERIAL: PLASTIC
  - 3. PART DESIGNED TO FIT DTM04-12P\*-\*\*\*\* (\* = A,B,C,D KEYS) (\*\*\*\* = ALL MODIFICATIONS). CONSULT FACTORY FOR MODIFICATIONS.
  - 2. DIMENSIONS ARE ±.025 [.64]
  - 1. DIMENSIONS ARE IN INCHES [mm]
- NOTES: UNLESS OTHERWISE SPECIFIED

SIGNATURE & DATE	
DR	V. TOMSA AUG-8-03.
CHK	B. Byford 8/19/03
PE	Vladimir Tomsa 8/11/03
APPD	D. Meyer 8/12/03
SCALE	NONE

SLEEVE RETAINER FOR 12 PIN RECEPTACLE DTM SERIES

ENVELOPE

CP	MATL. CODE
<b>The Deutch Company</b> DEUTSCH I.P.D. 3850 INDUSTRIAL AVE. HEMET, CALIF. 92545	
<b>B</b>	1011-052 -1205
DWG SIZE 11139	SHEET 1 OF 2

REV  
NC 1011-052-1205  
055

REVISIONS			
SYM	DESCRIPTION	DATE	APPROVED
	SEE PREVIOUS SHEET.	8-22-03	RDR

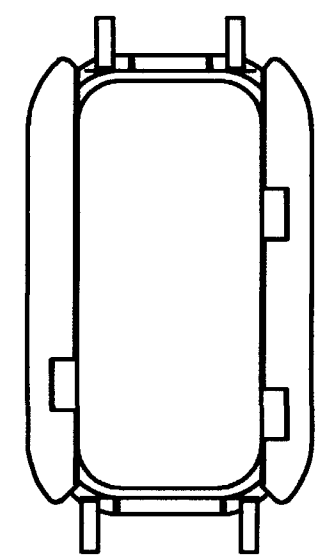

1011-052-1205  
KEY -A-  
GREY

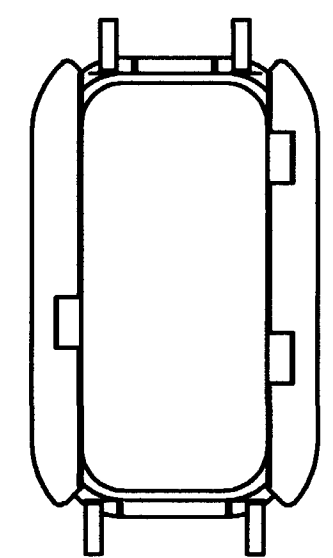

1011-053-1205  
KEY -B-  
BLACK

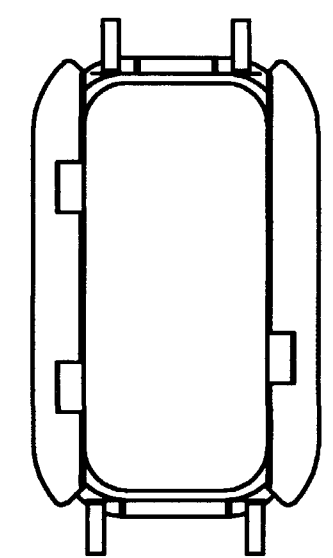

1011-054-1205  
KEY -C-  
GREEN

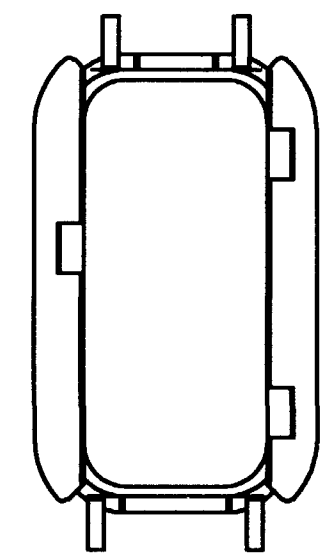

1011-055-1205  
KEY -D-  
BROWN

NOTES:

SIGNATURE & DATE	
DR	V. TOMSA AUG-8-03.
CHK	B. Byrd 8/19/03
PE	Vladimir Tomsa 8/11-03
APPD	D Meyer 8/12/03
SCALE	1:1

SLEEVE RETAINER  
FOR 12 PIN RECEPTACLE  
DTM SERIES

ENVELOPE

CP	MATL. CODE
<b>The Deutsch Company</b> DEUTSCH I.P.D. 3850 INDUSTRIAL AVE. HEMET, CALIF. 92545	
<b>B</b>	1011-052-1205 055
DWG SIZE	CODE 11139 SHEET 2 OF 2

## X-ON Electronics

Largest Supplier of Electrical and Electronic Components

*Click to view similar products for [Automotive Connectors](#) category:*

*Click to view products by [TE Connectivity](#) manufacturer:*

Other Similar products are found below :

[003-018-000](#) [60403001](#) [60993906-B](#) [M902-2131](#) [M902-2161](#) [72.330.1035.1](#) [73.353.4028.0](#) [F119300-B](#) [F166900](#) [F258300-B](#) [F358300-B](#)  
[F407400](#) [F444110](#) [F487000](#) [F509500B-B](#) [827153-1](#) [8N1515-32-24P](#) [9-1326729-8](#) [925474-1](#) [928905-1](#) [964562-4](#) [968782-1](#) [GT17SA-8DS-](#)  
[HU](#) [98891-1012](#) [98947-1016](#) [12004147](#) [12004475-L](#) [12010290](#) [12010309-B](#) [12015454](#) [12020219-B](#) [12020308](#) [12041318-B](#) [12052225-L](#)  
[12052466](#) [12059125](#) [12064869](#) [12004327-B](#) [12010503-B](#) [12015308](#) [12015384](#) [12015909](#) [1-21030-1](#) [12041254](#) [12041318](#) [12047946-B](#)  
[12047957](#) [12047957-L](#) [12059473](#) [12066261](#)