

THIS DRAWING IS UNPUBLISHED. RELEASED FOR PUBLICATION 20  
 © COPYRIGHT 20 BY - ALL RIGHTS RESERVED.

REVISIONS					
P	LTR	DESCRIPTION	DATE	DWN	APVD
	N	REDRAWN/REVISED PER ECO-17-001757	11NOV2017	GR	JO

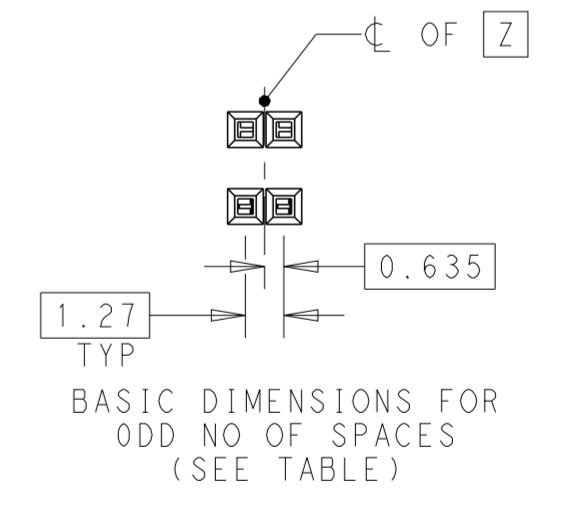
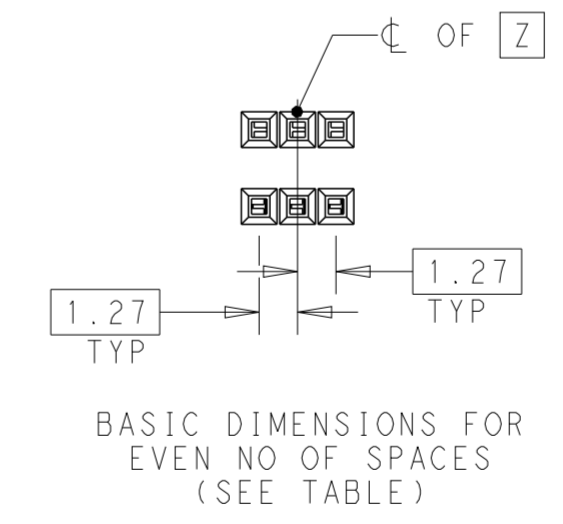
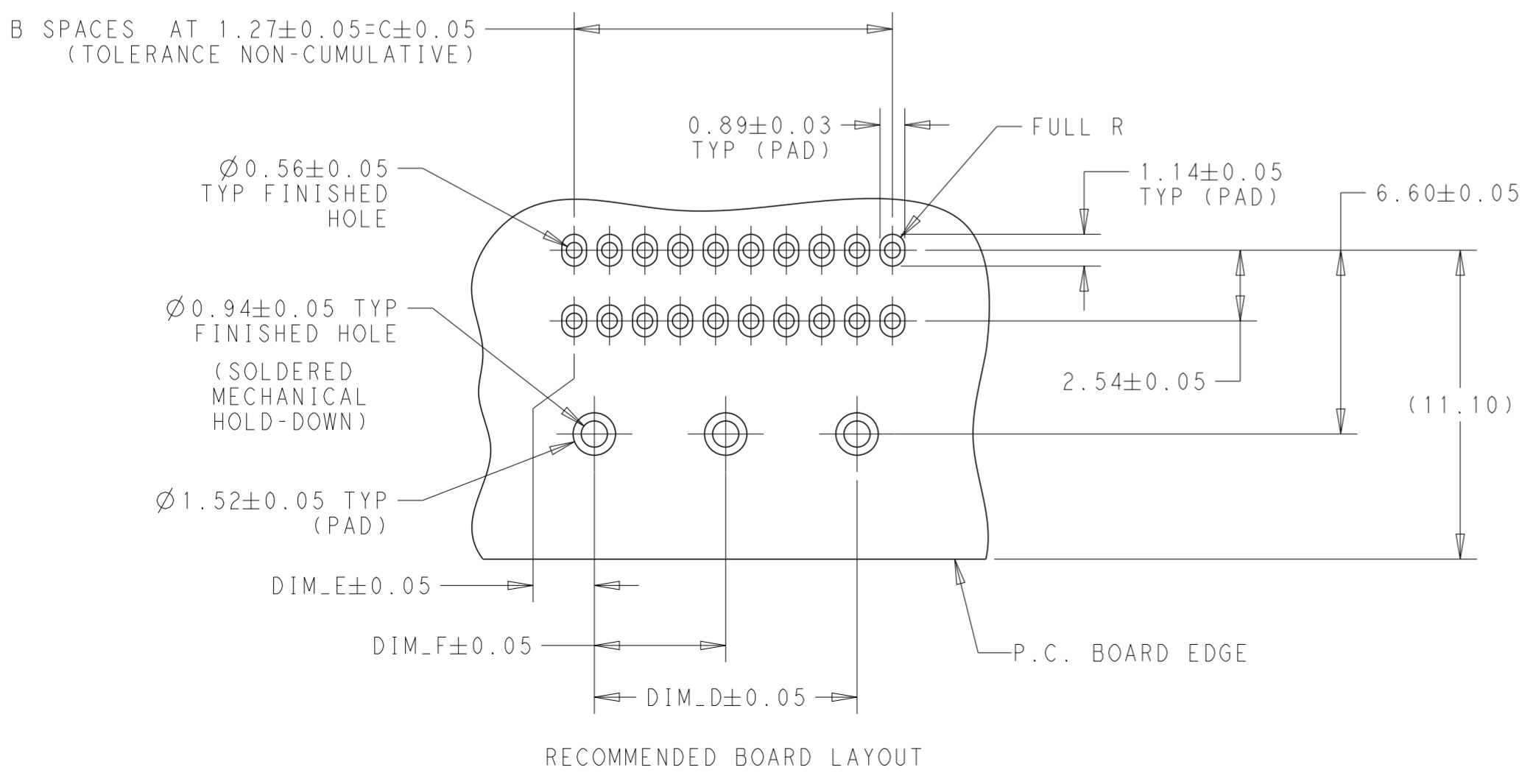
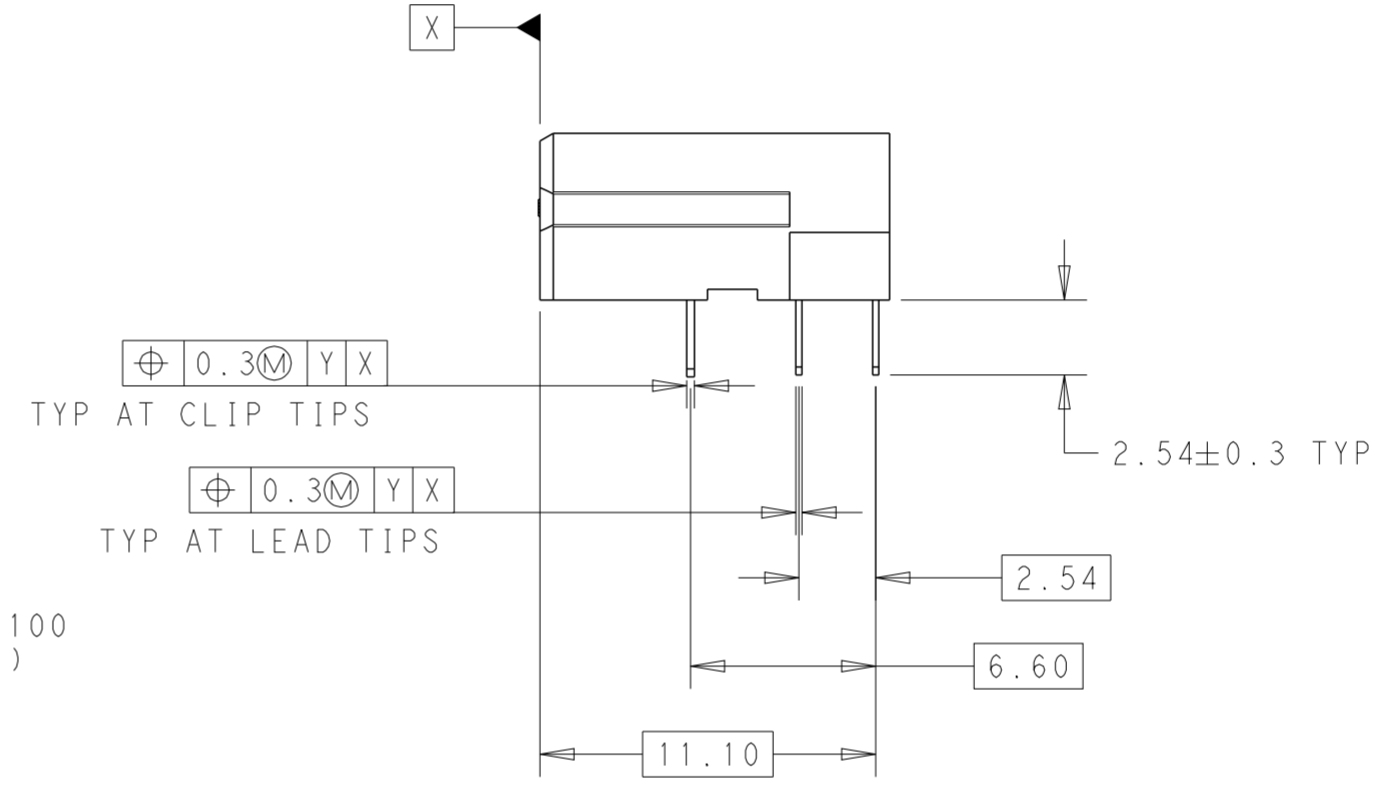
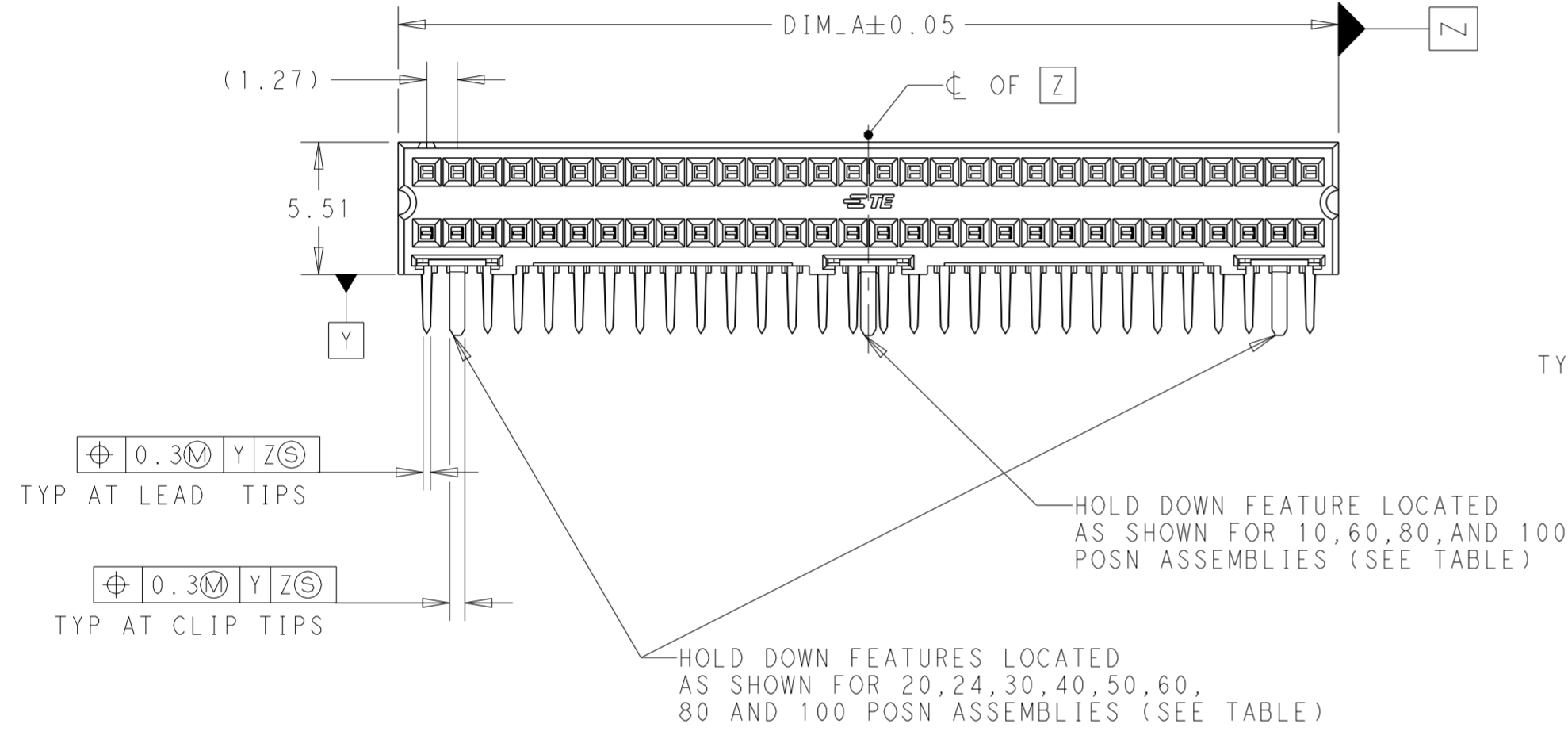
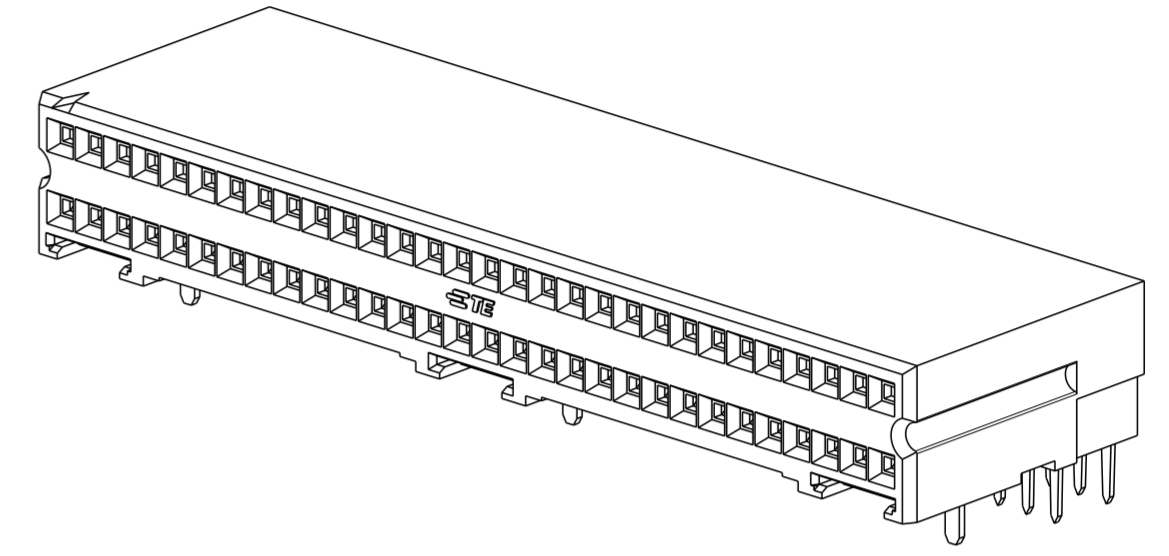
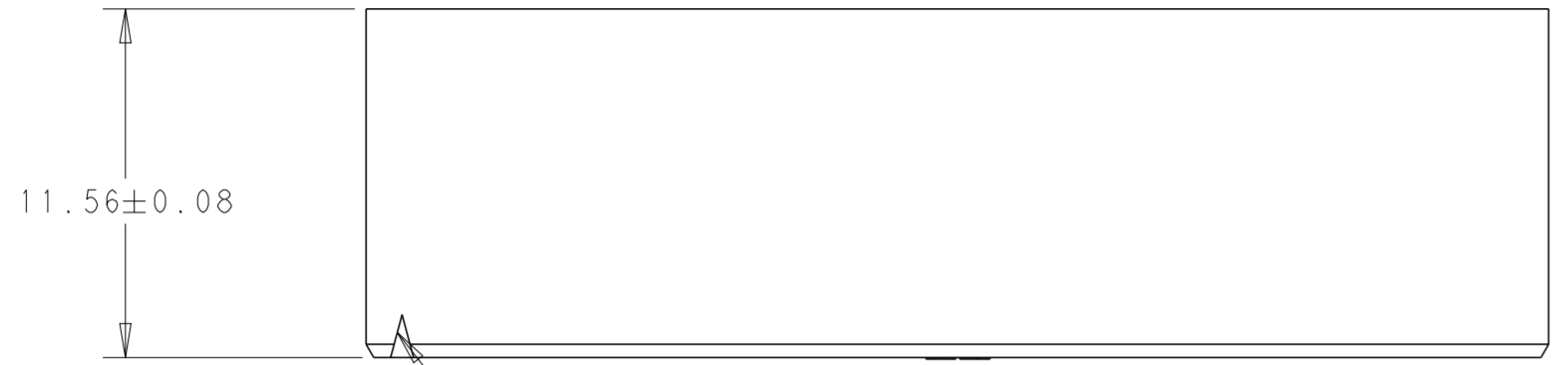

THIS DRAWING IS A CONTROLLED DOCUMENT.		DWN G. RAMESH 11NOV2017	TE Connectivity		
DIMENSIONS: mm		CHK J. OLSON 11NOV2017			
TOLERANCES UNLESS OTHERWISE SPECIFIED:		APVD J. OLSON 11NOV2017	NAME RECEPTACLE ASSEMBLY, RIGHT ANGLE, AMPMODU SYSTEM 50		
0 PLC ±	1 PLC ±0.3	PRODUCT SPEC 108-1093	SIZE CAGE CODE DRAWING NO RESTRICTED TO		
2 PLC ±0.13	3 PLC ±	APPLICATION SPEC 114-25031	A200779 C-103911		
4 PLC ±	ANGLES ±0.5°	WEIGHT -	SCALE 4:1 SHEET 1 OF 2 REV N		
MATERIAL - 3	FINISH -	CUSTOMER DRAWING			
SEE TABLE					

THIS DRAWING IS UNPUBLISHED. RELEASED FOR PUBLICATION 20  
 © COPYRIGHT 20 BY - ALL RIGHTS RESERVED.

REVISIONS				
P	LTR	DESCRIPTION	DATE	APVD
-	-	SEE SHEET 1	-	-

- 1 CONTACT AREA PLATED WITH 0.76µm GOLD;  
SOLDER CLIPS AND LEADS PLATED WITH 3.81µm TIN-LEAD,  
ALL OVER 1.27µm NICKEL
- 2 NOTE DELETED.
- 3 HOUSING: LCP, COLOR-BLACK.  
CONTACT: COPPER ALLOY.  
SOLDER CLIP: PHOSPHOR BRONZE
- 4 CONTACT AREA PLATED WITH 0.76µm GOLD;  
SOLDER CLIPS AND LEADS PLATED WITH 3.81µm TIN ALL OVER 1.27µm
- 5 NOTE DELETED.
- 6 ROHS 2002/95/EC COMPLIANT
- 7 FINISH: 0.03µm MIN.GOLD ON GOLD PLATED AREA, 3.81µm  
MATTE TIN LEAD ON PLATE AREA, UNDER PLATING SHOULD BE 1.27µm  
NICKEL ON ENTIRE CONTACT.
- 8 NOTE DELETED.
- 9 NOTE DELETED.
- 10 NOTE DELETED.
- 11 FINISH: 0.03µm MIN.GOLD ON GOLD PLATED AREA, 3.81µm  
MATTE TIN ON TIN PLATED AREA, UNDER PLATING SHOULD BE 1.27µm  
NICKEL ON ENTIRE CONTACT

11 6	-	1.27	11.43	13.97	11	16.36	24	7-103911-9
	29.85	1.27	59.69	62.23	49	64.62	100	7-103911-8
	-	1.27	15.24	17.78	14	20.17	30	7-103911-7
	23.5	1.27	46.99	49.53	39	51.92	80	7-103911-6
	-	1.27	21.59	24.13	19	26.52	40	7-103911-5
	-	1.27	27.94	30.48	24	32.87	50	7-103911-4
	17.15	1.27	34.29	36.83	29	39.22	60	7-103911-3
	-	1.27	8.89	11.43	9	13.82	20	7-103911-2
-	2.54	-	5.08	4	7.47	10	7-103911-1	
4 6	-	1.27	11.43	13.97	11	16.36	24	5-103911-9
	29.85	1.27	59.69	62.23	49	64.62	100	5-103911-8
	-	1.27	15.24	17.78	14	20.17	30	5-103911-7
	23.5	1.27	46.99	49.53	39	51.92	80	5-103911-6
	-	1.27	21.59	24.13	19	26.52	40	5-103911-5
	-	1.27	27.94	30.48	24	32.87	50	5-103911-4
	17.15	1.27	34.29	36.83	29	39.22	60	5-103911-3
	-	1.27	8.89	11.43	9	13.82	20	5-103911-2
-	2.54	-	5.08	4	7.47	10	5-103911-1	
FINISH	DIM_F	DIM_E	DIM_D	DIM_C	B SPACES	DIM_A	NO OF POSN	PART NUMBER

7	-	1.27	11.43	13.97	11	16.36	24	2-103911-9
	29.85	1.27	59.69	62.23	49	64.62	100	2-103911-8
	-	1.27	15.24	17.78	14	20.17	30	2-103911-7
	23.5	1.27	46.99	49.53	39	51.92	80	2-103911-6
	-	1.27	21.59	24.13	19	26.52	40	2-103911-5
	-	1.27	27.94	30.48	24	32.87	50	2-103911-4
	17.15	1.27	34.29	36.83	29	39.22	60	2-103911-3
	-	1.27	8.89	11.43	9	13.82	20	2-103911-2
-	2.54	-	5.08	4	7.47	10	2-103911-1	
1	-	1.27	11.43	13.97	11	16.36	24	103911-9
	29.85	1.27	59.69	62.23	49	64.62	100	103911-8
	-	1.27	15.24	17.78	14	20.17	30	103911-7
	23.5	1.27	46.99	49.53	39	51.92	80	103911-6
	-	1.27	21.59	24.13	19	26.52	40	103911-5
	-	1.27	27.94	30.48	24	32.87	50	103911-4
	17.15	1.27	34.29	36.83	29	39.22	60	103911-3
	-	1.27	8.89	11.43	9	13.82	20	103911-2
-	2.54	-	5.08	4	7.47	10	103911-1	
FINISH	DIM_F	DIM_E	DIM_D	DIM_C	B SPACES	DIM_A	NO OF POSN	PART NUMBER

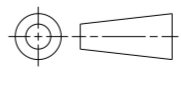
THIS DRAWING IS A CONTROLLED DOCUMENT.		DWN G. RAMESH 11NOV2017	 TE Connectivity
DIMENSIONS: mm		CHK J. OLSON 11NOV2017	
TOLERANCES UNLESS OTHERWISE SPECIFIED:		APVD J. OLSON 11NOV2017	
		PRODUCT SPEC 108-1093	
MATERIAL		APPLICATION SPEC 114-25031	NAME RECEPTACLE ASSEMBLY, RIGHT ANGLE, AMPMODU SYSTEM 50
SEE TABLE		WEIGHT	SIZE A2
		CUSTOMER DRAWING	CAGE CODE 00779
		SCALE 4:1	DRAWING NO C-103911
		SHEET 2 OF 2	RESTRICTED TO -
		REV N	

## X-ON Electronics

Largest Supplier of Electrical and Electronic Components

*Click to view similar products for [Board to Board & Mezzanine Connectors](#) category:*

*Click to view products by [TE Connectivity](#) manufacturer:*

Other Similar products are found below :

[589158040000018](#) [MDF7C-18P-2.54DSA\(55\)](#) [FCN-230C068-11](#) [FCN-268F012-G/BD](#) [FCN-268F036-G/BD](#) [FCN-268M012-G/0D](#) [FCN-268M024-G/1D](#) [FCN-723J004/1](#) [MIS-048-01-F-D-DP-K](#) [832-10-034-10-001000](#) [FX4C-80S-1.27DSA](#) [FCN-214Q030-G/0](#) [FCN-234P048-G/0](#) [FCN-235D050-G/C](#) [210-93-314-41-105000](#) [2-22603-0](#) [MDF7-40DP-2.54DSA\(55\)](#) [AXG720047](#) [5031084030](#) [MIT-114-03-F-D-K](#) [55323-1519](#) [DF33-2P-3.3DSA\(24\)](#) [YFT-20-05-H-03-SB-K](#) [503308-3040](#) [026-6203-PDB](#) [027-6203-PDB](#) [069159702701000](#) [10123981-102LF](#) [101A10019X](#) [55650-0588-C](#) [68682-310LF](#) [68684-306](#) [75140-7012](#) [87471-650](#) [194261-1](#) [FCN-268F024-G0D](#) [10124054-515LF](#) [68685-603](#) [8-1616154-3](#) [MIS-019-01-F-D](#) [FCN-268M024-G/3D](#) [20021832-06016C1LF](#) [KX15-20KLDL-E1000E](#) [MDF7-16DP-2.54DSA\(55\)](#) [AXE810124](#) [FCN-214J100-G/0](#) [FCN-230C068-E/S](#) [AXE812124](#) [AXE816124](#) [AXE720127](#)