

| LOC | DIST | REVISIONS ÄNDERUNGEN | | | DATE | DWN | APVD |
|---------------------------|------|-------------------------|-----|-----------------------------|------------|-----|------|
| AI | - | P | LTR | DESCRIPTION BESCHREIBUNG | | | |
| PROJEKT NR. EGGMN04410 | B1 | | | DRAWING REWORKED ECR-012713 | 30.05.2007 | GW | BR |

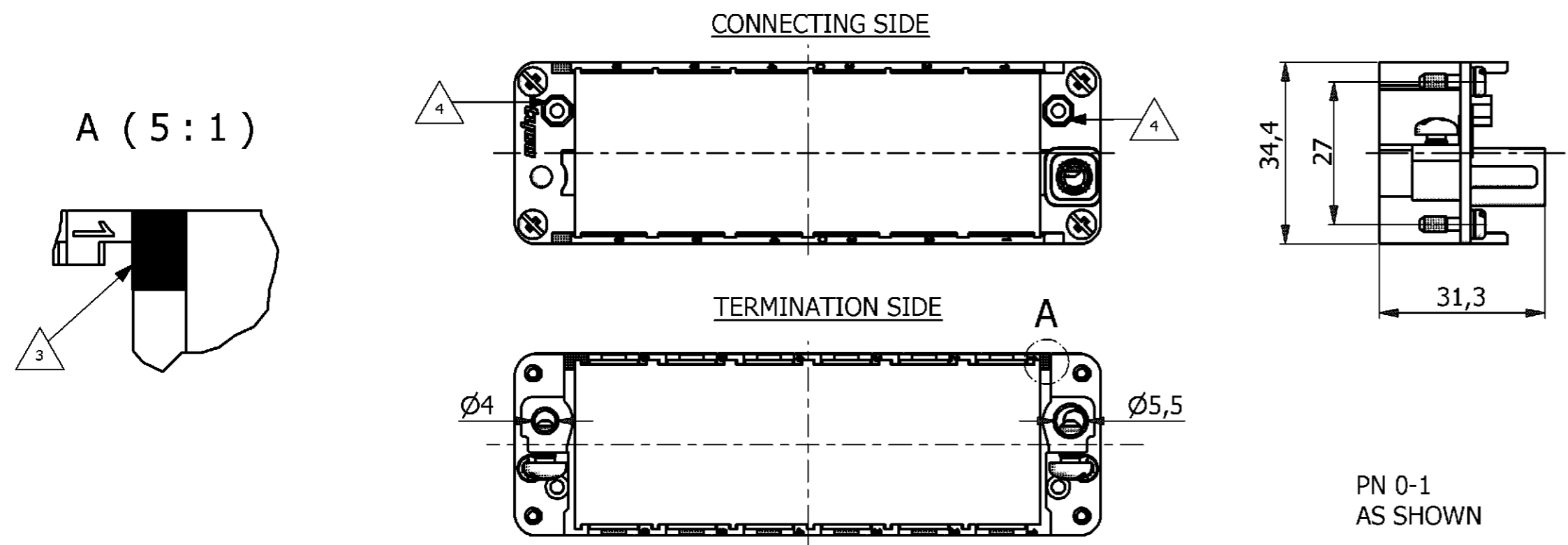

- ### NOTES
- MODUL INSERTS: SERIES HVS SEE CATALOG PN: 889745
 - SUITABLE HOOD SIZE 3 TO 8: SERIES HB; HD; EMV; HF AND HIP CATALOG PN: 889745
 - MARKING OF POLARIZATION ACCORDING TO MARKINGS OF MODULE INSERTS
 - POSITION FOR CODING SET PN: 530341-1
 - PACKAGING: 10 SETS IN A CARTON, PRE MOUNTED

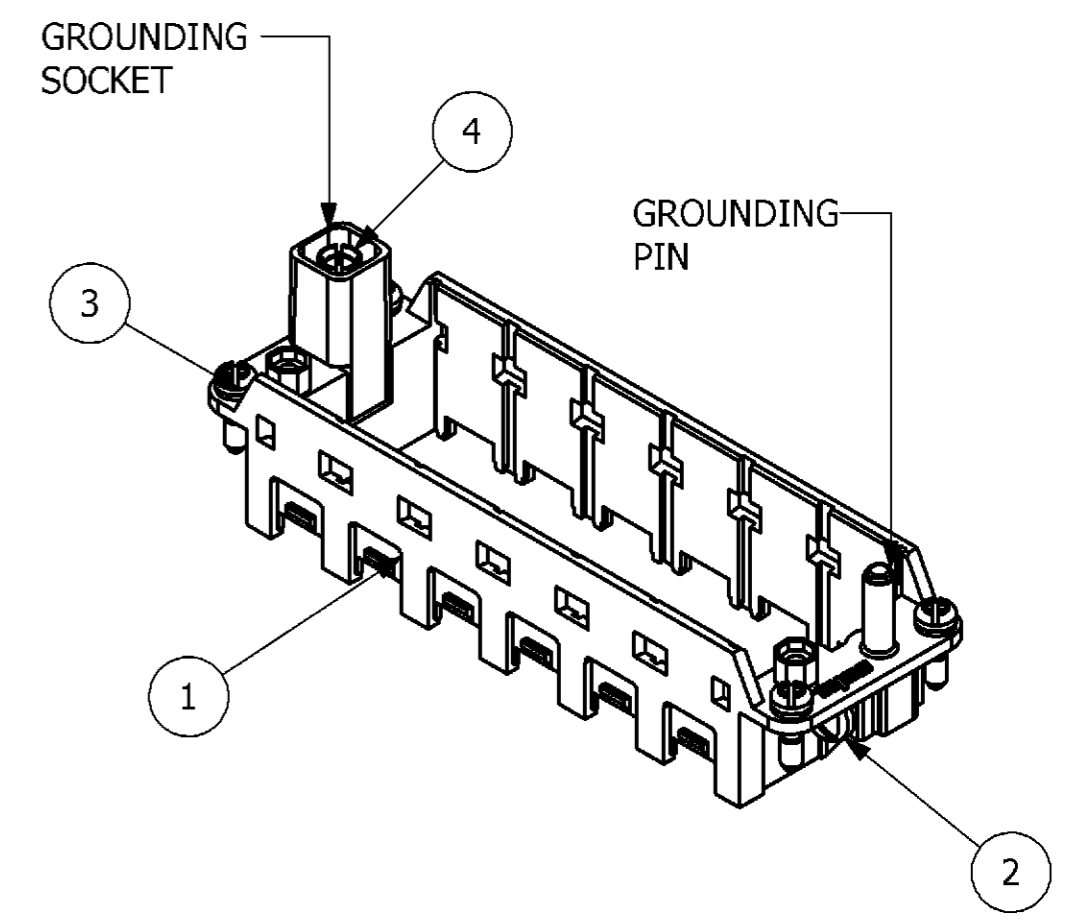
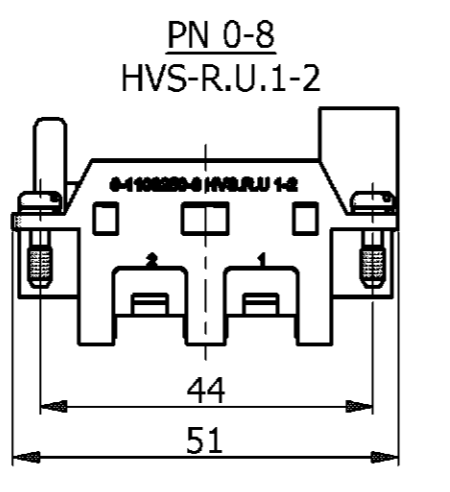
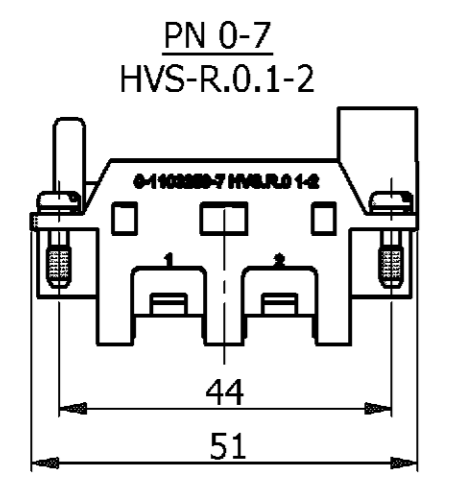
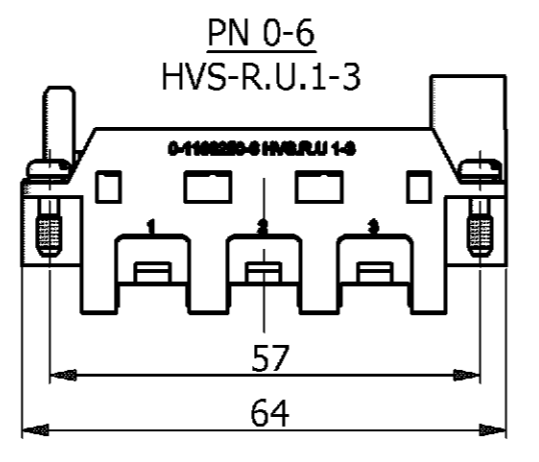
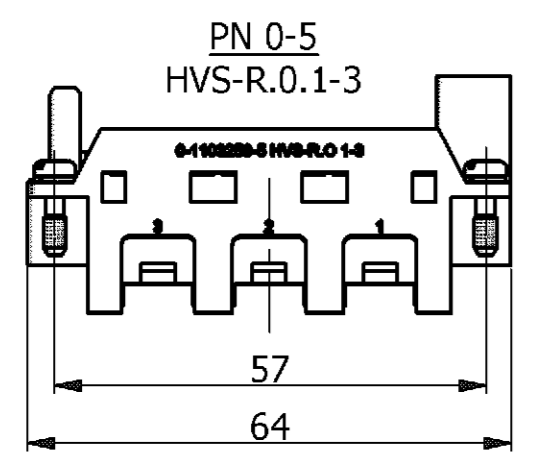
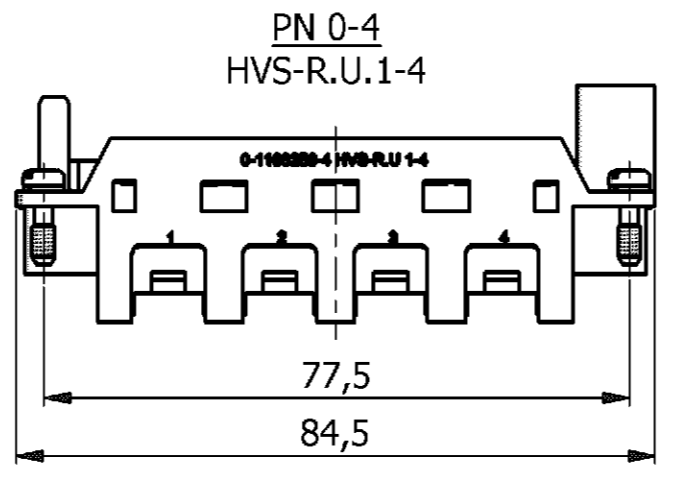
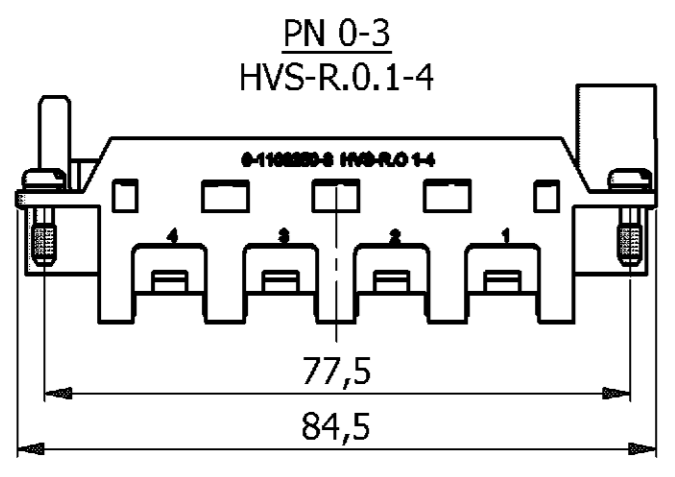
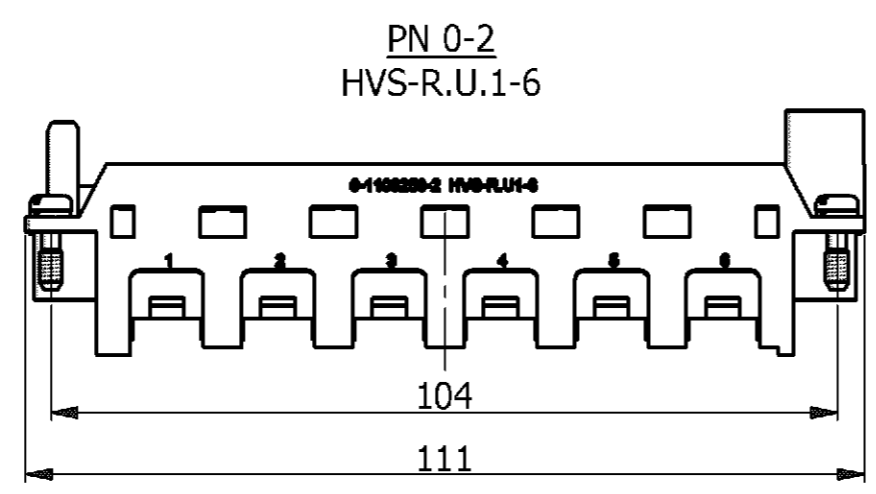
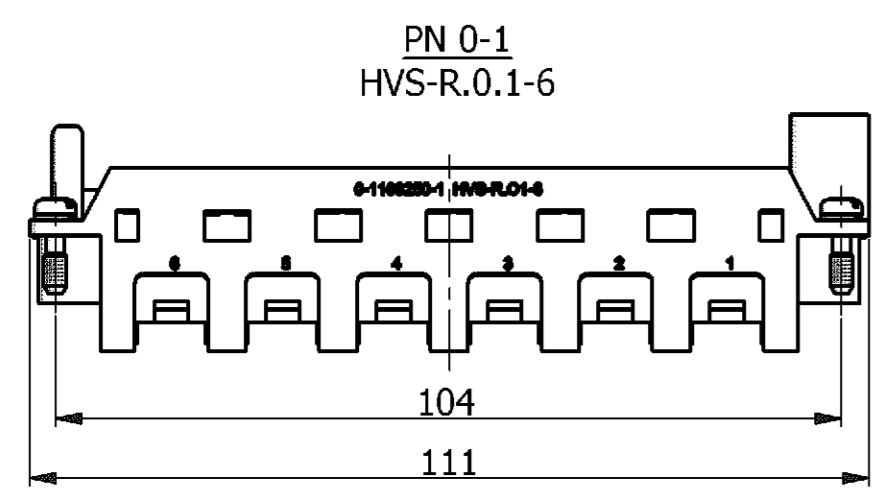

| QTY. | DESCRIPTION | MATERIAL | SURFACE | COLOR | NOTE | ITEM |
|------|----------------|---------------|---------------|-------|------------------------|------|
| 1 | TORSION SPRING | STAINL. STEEL | --- | --- | DIA 6.6X0.5 - 2.5 WDG. | 4 |
| 4 | FIXING SCREW | STEEL | NICKEL PLATED | BLUE | M3X10,5 | 3 |
| 2 | PAN HEAD SCREW | STEEL | NICKEL PLATED | --- | M4*8 | 2 |
| 1 | FRAME | ZINC | NICKEL PLATED | --- | --- | 1 |

THIS DRAWING IS A CONTROLLED DOCUMENT FOR AMP INCORPORATED. IT IS SUBJECT TO CHANGE AND THE CONTROLLING ENGINEERING ORGANIZATION SHOULD BE CONTACTED FOR THE LATEST REVISION. DIESSE ZEICHNUNG WIRD WÄHREND DER HERSTELLUNG VON ERFAHRENDEN ANGEZEIGTEN, DIE DIE TECHNISCHEN FERTIGKEITEN, SIND VORBEREITET, DEN JEWELIGS LETZTGLÜBTIGEN ÄNDERUNGSSTAND ERFAHREN SIE AUF ANFRAGE.

DIMENSIONS: mm

TOLERANCES UNLESS OTHERWISE SPECIFIED: ALLGEMEINTOLERANZEN

0 PLC #
1 PLC #
2 PLC #
3 PLC #
ANGLES / WINKEL #

MATERIAL FINISH / OBERFLÄCHE / FARBE

DWN 16.02.2006
CHK H.BRAUN 17.02.2006
APVD T.SCHNURPFEL 17.02.2006

NAME
T.SCHNURPFEL

PRODUCT SPEC. / PRODUKTSPEZ. 108-74075

APPLICATION SPEC. / VERARBEITUNGSSPEZ. 114-74080

WEIGHT / GEWICHT 0,001 KG

SCALE / MASSSTAB 1:1

SHEET / BLATT 1 OF 1 VON 1

REV. B1

ASSY MODULE FRAME
SERIES HVS, SIZE 1-4

1103250

CUSTOMER DRAWING / KUNDENZEICHNUNG

Tyco / Electronics AMP GmbH
D - 53819 Neunkirchen

X-ON Electronics

Largest Supplier of Electrical and Electronic Components

Click to view similar products for [Heavy Duty Power Connectors](#) category:

Click to view products by [TE Connectivity](#) manufacturer:

Other Similar products are found below :

[1424439](#) [1424438](#) [09330062652](#) [605601-1](#) [6340G1](#) [6341G1](#) [6360G1](#) [6373G1](#) [6374g2](#) [6396G1](#) [647757-1](#) [6643411-1](#) [6646058-2](#) [6646137-1](#)
[6646138-1](#) [6646348-1](#) [6646479-1](#) [6646608-1](#) [6646786-1](#) [6646940-1](#) [6651525-1](#) [6651529-1](#) [6651778-1](#) [6651788-1](#) [696465-1](#) [696475-1](#)
[73000005059](#) [73000005349](#) [73000005642](#) [73080965046](#) [765-15-0080A](#) [765-16-0080B](#) [789.700-44](#) [789.700-54](#) [80-1010](#) [80-9](#) [827381-1](#)
[829992-1](#) [902-77-02113](#) [PL00U-301-10D10](#) [PM103MOOLOO](#) [PM212MOOLOO](#) [PM309FOOLOO](#) [PM324FOOLCH](#) [PMHPAF11S03](#)
[PMHPAF14S01](#) [PMHPAM14P05](#) [PMHPAS06](#) [PMHPBF14S01](#) [PP45PC12S](#)