

LOC	DIST	REVISIONS ÄNDERUNGEN			DATE	DWN	APVD
AI	-	P	LTR	DESCRIPTION BESCHREIBUNG			
PROJEKT NR. EGGMN04410	B1	DRAWING REWORKED ECR-012713			30.05.2007	GW	BR

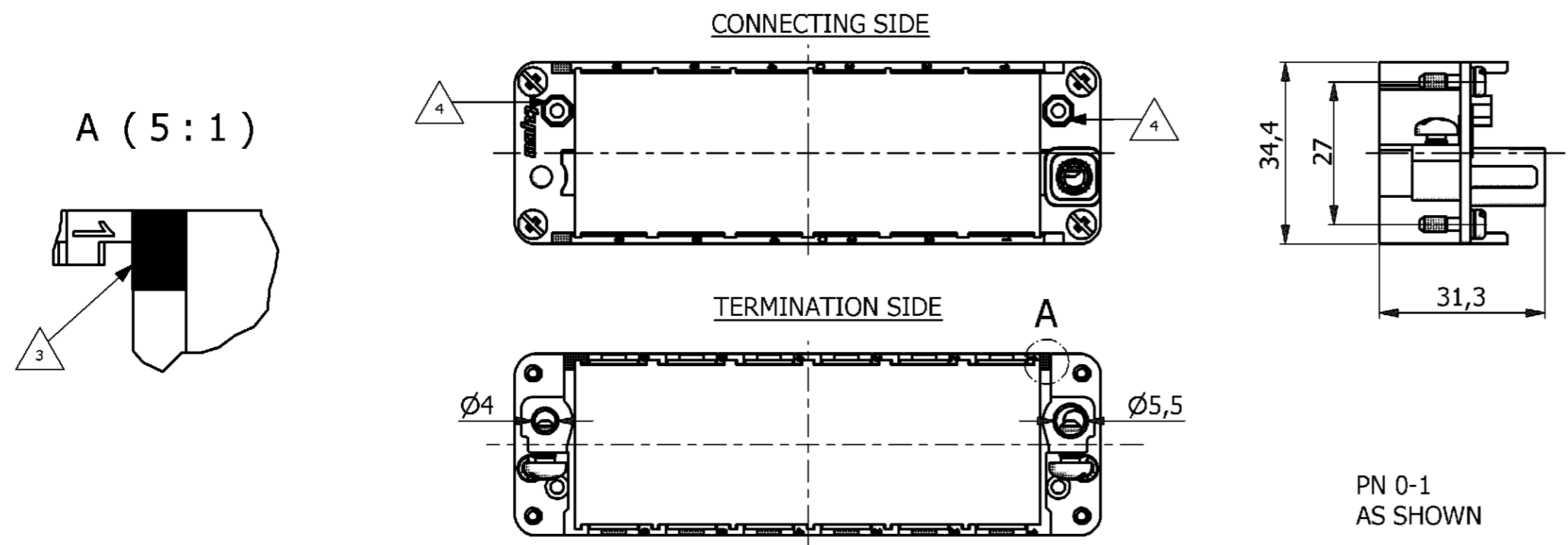

- ### NOTES
- MODUL INSERTS: SERIES HVS SEE CATALOG PN: 889745
  - SUITABLE HOOD SIZE 3 TO 8: SERIES HB; HD; EMV; HF AND HIP CATALOG PN: 889745
  - MARKING OF POLARIZATION ACCORDING TO MARKINGS OF MODULE INSERTS
  - POSITION FOR CODING SET PN: 530341-1
  - PACKAGING: 10 SETS IN A CARTON, PRE MOUNTED

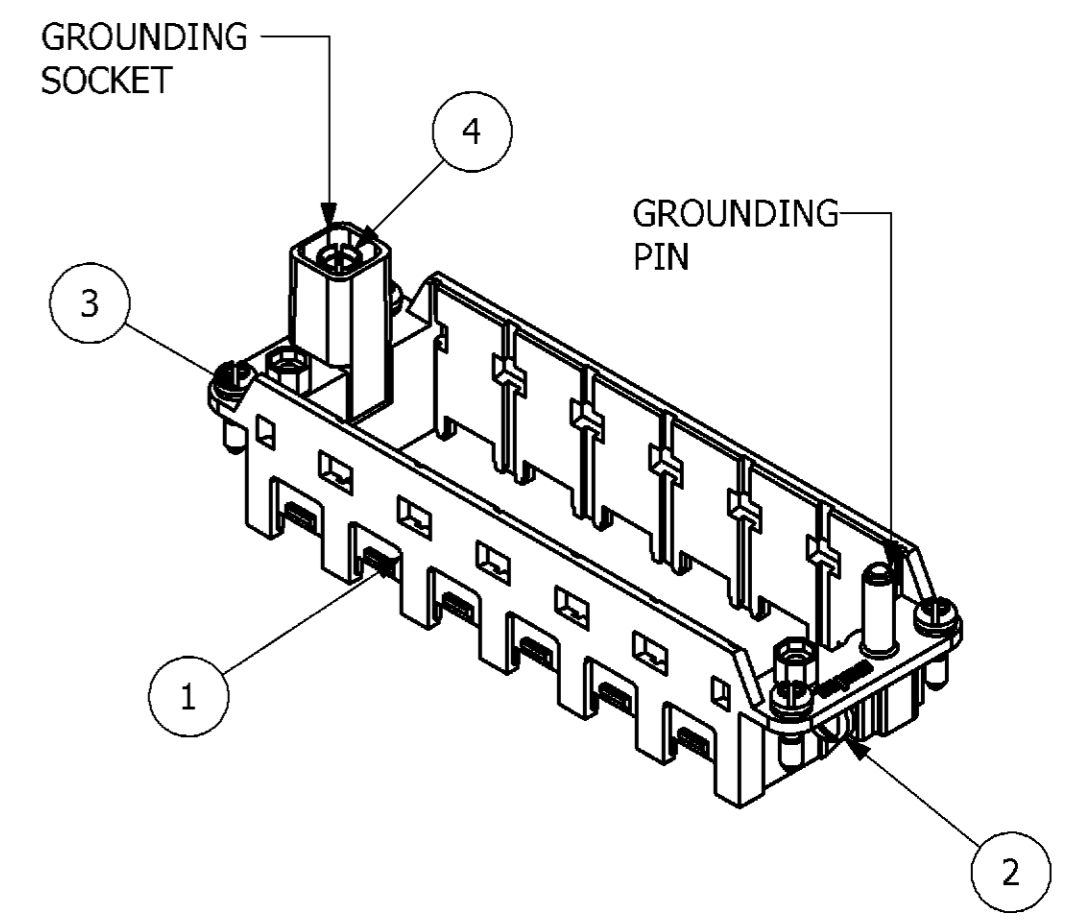
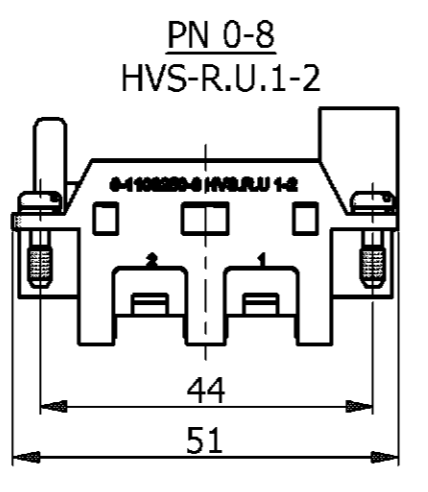
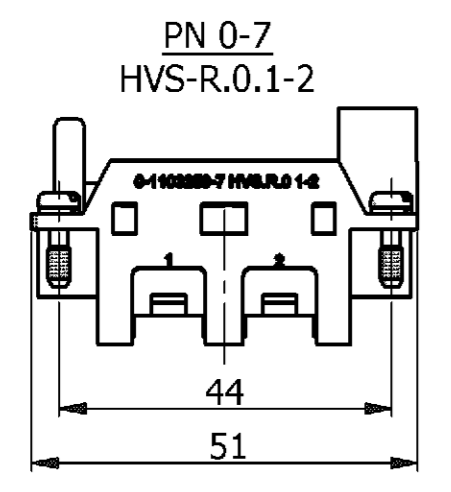
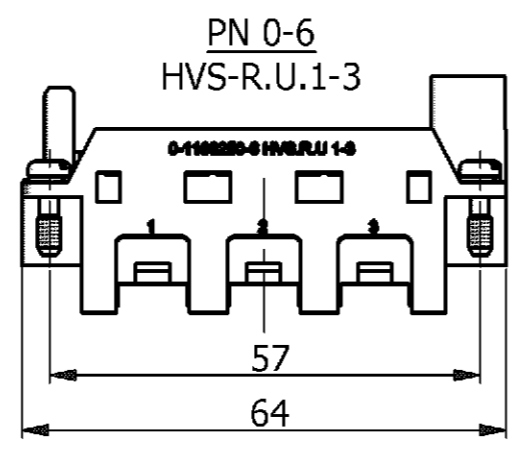
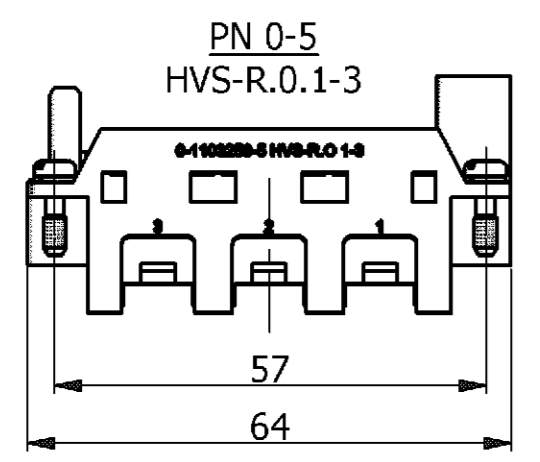
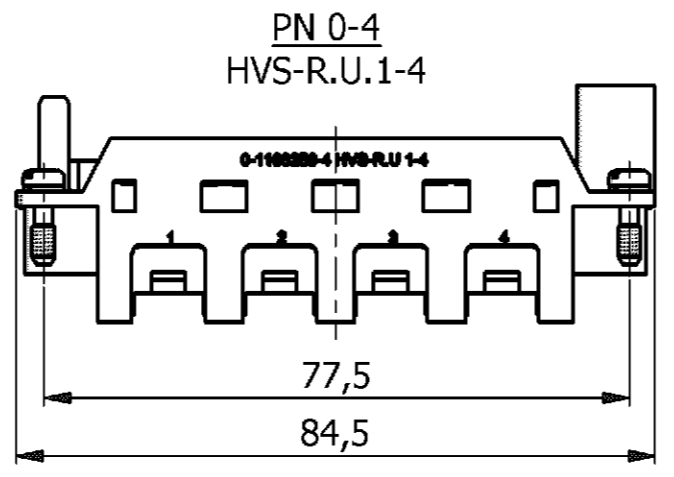
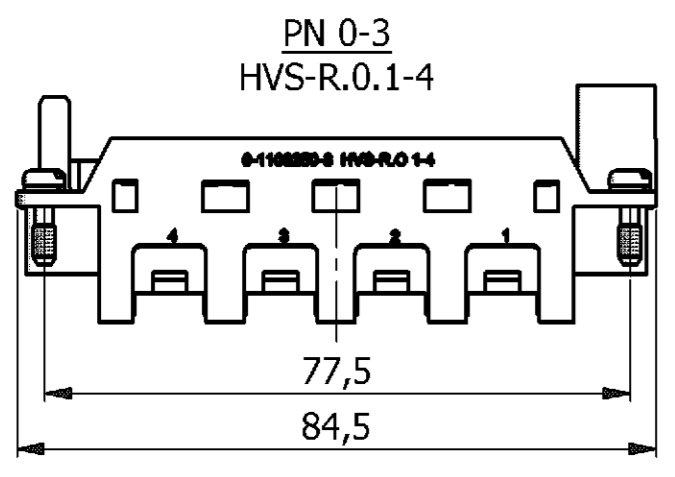
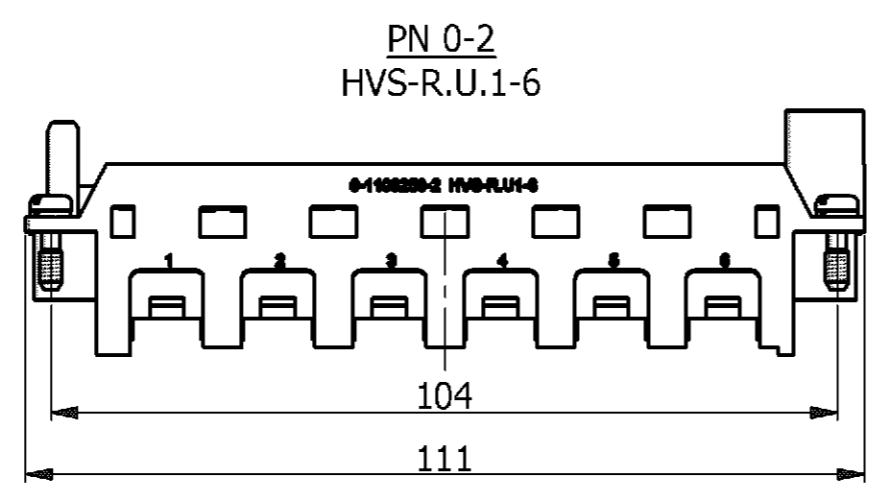
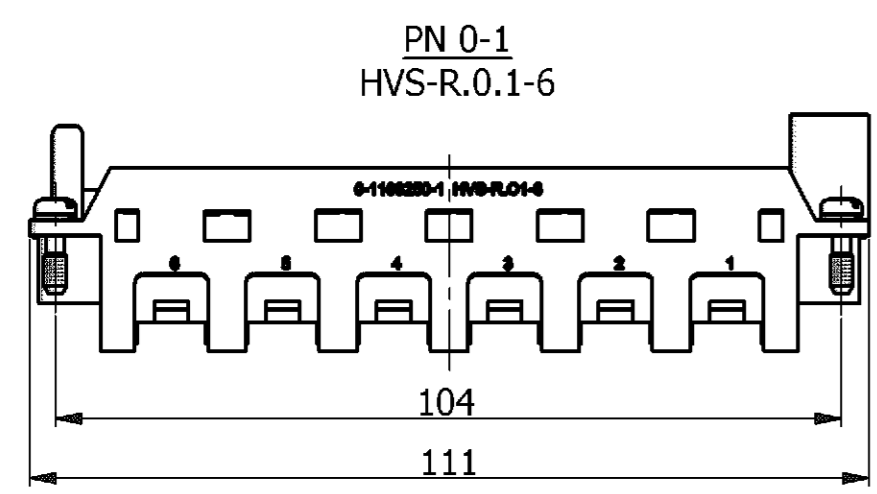

QTY.	DESCRIPTION	MATERIAL	SURFACE	COLOR	NOTE	ITEM
1	TORSION SPRING	STAINL. STEEL	---	---	DIA 6.6X0.5 - 2.5 WDG.	4
4	FIXING SCREW	STEEL	NICKEL PLATED	BLUE	M3X10,5	3
2	PAN HEAD SCREW	STEEL	NICKEL PLATED	---	M4*8	2
1	FRAME	ZINC	NICKEL PLATED	---	---	1

THIS DRAWING IS A CONTROLLED DOCUMENT FOR AMP INCORPORATED. IT IS SUBJECT TO CHANGE AND THE CONTROLLING ENGINEERING ORGANIZATION SHOULD BE CONTACTED FOR THE LATEST REVISION. DIESSE ZEICHNUNG WIRD WÄHREND DER HERSTELLUNG VON VERBUNDENEN ANDERUNGEN, DIE DIE TECHNISCHEN EIGENSCHAFTEN BEEINTRÄCHTIGEN, JEDWELCHE LETZTLIEGENDE ANDERUNGSSTAND BEFOLGEN SIE AUF ANFRAGE.

TOLERANCES UNLESS OTHERWISE SPECIFIED:  
ALLGEMEINTOLERANZEN:  
n. ISO 8015 - mmH-E  
n. ISO 2768 - #  
n. DIN 16901- #  
ANGLES / WINKEL #

DIMENSIONS: mm

MATERIAL

FINISH / OBERFLÄCHE / FARBE

WEIGHT / GEWICHT

DWN 16.02.2006  
CHK H.BRAUN 17.02.2006  
APVD T.SCHNURPFEL 17.02.2006

NAME  
T.SCHNURPFEL

PRODUCT SPEC. / PRODUKTSPEZ. 108-74075

APPLICATION SPEC. / VERARBEITUNGSSPEZ. 114-74080

WEIGHT / GEWICHT 0,001 KG

SCALE / MASSSTAB 1:1

SHEET / BLATT 1 OF 1 VON 1

REV. B1

ASSY MODULE FRAME  
SERIES HVS, SIZE 1-4

1103250

CUSTOMER DRAWING / KUNDENZEICHNUNG

Tyco / Electronics AMP GmbH  
D - 53819 Neunkirchen

## X-ON Electronics

Largest Supplier of Electrical and Electronic Components

*Click to view similar products for [TE Connectivity](#) manufacturer:*

Other Similar products are found below :

[D38999/24FJ4AN](#) [570416-000](#) [CLTEQ-M81CE-SSRELAY-4-20V](#) [4-1195131-0](#) [650069-000](#) [SMD100-2](#) [358838-000](#) [CB-1022B-78](#)  
[RM707012](#) [RP410012](#) [MMS42](#) [1-640426-8](#) [2EDL4CM](#) [DTS20W19-11PD-3028-LC](#) [RM202615](#) [NC6-P104-06](#) [MSPS103B](#) [DTS26F21-](#)  
[41HE-LC](#) [DTS26F21-41AE](#) [DTS26F21-41PE-LC](#) [DTS26F21-11SE-3028-LC](#) [30DCB6](#) [1932144-1](#) [293545-4](#) [LVR125S](#) [MS27466T25F4PB](#)  
[CKB-38-78010](#) [TR04AI-TINELLOCKRING](#) [1206SFF150F/63-2](#) [D38999/20JB35HA](#) [TE1500A2R2J](#) [D38999/20WC8BB](#) [DTS24F19-11SC-](#)  
[3028-LC](#) [D38999/24WG11HA](#) [D38999/24WG11HN](#) [MS27467T21F11H](#) [DJT16E21-11HA](#) [MS27467T21F35J](#) [MS27467T21F11J](#)  
[MS27467T21F16H-LC](#) [MS27467T21F35H](#) [MS27467T21F41H-LC](#) [1206SFH150F/24-2](#) [RP330024](#) [DJT16E21-11PA-LC](#) [DJT16E21-11HA-](#)  
[LC](#) [DJT16E21-11AA](#) [MS27467T21B11JA](#) [DJT16E21-11JA](#) [MS27467T21B11JA-LC](#)