

LOC
A1

DIST

REVISIONS

P	LTR	DESCRIPTION	DATE	DWN	APVD
	C	ECR-15-007608	30MAY2015	GSK	JB

PN 0-1 As Shown

Contact arrangement
view from connecting side

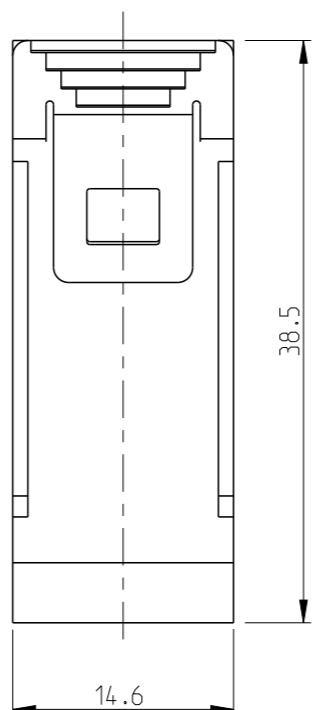
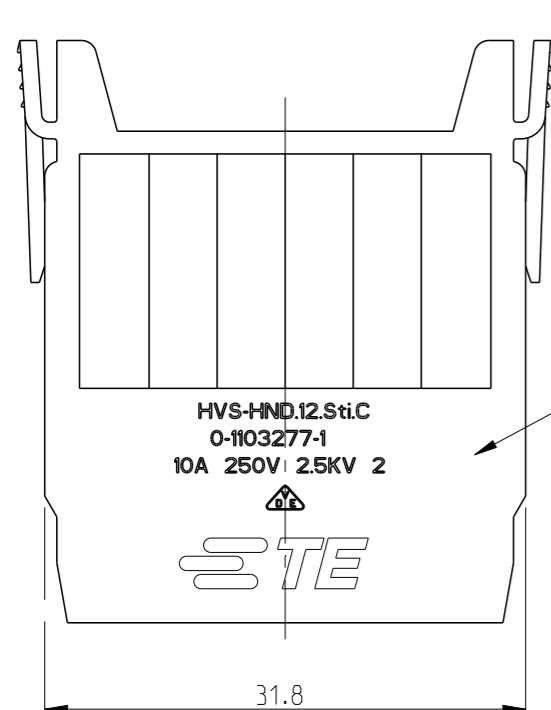
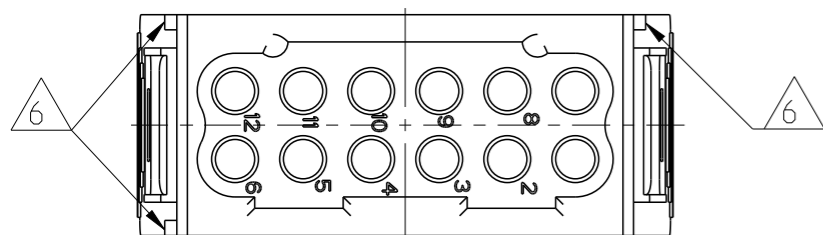

Contact arrangement
view from termination side

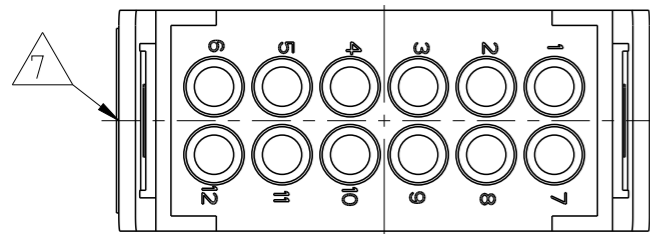

NOTES

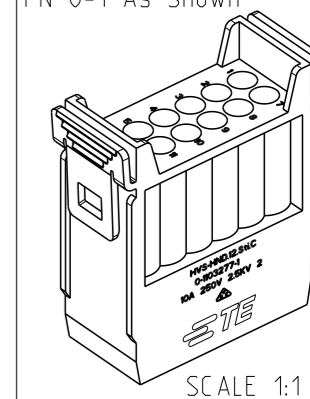

- 1 SUITABLE CRIMP CONTACTS: SERIES HN.D
CUSTOMER DRAWING: 1105051
OUTER DIMENSIONS OF INSULATION: MAX. Ø4mm
- 2 SUITABLE MODULE FIXING FRAME: SERIES HVS SIZE 3 TO 8
CUSTOMER DRAWING: 1103250
- 3 SUITABLE INSERTION TOOL:
CUSTOMER DRAWING: 1102855
- 4 SUITABLE EXTRACTION TOOL:
CUSTOMER DRAWING: 1102855
- 5 STANDARDS:
DIN EN 61984; DIN EN 60664-1
- 6 POLARIZATION RIPS
- 7 MARKING OF POLARIZATION ACCORDING TO MARKING OF
MODULE FRAME
- 8 PACKAGING:
10 PIECES IN A CARTON

PN 0-1 As Shown

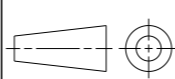

SCALE 1:1

QTY	DESCRIPTION	MATERIAL	COLOR	ITEM NO
1	MALE INSERT	PBT-GF10	LIGHT GREY	1
PN 0-1 / HVS-HND.12.Sti.C				

THIS DRAWING IS A CONTROLLED DOCUMENT.		DWN SCHNEIDER 20.02.2006	 TE Connectivity	
DIMENSIONS: mm		CHK A.GAST 20.02.2006		
		APVD T.SCHNURPFIL 20.02.2006	NAME MALE INSERT HVS-HND.12.STI.C	
TOLERANCES UNLESS OTHERWISE SPECIFIED: ISO 8075 DIN ISO 2768 mH-E DIN 16901-120		PRODUCT SPEC 108-74083	RESTRICTED TO	
0 PLC ± 1 PLC ± 2 PLC ± 3 PLC ± 4 PLC ± ANGLES ±		APPLICATION SPEC 114-74085	SIZE A3	CAGE CODE 00779
MATERIAL		WEIGHT	DRAWING NO C=1103277	
FINISH		CUSTOMER DRAWING		SCALE 2:1
				SHEET 1 OF 1
				REV C

X-ON Electronics

Largest Supplier of Electrical and Electronic Components

Click to view similar products for [Heavy Duty Power Connectors](#) category:

Click to view products by [TE Connectivity](#) manufacturer:

Other Similar products are found below :

[647757-1](#) [6643411-1](#) [6646058-2](#) [6646137-1](#) [6646138-1](#) [6646479-1](#) [6646608-1](#) [6646786-1](#) [6646940-1](#) [6651091-1](#) [6651525-1](#) [6651529-1](#)
[6651788-1](#) [696475-1](#) [702-32-01109](#) [703-25-02205](#) [73000005059](#) [73000005642](#) [73080255059](#) [73080965046](#) [765-15-0080A](#) [765-16-0080B](#)
[765-18-0080D](#) [829992-1](#) [902-77-02113](#) [PS00/A0620/6300](#) [PS25/A0420/63](#) [129-1J](#) [1409400](#) [AN0024023](#) [E6374G1](#) [e6389g2](#) [157-43GW8](#)
[MS3117-14AC](#) [1643543-1](#) [1650540-1](#) [1651811-2](#) [1766260-1](#) [1766282-1](#) [1766966-1](#) [1791340000](#) [NLDFT-3-BL-L-S120-M40A](#) [NLDFT-N-](#)
[W-L-C240-M40B](#) [NLS-2-R-C240-M40B](#) [NLS-N-W-C240-M40B](#) [NPS-3-BL-T6](#) [1986615-1](#) [2-1589900-8](#) [2199314-1](#) [KA8102](#)