

THIS DRAWING IS UNPUBLISHED. RELEASED FOR PUBLICATION
 © COPYRIGHT - By - ALL RIGHTS RESERVED.

LOC	DIST	REVISIONS			
P	LTR	DESCRIPTION	DATE	DWN	APVD
AD	00	G2	REVISED PER ECO-12-013195	18JUL12	KH MM

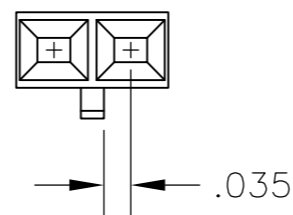

DETAIL FOR -1 ONLY
(2 POSITION)

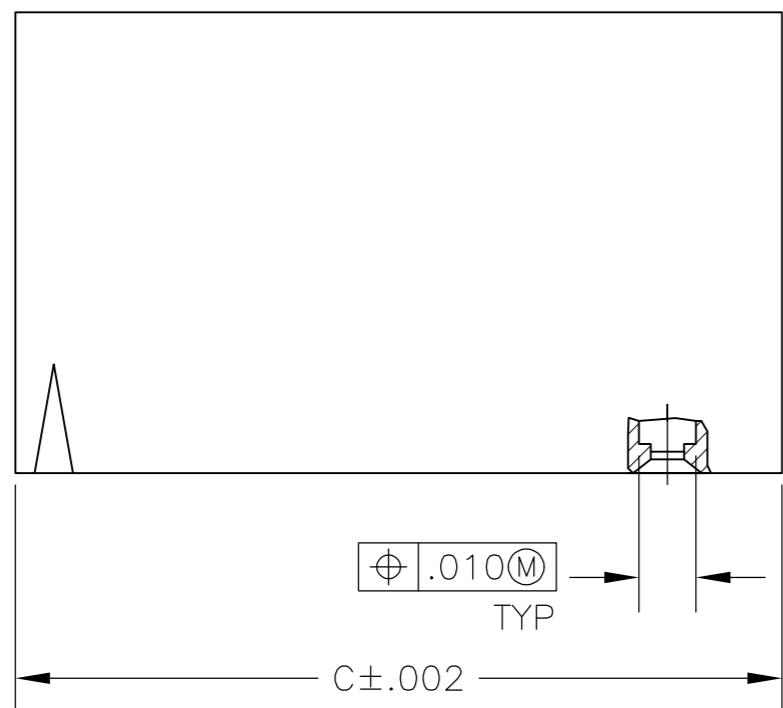
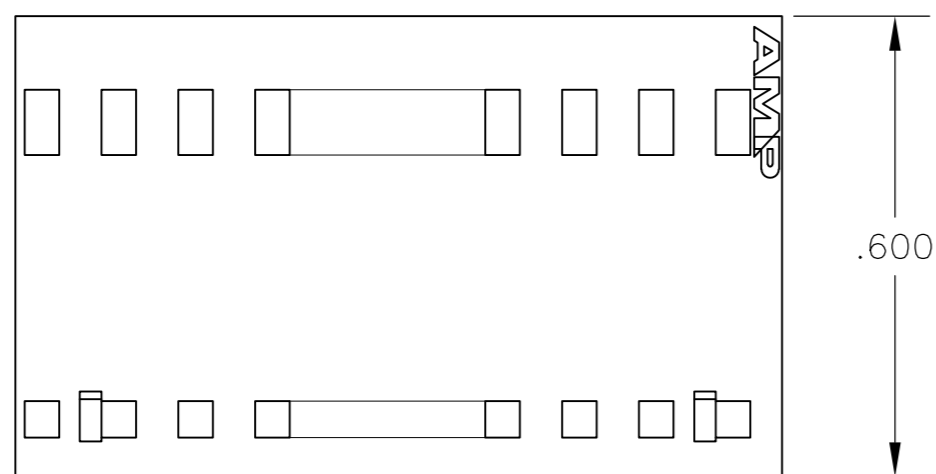
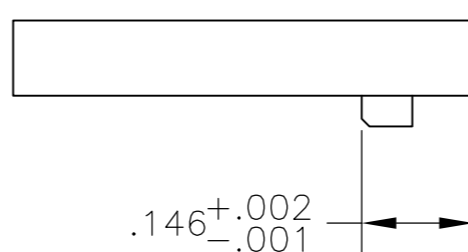
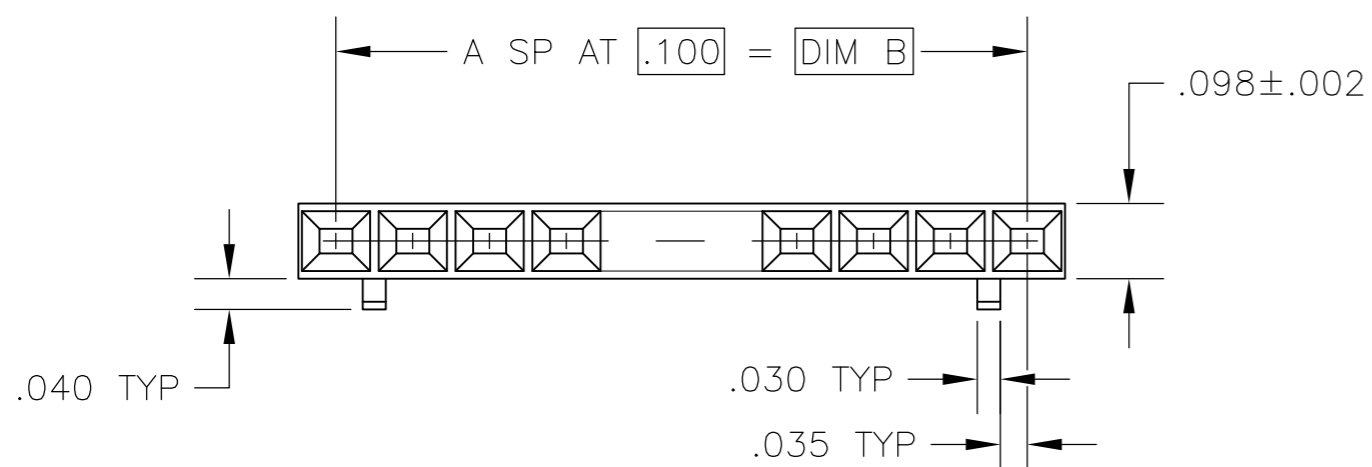

2.498	2.400	24	25	2-104503-4
2.398	2.300	23	24	2-104503-3
1.998	1.900	19	20	1-104503-9
1.598	1.500	15	16	1-104503-5
1.498	1.400	14	15	1-104503-4
1.398	1.300	13	14	1-104503-3
1.298	1.200	12	13	1-104503-2
1.198	1.100	11	12	1-104503-1
1.098	1.000	10	11	1-104503-0
.998	.900	9	10	104503-9
.898	.800	8	9	104503-8
.798	.700	7	8	104503-7
.698	.600	6	7	104503-6
.598	.500	5	6	104503-5
.498	.400	4	5	104503-4
.398	.300	3	4	104503-3
.298	.200	2	3	104503-2
.198	.100	1	2	104503-1
C	B	A	NO OF POSN	PART NUMBER

THIS DRAWING IS A CONTROLLED DOCUMENT.		DWN D KEITZER 12-21-88																				
DIMENSIONS: INCHES		CHK H. MOLL 12-22-88																				
TOLERANCES UNLESS OTHERWISE SPECIFIED:		APVD C. SINISI 12-22-88	NAME																			
<table border="1"> <tr><td>0 PLC</td><td>±</td><td>-</td></tr> <tr><td>1 PLC</td><td>±</td><td>-</td></tr> <tr><td>2 PLC</td><td>±</td><td>-</td></tr> <tr><td>3 PLC</td><td>±</td><td>.005</td></tr> <tr><td>4 PLC</td><td>±</td><td>-</td></tr> <tr><td>ANGLES</td><td>±</td><td>-</td></tr> </table>		0 PLC	±	-	1 PLC	±	-	2 PLC	±	-	3 PLC	±	.005	4 PLC	±	-	ANGLES	±	-	PRODUCT SPEC 108-25034	PIN HOUSING, AMPMODU® MTE, SINGLE ROW, .100 C/L, WITH GUIDE RIBS	
0 PLC	±	-																				
1 PLC	±	-																				
2 PLC	±	-																				
3 PLC	±	.005																				
4 PLC	±	-																				
ANGLES	±	-																				
MATERIAL FLAME RETARDANT THERMOPLASTIC, COLOR: BLACK		FINISH -	APPLICATION SPEC 114-25026	RESTRICTED TO																		
		WEIGHT -	SIZE A2	CAGE CODE 00779																		
		CUSTOMER DRAWING	DRAWING NO C=104503	SCALE 4:1																		
			SHEET 1 of 1	REV G2																		

X-ON Electronics

Largest Supplier of Electrical and Electronic Components

Click to view similar products for [Headers & Wire Housings](#) category:

Click to view products by [TE Connectivity](#) manufacturer:

Other Similar products are found below :

[892-18-020-10-001101](#) [58102-G61-06LF](#) [582553-1](#) [0009485154](#) [009176003701906](#) [0050291907](#) [LY20-4P-DT1-P1E-BR](#) [02.125.8002.8](#)
[609-3404](#) [61062-3](#) [61082-181009](#) [622-3653LF](#) [63453-116](#) [636-1030](#) [636-1427](#) [636-3427](#) [636-4007](#) [641938-9](#) [641991-4](#) [644827-2](#) [65817-010LF](#) [65817-015LF](#) [65863-015LF](#) [66207-023LF](#) [67095-007LF](#) [67601157](#) [68645-018](#) [68648-049](#) [70.362.1628.0](#) [70-4210](#) [70-4226B](#) [70-4853B](#) [707-5020](#) [707-5028](#) [71.350.2428.0](#) [71918-208LF](#) [71961-016LF](#) [733-134](#) [733-162](#) [754199-000](#) [760-3052](#) [787-8014-00](#) [79531-3000](#)
[FCN-360C032-B](#) [FCN-367T-T012/H](#) [FCN-723D010/2](#) [80.063.4001.1](#) [800-90-001-10-001000](#) [800-90-010-10-002000](#) [801-43-002-10-013000](#)