

| REVISIONS | | | | | |
|-----------|-----|---------------------------|---------|-----|------|
| P | LTR | DESCRIPTION | DATE | DWN | APVD |
| E5 | | REVISED PER ECR-17-014011 | 27MAR18 | NG | MKO |

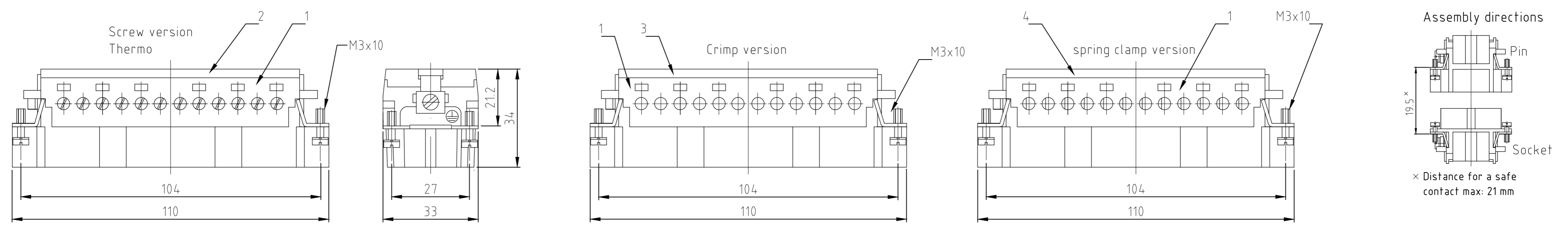

Contact arrangement view from termination side

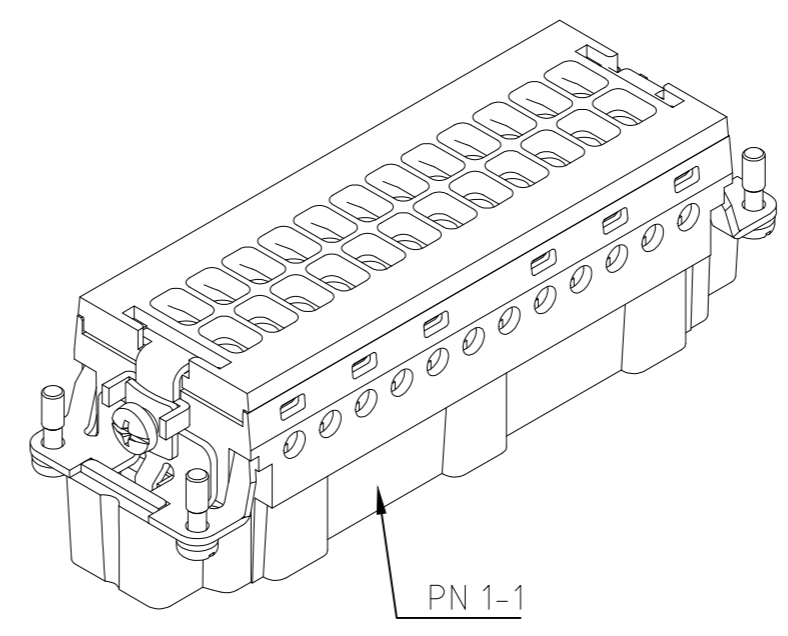
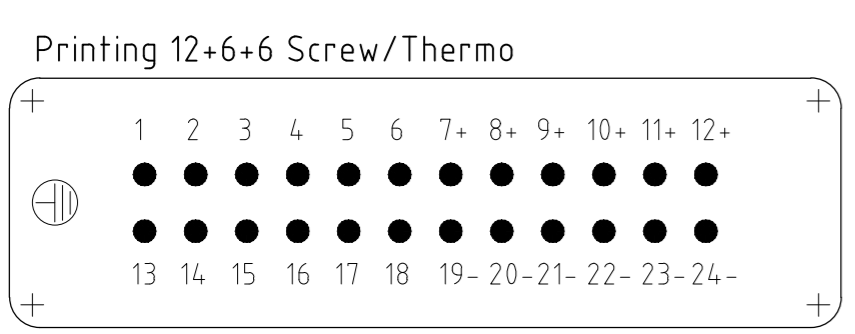
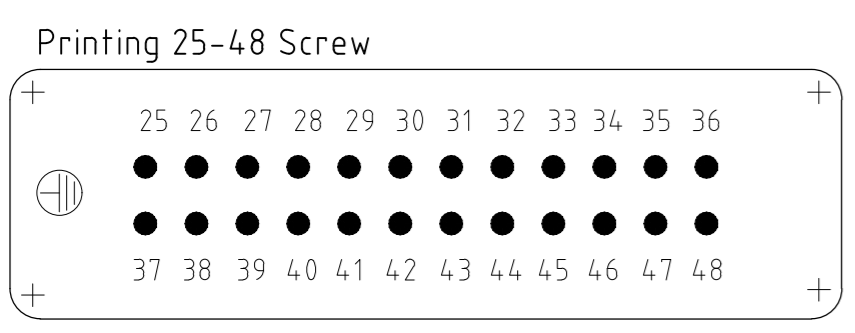
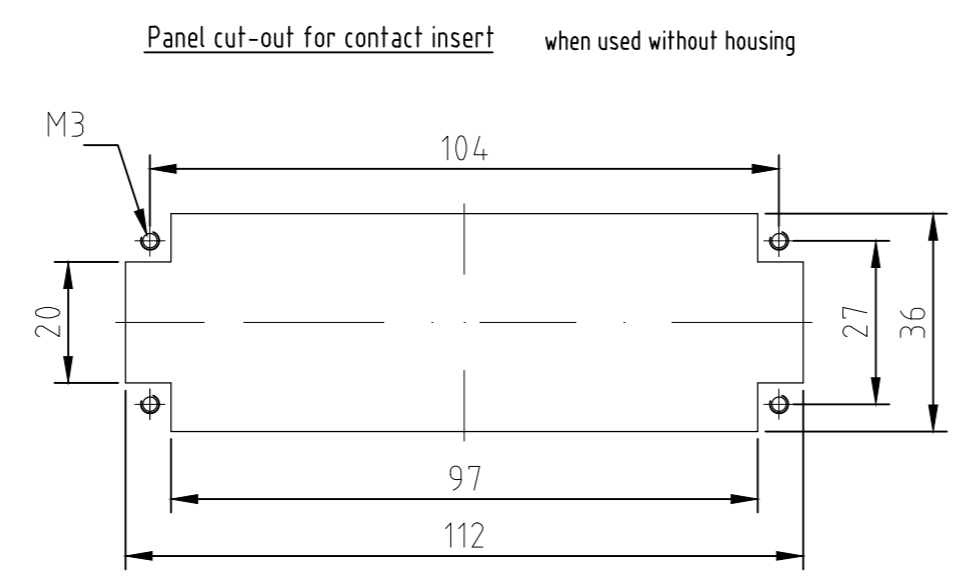
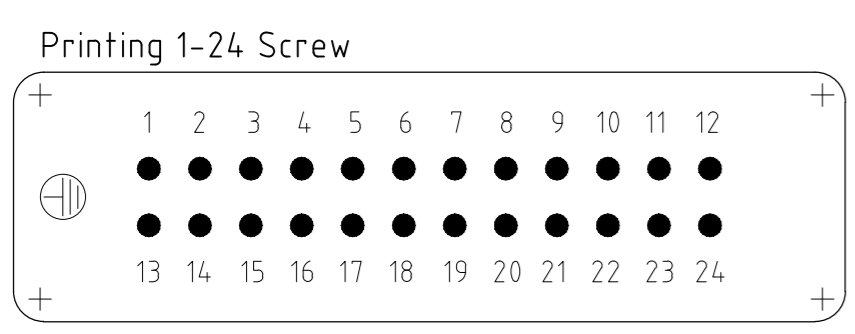
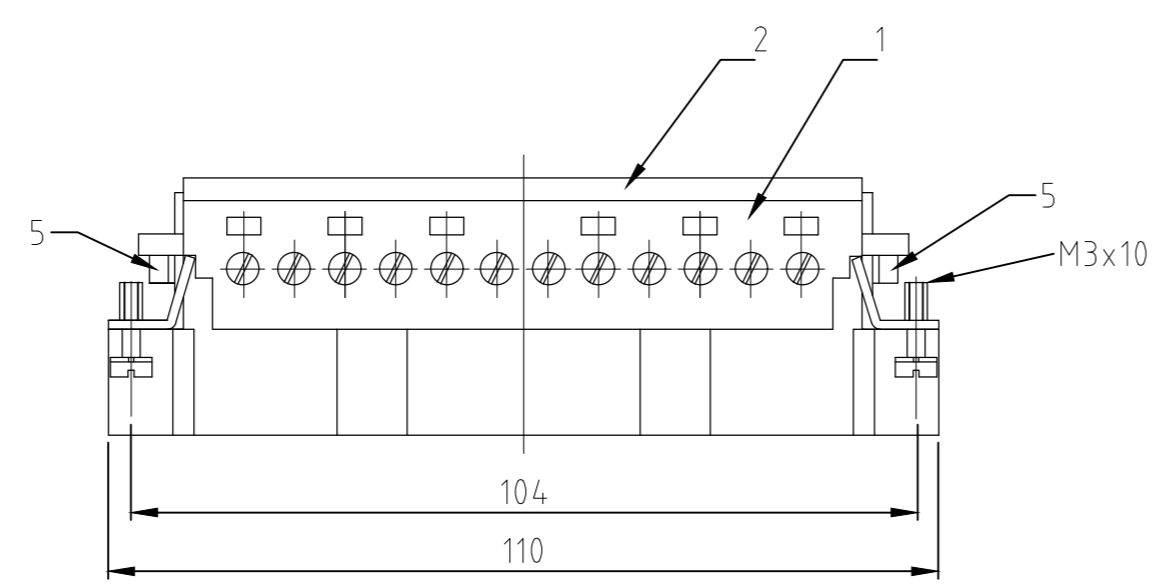
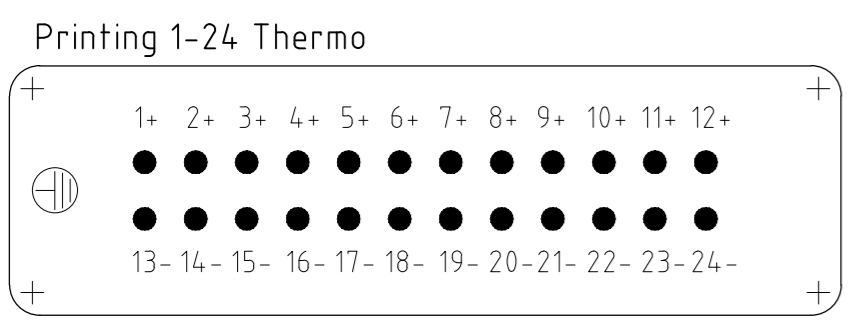

- NOTES:
- SUITABLE CRIMP CONTACTS: SERIES HE/HA
 OUTER DIMENSIONS OF INSULATION: MAX. Ø3,2 MM
 - SUITABLE HOOD SIZE 8; 12: SERIES HB; HD; HIP; EMV
 SUITABLE INSERTION AND EXTRACTION TOOL:
 SCREWDRIVER 0,5x3 DIN 5264
 - Strip length: Screw connection 10mm
 Spring clamp connection 10mm Crimp connection 7.5mm
 - STANDARDS:
 DIN EN 61984; DIN EN 60664-1
 - PACKAGING:
 5 SETS IN A CARTON, PRE-MOUNTED
 - SPECIAL PACKAGING: Krauss-Maffei
 PACKAGING UNIT: 220 PIECES

| ITEM NO. POS. | DESCRIPTION | MATERIAL | COLOR / FARBE | ITEM NO. POS. | NOTES |
|---------------|----------------------------|----------|---------------|---------------|-------|
| 2 | cover spring clamp version | steel | blue | 5 | M4x6 |
| 1 | cover crimp version | | light grey | 4 | |
| 1 | cover screw version | | light grey | 3 | |
| 1 | pin insert | | light grey | 2 | |
| 1 | pin insert | | light grey | 1 | |

| ITEM NO. POS. | DESCRIPTION | MATERIAL | COLOR / FARBE | ITEM NO. POS. | NOTES |
|---------------|--|----------|---------------|---------------|-------|
| 1 | THIS DRAWING IS A CONTROLLED DOCUMENT. | | | | |
| 1 | 0 PLC | | | | |
| 1 | 1 PLC | | | | |
| 1 | 2 PLC | | | | |
| 1 | 3 PLC | | | | |
| 1 | 4 PLC | | | | |
| 1 | ANGLES | | | | |
| 1 | FINISH | | | | |

| ITEM NO. POS. | DESCRIPTION | MATERIAL | COLOR / FARBE | ITEM NO. POS. | NOTES |
|---------------|------------------------------|----------|---------------|---------------|-------|
| 1 | Male insert HE.24.STI.S/C | | | | |

| SIZE | CAGE CODE | DRAWING NO. | RESTRICTED TO |
|------|-----------|-------------|---------------|
| A2 | 00779 | C=1103640 | - |

| CUSTOMER DRAWING | SCALE | SHEET | OF | REV |
|------------------|-------|-------|----|-----|
| | 1:1 | 1 | 1 | E5 |

X-ON Electronics

Largest Supplier of Electrical and Electronic Components

Click to view similar products for [Heavy Duty Power Connectors](#) category:

Click to view products by [TE Connectivity](#) manufacturer:

Other Similar products are found below :

[647757-1](#) [6643411-1](#) [6646058-2](#) [6646137-1](#) [6646138-1](#) [6646479-1](#) [6646608-1](#) [6646786-1](#) [6646940-1](#) [6651091-1](#) [6651525-1](#) [6651529-1](#)
[6651788-1](#) [696475-1](#) [702-32-01109](#) [703-25-02205](#) [73000005059](#) [73000005642](#) [73080255059](#) [73080965046](#) [765-15-0080A](#) [765-16-0080B](#)
[765-18-0080D](#) [829992-1](#) [902-77-02113](#) [PS00/A0620/6300](#) [PS25/A0420/63](#) [129-1J](#) [1409400](#) [AN0024023](#) [E6374G1](#) [e6389g2](#) [157-43GW8](#)
[MS3117-14AC](#) [1643543-1](#) [1650540-1](#) [1651811-2](#) [1766260-1](#) [1766282-1](#) [1766966-1](#) [1791340000](#) [NLDFT-3-BL-L-S120-M40A](#) [NLDFT-N-](#)
[W-L-C240-M40B](#) [NLS-2-R-C240-M40B](#) [NLS-N-W-C240-M40B](#) [NPS-3-BL-T6](#) [1986615-1](#) [2-1589900-8](#) [2199314-1](#) [KA8102](#)