

LOC		DIST		REVISIONS			
GP	00	REV	DESCRIPTION	DATE	BY	CHK	APP
		N2	REVISED PER ECO-06-020813	25/OCT/06	ZR	CR	
		N3	REV PER ECO-09-020932	01SEP09	KK	AEG	

- △ HOUSING MATERIAL: UL RATED 94V-0 LCP THERMOPLASTIC, COLOR-BLACK.
- COVER MATERIAL: UL RATED 94V-0 POLYESTER MOLDING COMPOUND, COLOR-BLACK.
- △ CONTACT MATERIAL: COPPER ALLOY.
- △ CONTACT FINISH: 0.00254-0.00508 [.00100-.000200] BRIGHT TIN-LEAD OVER 0.00127-0.00254 [.000050-.000100] NICKEL.
- △ POSITION 1 INDICATOR; OMITTED FOR PART NUMBER 2-111595-1.
- △ OBSOLETE.
- △ VOID CORES MAY OR MAY NOT BE PRESENT BETWEEN ANY 2 ROWS OF CONTACTS.
- △ OBSOLETE PARTS: OBSOLETE CIS STREAMLINING PER D.RENAUD/D.SINISI

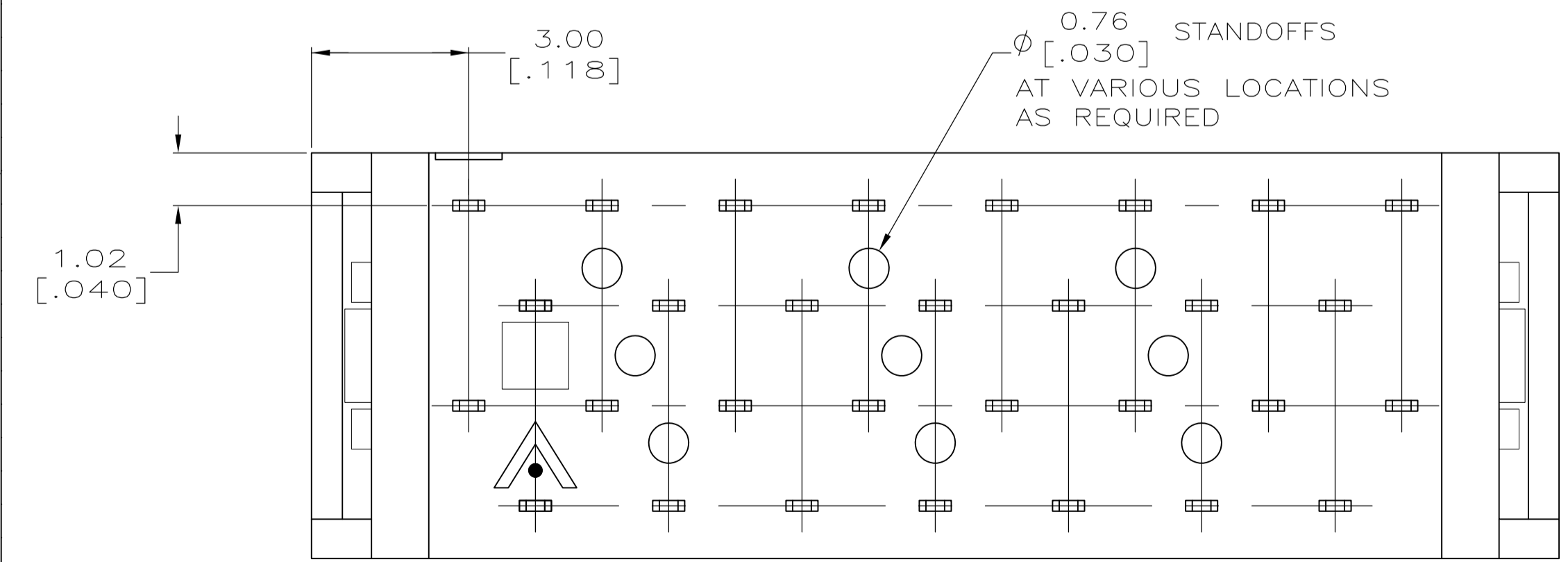
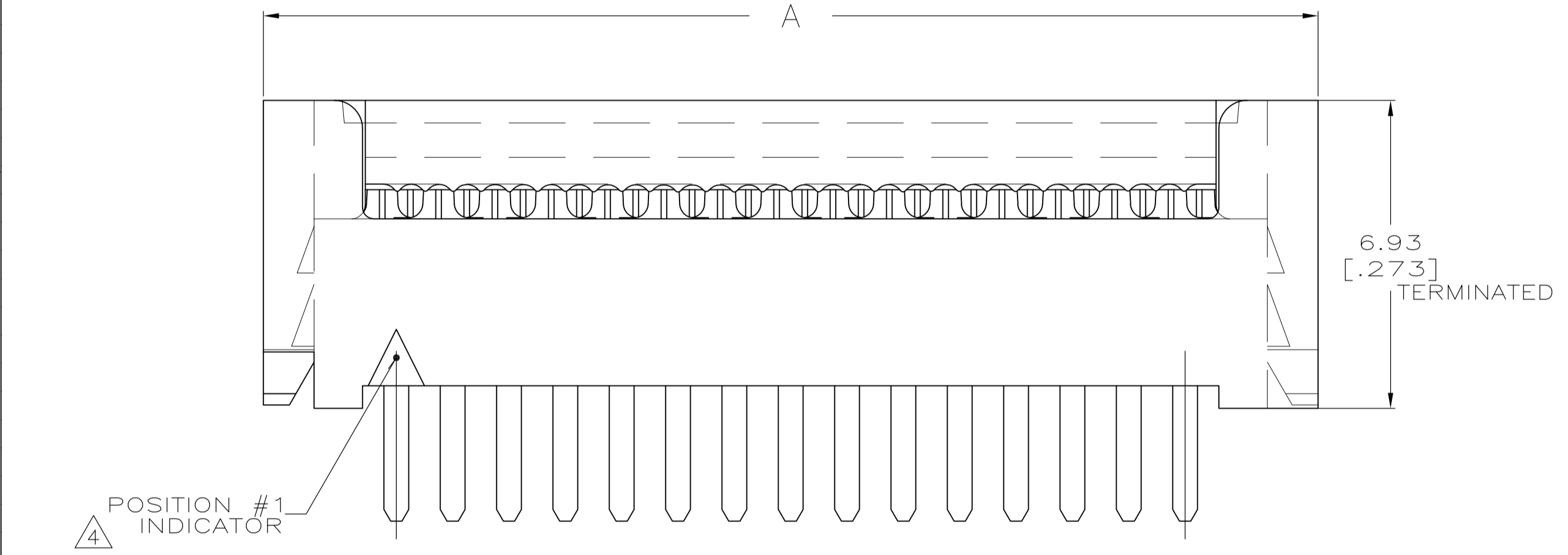
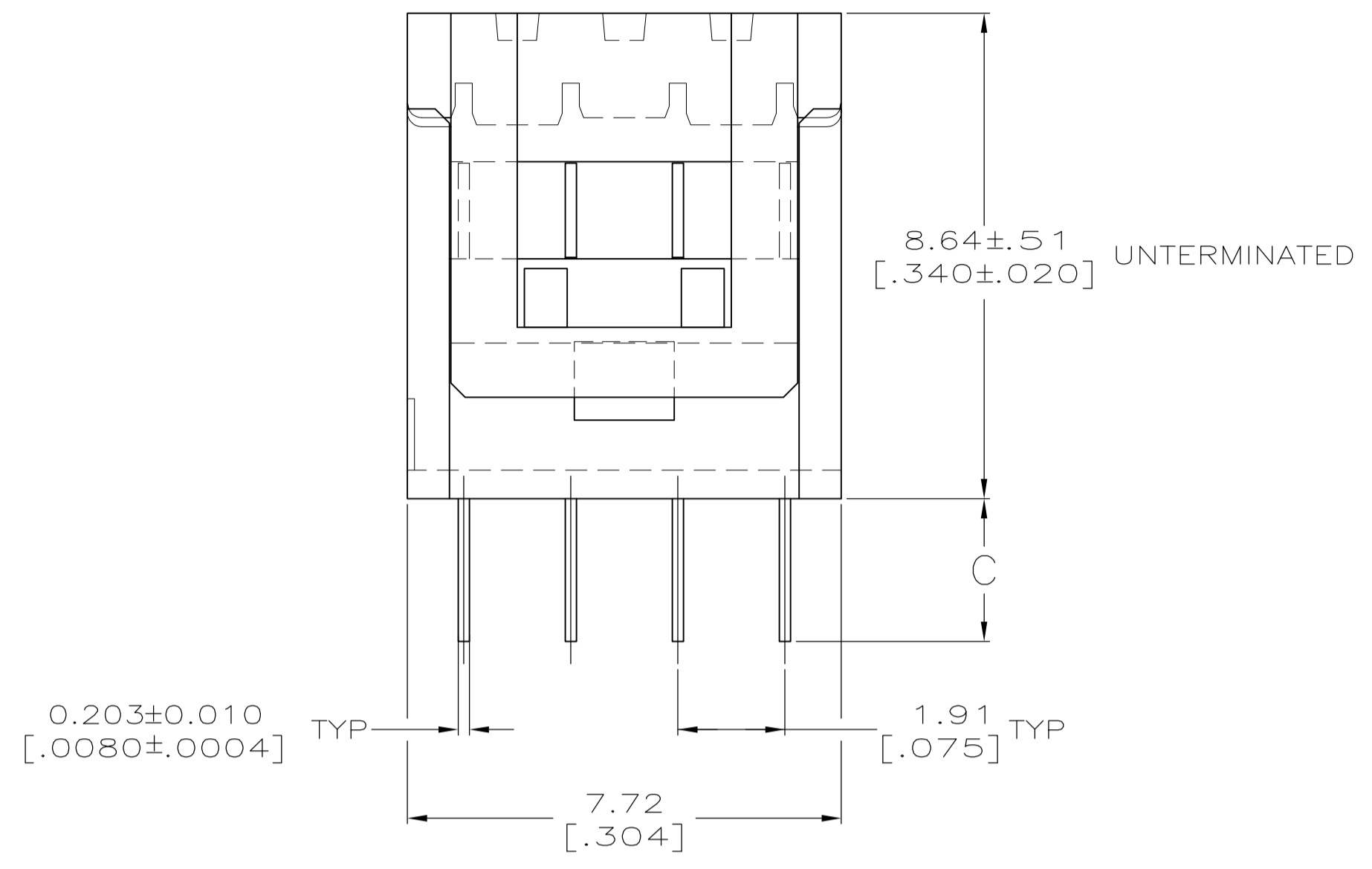
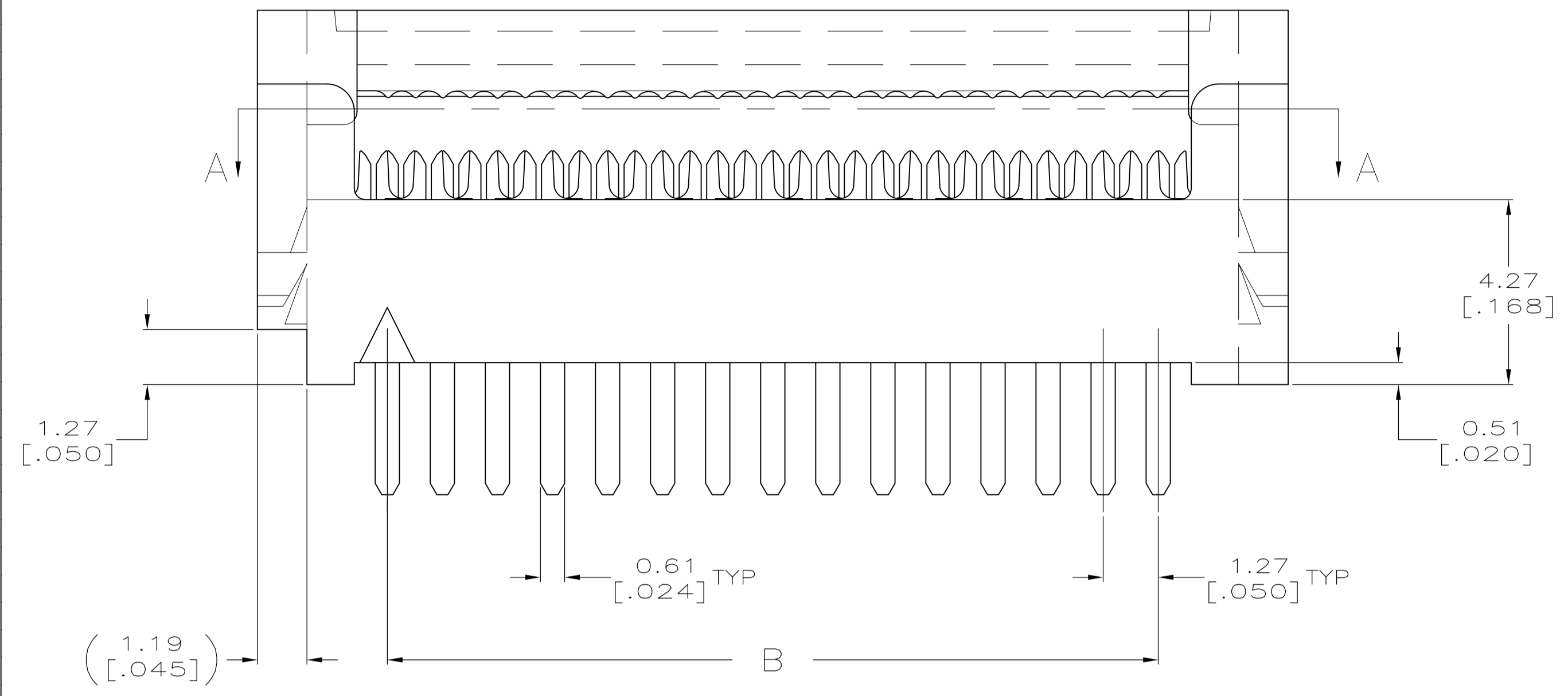

REV	DESCRIPTION	DATE	BY	CHK	APP	
#2	3.30 [.130]	49.53 [1.950]	55.52 [2.186]	80	△ 2-111595-2	
△ SUPERCEDED	#2	2.54 [.100]	41.91 [1.650]	47.90 [1.886]	68	2-111595-1 △
△ SUPERCEDED	#2	2.54 [.100]	16.51 [.650]	22.50 [.886]	28	2-111595-0
	#2	2.54 [.100]	41.91 [1.650]	47.90 [1.886]	68	△ 1-111595-9
	-	1.91 [.075]	36.83 [1.450]	42.82 [1.686]	60	△ 1-111595-8
△ SUPERCEDED	#1	2.54 [.100]	27.94 [1.100]	33.93 [1.336]	46	1-111595-7
	#2	2.54 [.100]	62.23 [2.450]	68.22 [2.686]	100	1-111595-6
	#2	2.54 [.100]	49.53 [1.950]	55.52 [2.186]	80	△ 1-111595-5
△ SUPERCEDED	#2	2.54 [.100]	44.45 [1.750]	50.44 [1.986]	72	1-111595-4
△ SUPERCEDED	#2	2.54 [.100]	39.37 [1.550]	45.36 [1.786]	64	1-111595-3
	#2	2.54 [.100]	36.83 [1.450]	42.82 [1.686]	60	△ 1-111595-2
	#1	2.54 [.100]	30.48 [1.200]	36.47 [1.436]	50	1-111595-1
△ SUPERCEDED	#2	2.54 [.100]	26.67 [1.050]	32.66 [1.286]	44	1-111595-0
	#2	2.54 [.100]	24.13 [.950]	30.12 [1.186]	40	111595-9
	#1	2.54 [.100]	20.32 [.800]	26.31 [1.036]	34	△ 111595-8
	#1	2.54 [.100]	17.78 [.700]	23.77 [.936]	30	111595-7
	#1	2.54 [.100]	15.24 [.600]	21.23 [.836]	26	111595-6
△ SUPERCEDED	#2	2.54 [.100]	13.97 [.550]	19.96 [.786]	24	111595-5
	#2	2.54 [.100]	11.43 [.450]	17.42 [.686]	20	△ 111595-4
	#2	2.54 [.100]	8.89 [.350]	14.88 [.586]	16	111595-3
△ SUPERCEDED	#1	2.54 [.100]	7.62 [.300]	13.61 [.536]	14	111595-2
	#1	2.54 [.100]	5.08 [.200]	11.07 [.436]	10	△ 111595-1

THIS DRAWING IS A CONTROLLED DOCUMENT.

DIMENSIONS: mm [INCHES]	TOLERANCES UNLESS OTHERWISE SPECIFIED:	0. PLC ± -	1. PLC ± -	2. PLC ± .13 [0.005]	3. PLC ± -	4. PLC ± -	ANGLES ± -
-------------------------	--	------------	------------	----------------------	------------	------------	------------

MATERIAL: △ △ △ FINISH: △

THIS DRAWING IS A CONTROLLED DOCUMENT. BY: G. ATTADIA - DOCKS 11-26-04 CHK: C. ROHDE 11-26-04 APP'D: M. WALMSLEY 11-26-04 NAME: AMPMODU® SYSTEM 50, CONNECTOR, PADDLEBOARD

SIZE: A1 CAGE CODE: 00779 DRAWING NO: 111595 RESTRICTED TO: CUSTOMER DRAWING SCALE: 10:1 SHEET 1 OF 2 REV: N3

LOC		DIST		REVISIONS			
P	LTR	DESCRIPTION	DATE	DNW	APVD		
		SEE SHEET 1					

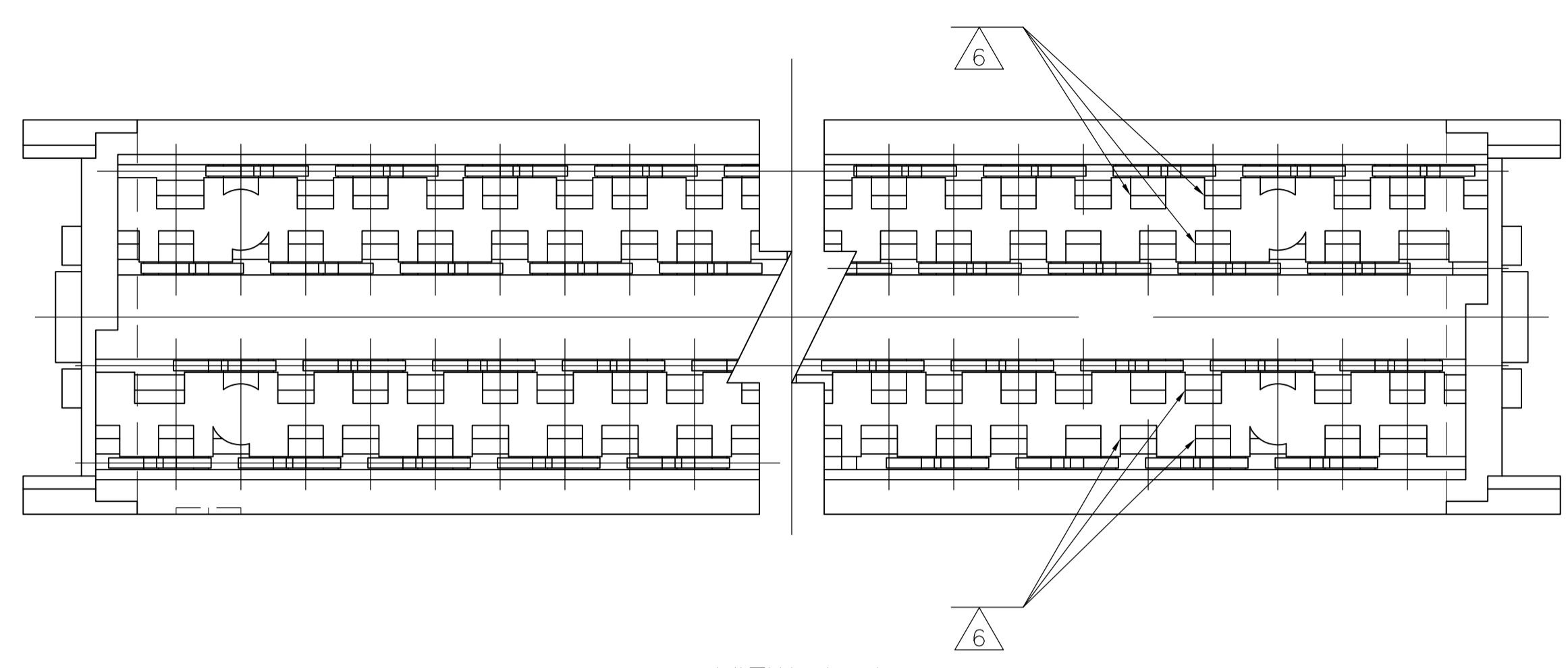

VIEW A-A  
 (COVER REMOVED FOR CLARITY)

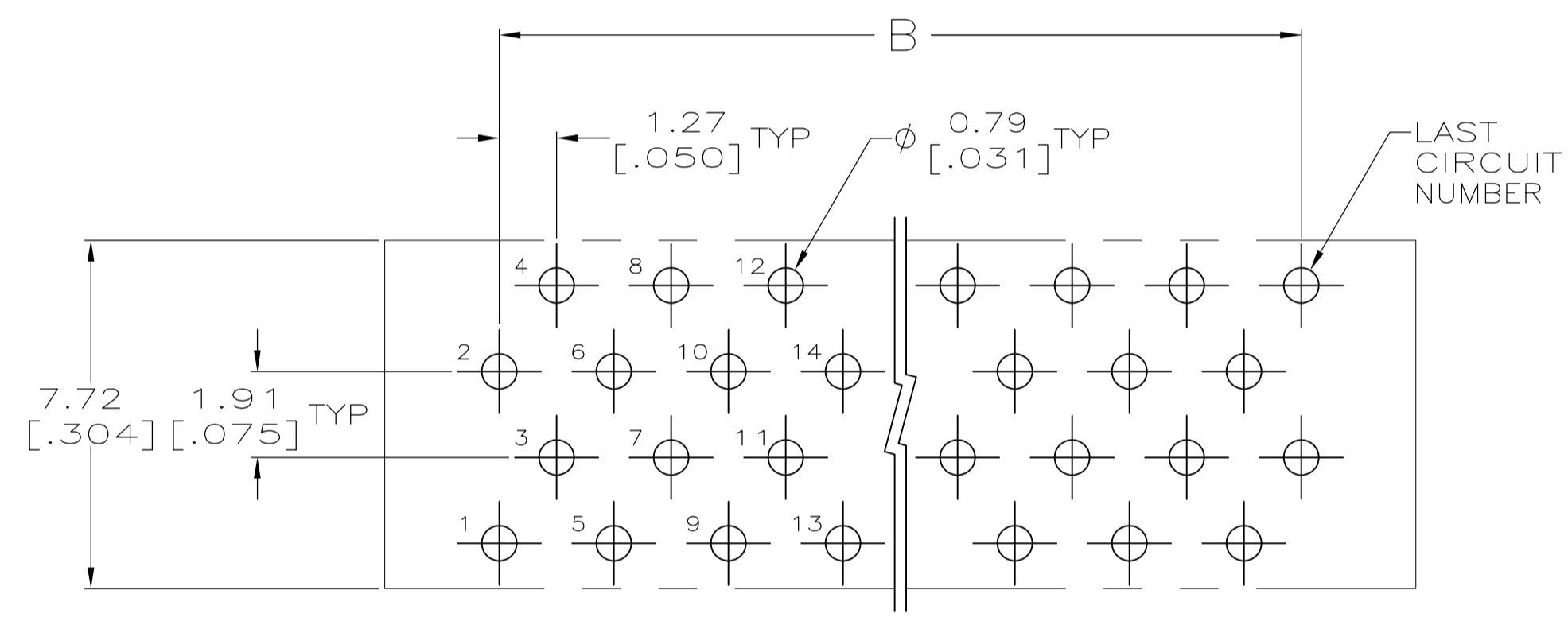

PRINTED CIRCUIT BOARD HOLE LAYOUT #2

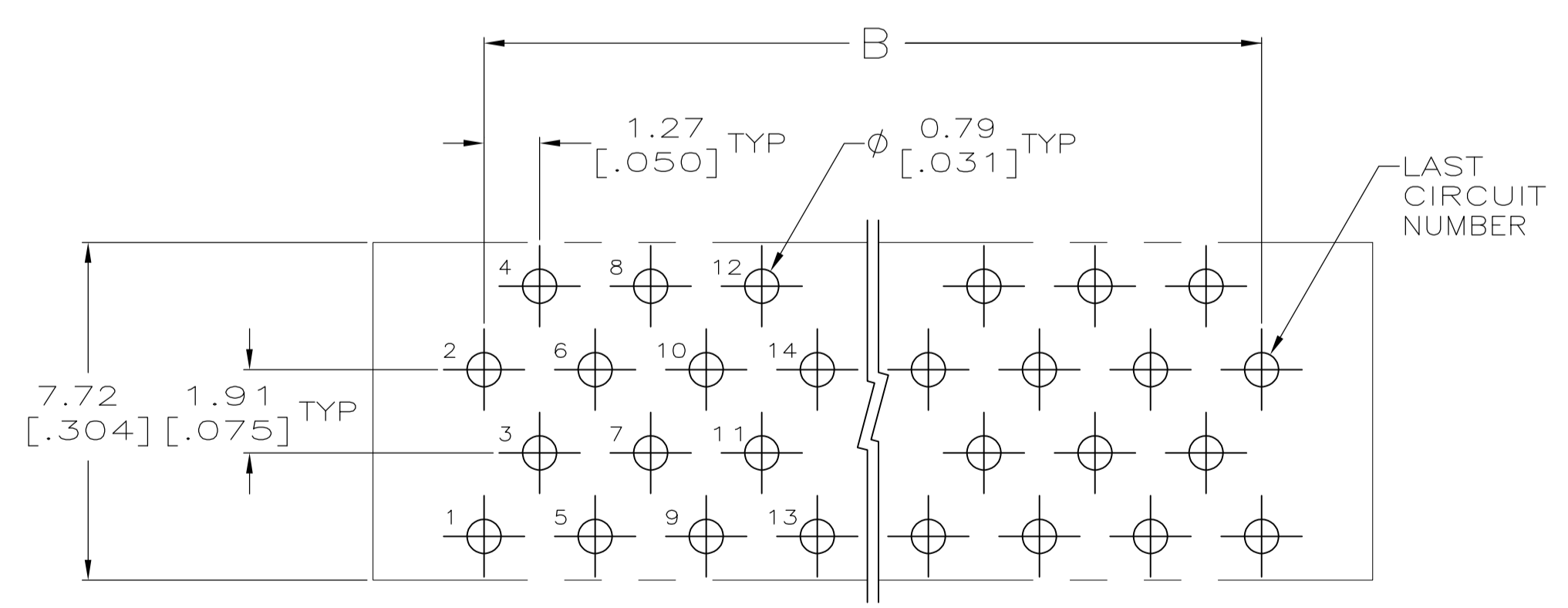

PRINTED CIRCUIT BOARD HOLE LAYOUT #1

THIS DRAWING IS A CONTROLLED DOCUMENT.		DIN G. ATTADIA 26NOV04	Tyco Electronics Corporation Harrisburg, PA 17105-3608	
DIMENSIONS: mm [INCHES]		CHK C. ROHDE 26NOV04	APVD M. WALMSLEY 26NOV04	
TOLERANCES UNLESS OTHERWISE SPECIFIED:		NAME AMP/Modu SYSTEM 50, CONNECTOR, PADDLEBOARD		
0. PLC ± -		PRODUCT SPEC		
1. PLC ± -		APPLICATION SPEC		
2. PLC ± -		SIZE A1		
3. PLC ± -		CAGE CODE 00779		
4. PLC ± -		DRAWING NO 111595		
ANGLES ± -		RESTRICTED TO		
MATERIAL SEE SHEET 1	FINISH SEE SHEET 1	WEIGHT -	SCALE 10:1	SHEET 2 OF 2
CUSTOMER DRAWING		REV N3		

## X-ON Electronics

Largest Supplier of Electrical and Electronic Components

*Click to view similar products for [Headers & Wire Housings](#) category:*

*Click to view products by [TE Connectivity](#) manufacturer:*

Other Similar products are found below :

[95000-104TRLF](#) [10135584-644402LF](#) [DF62W-EP2022PCA](#) [95000-106TRLF](#) [DF62W-2022SCA](#) [DF62W-EP2022PC](#) [2203348](#) [DF62W-2022SC](#) [1084018](#) [1029039](#) [1084017](#) [802-10-012-10-002000](#) [1112640](#) [1112639](#) [000-34000](#) [0009482033](#) [0009507031](#) [57102-S06-03LF](#) [57202-S52-04LF](#) [PCN6-15S-2.5E](#) [0039019024](#) [58102-G61-06LF](#) [582553-1](#) [0009508121](#) [0050291907](#) [018731A](#) [LY20-4P-DT1-P1E-BR](#) [02.125.8002.8](#) [60101931](#) [60598-1 \(Cut Strip\)](#) [M1625-3R/100](#) [61062-3](#) [61082-181009](#) [636-1427](#) [638009-1](#) [641938-9](#) [641991-4](#) [644168-1](#) [647662-1](#) [65039-019ELF](#) [65817-002LF](#) [65817-015LF](#) [65863-015LF](#) [66207-023LF](#) [67016-026LF](#) [67046-001LF](#) [67095-007LF](#) [68002-116](#) [68016-236H](#) [68648-049](#)