

THIS DRAWING IS UNPUBLISHED.
VERTRÄULICHE UNVERÖFFENTLICHTE ZEICHNUNG

RELEASED FOR PUBLICATION
FREI FÜR VERÖFFENTLICHUNG

ALL RIGHTS RESERVED.
ALLE RECHTE VORBEHALTEN.

MATED WITH:
PASSEND ZU:

PROJEKT NR.:		REVISIONS ÄNDERUNGEN			
P	LTR	DESCRIPTION BESCHREIBUNG	DATE	DWN	APVD
E		ECR-14-013059	02SEP2014	ABV	SA
E1		ECR-15-015157	20OCT2015	ABV	SA

Kodierungen
CODINGS
2:1

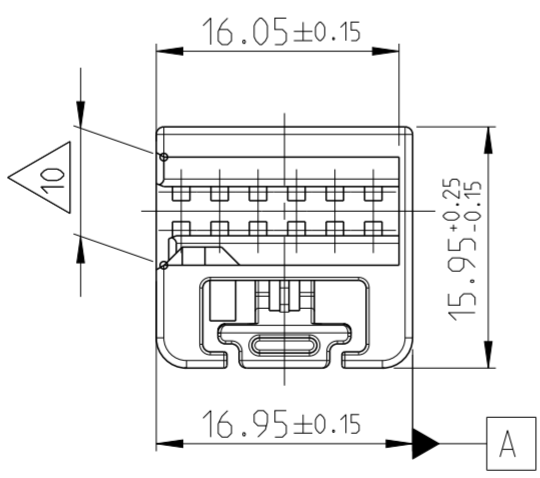
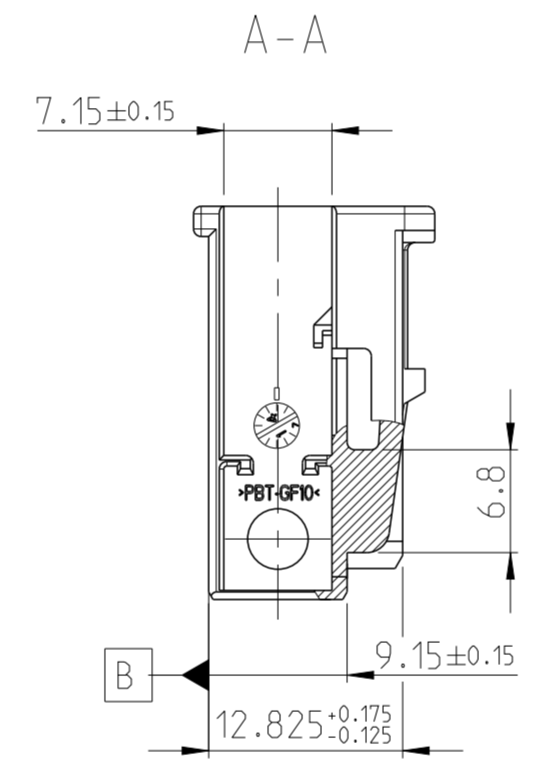
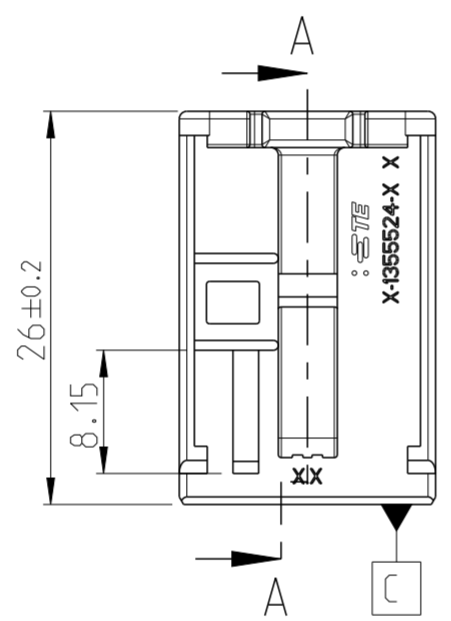
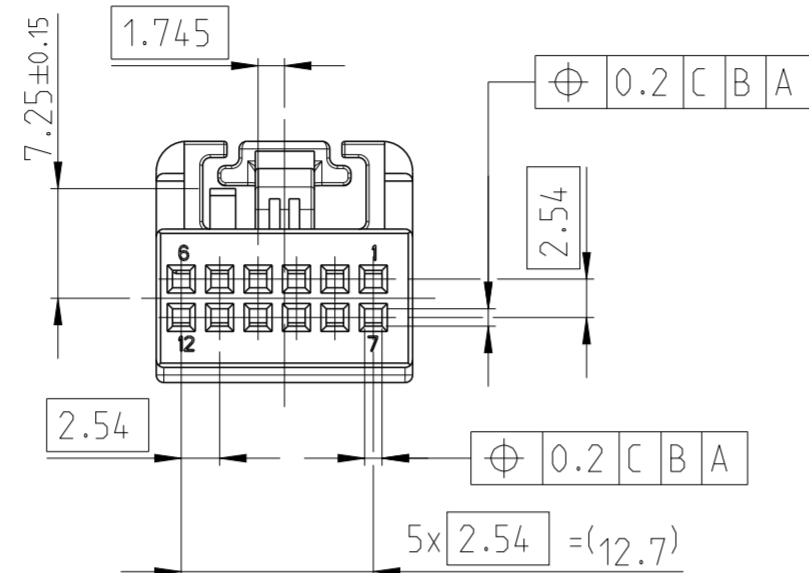
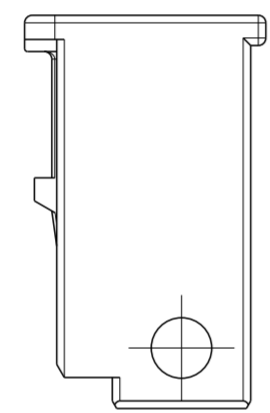
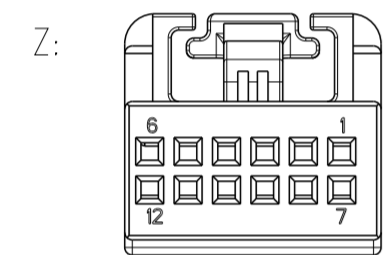
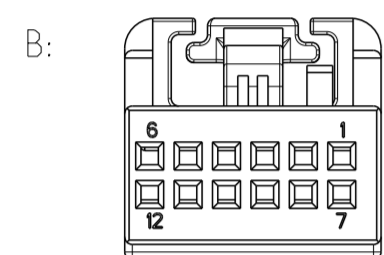
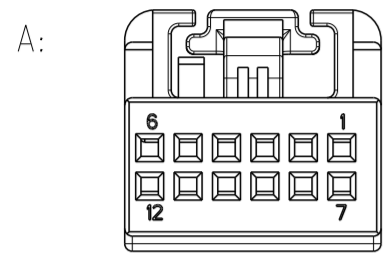

Bemerkungen
NOTES

- Passend zu Buchsengehäuse, siehe Zeichnung TE: 1394048
SUITABLE TO SOCKET HOUSING. SEE DRAWING
- Änderung nur mit Zustimmung der freigebenden Fachabteilung
CHANGES ONLY WITH APPROVAL OF THE RESPONSIBLE DEPARTMENT
- Einzelheiten der Ausführung bleiben dem Hersteller überlassen
THE MANUFACTURER CAN CHANGE DETAILS OF THE DESIGN
- Massgebend ist der deutsche Text
ONLY THE GERMAN-LANGUAGE VERSION SHALL BE BINDING
- Formteilungsgrat zulässig MAX. 0.3
PART LINE PERMITTED
- Formteilungsversatz zulässig MAX. 0.3
SPLIT LINE PERMITTED
- Verpackung: Schuetttgut
PACKAGING: LOOSE PIECE
- Zulässiger Regeneratanteil MAX. 25%
RECYCLED MATERIAL PERMISSIBLE
- Ausführung Lieferantenlogo wahlweise
SUPPLIER LOGO VERSION OPTIONAL
- Verzug zulässig bis max. ±0.5 mm (E1)
WARPAGE PERMITTED TO MAX. ±0.5 mm (E1)

1- -3 wie gezeichnet
AS SHOWN

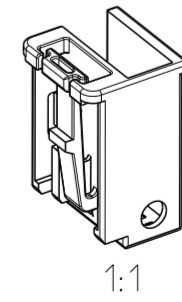

TE BESTELL-NR. ORDER NO.	REV.	KOD. COD.	BENENNUNG DESCRIPTION	OBERFLÄCHE SURFACE FARBE/COLOUR	ART KIND GEWICHT WEIGHT	GRAMM	Passend zu: SUITABLE FOR: Stiftwanne PIN HEADER
9-1355524-3	E	Z	Abdeckkappe/COVER	wasserblau/WATER BLUE	S	2.3	1241768-2 1241768-1
2-1355524-3	E	B	Abdeckkappe/COVER	natur/NATURAL	S	2.3	
1-1355524-3	E	A	Abdeckkappe/COVER	schwarz/BLACK	S	2.3	

TOLERANCING ISO 8015 TOLERIERUNG ISO 8015		TOLERANCES UNLESS OTHERWISE SPECIFIED ACC. TO DIN 16901-140⑩CENTRIC TO NOMINAL DIMENSION. EDITION 1982-11 SHALL APPLY. Freimass toleranzen nach DIN 16901-140⑩. Es gilt die Ausgabe 1982-11.	
DIESE ZEICHNUNG IST EIN KONTROLLIERTES DOKUMENT. BEMASSUNGEN UND TOLERANZEN GEMAESS GPS (ISO STANDARDS).		THIS DRAWING IS A CONTROLLED DOCUMENT. DIMENSIONING AND TOLERANCING PER GPS (ISO STANDARDS).	
DIMENSIONS: MASSEINHEITEN: (MM)		TOLERANCES UNLESS OTHERWISE SPECIFIED: ALLGEMEINTOLERANZEN	
MATERIAL PBT-GF10		DWN: 0.Patschula 20JUL99 CHK: J.Hahn - APVD: - NAME: - PRODUCT SPEC: 108-18157 APPLICATION SPEC: 114-18351 WEIGHT: - CUSTOMER DRAWING	
SCALE: 2:1		SHEET: 1 OF 1	
RESTRICTED TO NUR FÜR		REV: E1	

STE TE Connectivity

MICRO QUADLOK SYSTEM
COVER, 12 POS
Abdeckkappe, 12-pol.

X-ON Electronics

Largest Supplier of Electrical and Electronic Components

Click to view similar products for [Automotive Connectors](#) category:

Click to view products by [TE Connectivity](#) manufacturer:

Other Similar products are found below :

[003-018-000](#) [60403001](#) [60993906-B](#) [M902-2131](#) [M902-2161](#) [M902-2344](#) [72.330.1035.1](#) [73.353.4028.0](#) [F119300-B](#) [F166900](#) [F258300-B](#)
[F358300-B](#) [F407400](#) [F444110](#) [F487000](#) [F509500B-B](#) [827153-1](#) [8N1515-32-24P](#) [9-1326729-8](#) [925474-1](#) [928905-1](#) [964562-4](#) [968782-1](#)
[GT17SA-8DS-HU](#) [98891-1012](#) [98947-1016](#) [12004147](#) [12004475-L](#) [12010290](#) [12010309-B](#) [12015454](#) [12020219-B](#) [12041318-B](#) [12052225-](#)
[L](#) [12052466](#) [12064869](#) [12004327-B](#) [12015308](#) [12015384](#) [12015909](#) [1-21030-1](#) [12041254](#) [12041318](#) [12047946-B](#) [12047957](#) [12047957-L](#)
[12059473](#) [12066261](#) [12110546](#) [12110546-B](#)