

THIS DRAWING IS UNPUBLISHED. RELEASED FOR PUBLICATION
 © COPYRIGHT - By - ALL RIGHTS RESERVED.

LOC		DIST		REVISIONS			
P	LTR	DESCRIPTION		DATE	DWN	APVD	
	D9	REVISED PER ECO-12-012202		03JUL12	KH	MS	







PHYSICAL PROPERTIES:
 HOUSING MATERIAL: PBT
 FLAMMABILITY: UL94V-0
 COLOR: BLACK











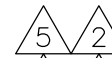

TERMINAL:
 TERMINALS: BRASS, TIN PLATED
 SCREWS: 6-32, STEEL, NICKEL PLATED

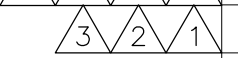
MECHANICAL:
 PITCH (TERMINAL SPACING): 9.50mm (.374")
 WIRE RANGE: 12-22 AWG
 RECOMMENDED TIGHTENING TORQUE: 12IN-LBS MAX.

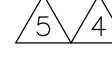
ELECTRICAL PROPERTIES:
 MAXIMUM CURRENT: 20A
 OPERATING VOLTAGE: 300V

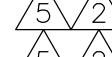
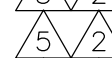
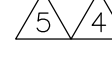
ENVIRONMENTAL PROPERTIES:
 OPERATING TEMP RANGE: -40°C TO 120°C

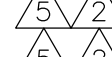
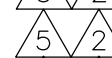
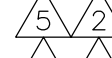
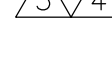
-  SCREWS ON ONE SIDE IN WIRE READY POSITION.
-  SEE FIGURE.
-  WHITE INK STAMP.
-  NICKEL PLATED BRASS SCREWS.
-  PRELIMINARY PART NUMBER.
-  TE CONNECTIVITY LOGO LOCATED APPROXIMATE AREA SHOWN.

LOC	DIST	P	LTR	DESCRIPTION	DATE	DWN	APVD
				 104.7 112.2 - - 10 4-1546307-7			
				 104.7 112.2 - - 10 4-1546307-6			
				 104.7 112.2 - - 10 4-1546307-5			
				 104.7 112.2 - - 10 3-1546307-3			
				104.7 112.2 - - 10 1-1546307-0			
				 95.2 102.7 - 9 9 5-1546307-0			
				 95.2 102.7 4 9 9 4-1546307-9			
				 95.2 102.7 4 9 9 4-1546307-8			
				95.2 102.7 - - 9 1546307-9			
				85.7 93.2 - - 8 1546307-8			
				76.2 83.7 - - 7 1546307-7			
				 66.7 74.2 - - 6 4-1546307-4			
				66.7 74.2 - - 6 1546307-6			
				 57.2 64.7 - - 5 4-1546307-3			
				 57.2 64.7 - - 5 4-1546307-2			
				 57.2 64.7 - - 5 4-1546307-1			
				 57.2 64.7 - - 5 4-1546307-0			
				 57.2 64.7 - - 5 3-1546307-9			
				57.2 64.7 - - 5 1546307-5			
				 47.7 55.2 - - 4 3-1546307-2			
				47.7 55.2 - - 4 1546307-4			
				 38.2 45.7 - - 3 3-1546307-8			
				 38.2 45.7 - - 3 3-1546307-7			
				 38.2 45.7 - - 3 3-1546307-6			
				 38.2 45.7 - - 3 3-1546307-5			
				 38.2 45.7 - - 3 3-1546307-4			
				38.2 45.7 - - 3 1546307-3			
				28.7 36.2 - - 2 1546307-2			
				DIM B DIM A QC TAB .187 45° (2) QC TAB .187 FLAT (1) NO OF POSN PART NUMBER			

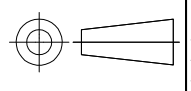
THIS DRAWING IS A CONTROLLED DOCUMENT.		DWN S SCHLEGEL 20AUG2002		 TE Connectivity			
DIMENSIONS: mm		TOLERANCES UNLESS OTHERWISE SPECIFIED:					
		0 PLC ± - 1 PLC ± 0.3 2 PLC ± 0.25 3 PLC ± - 4 PLC ± - ANGLES ± 2°		PRODUCT SPEC		NAME	
MATERIAL		FINISH		APPLICATION SPEC		9.50MM (.374) DBL ROW BARRIER STRIP W/ WASHER	
-		-		WEIGHT -		SIZE A3 CAGE CODE 00779 DRAWING NO C-1546307 RESTRICTED TO -	
CUSTOMER DRAWING				SCALE 1:1		SHEET 1 OF 3 REV D9	

THIS DRAWING IS UNPUBLISHED. RELEASED FOR PUBLICATION
 © COPYRIGHT - By - ALL RIGHTS RESERVED.

LOC	DIST	REVISIONS			
P	LTR	DESCRIPTION	DATE	DWN	APVD
-	-	SEE SHEET 1	-	-	-



3-1546307-1



3-1546307-5



3-1546307-2

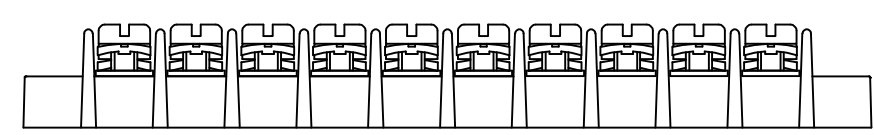
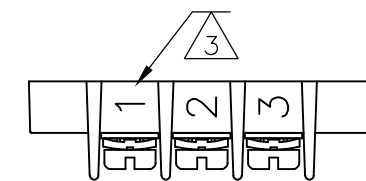
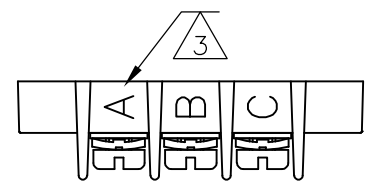

3-1546307-3



3-1546307-7



3-1546307-8



3-1546307-6

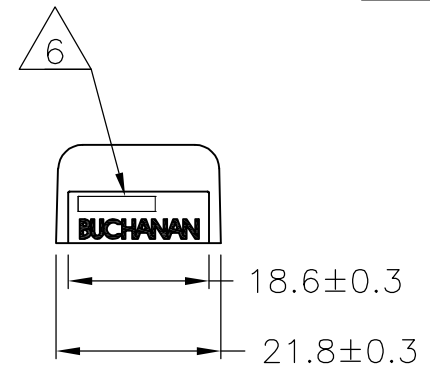

294.7	302.2	-	-	30	3-1546307-0
285.2	292.7	-	-	29	2-1546307-9
275.7	283.2	-	-	28	2-1546307-8
266.2	273.7	-	-	27	2-1546307-7
256.7	264.2	-	-	26	2-1546307-6
247.2	254.7	-	-	25	2-1546307-5
237.7	245.2	-	-	24	2-1546307-4
228.2	235.7	-	-	23	2-1546307-3
218.7	226.2	-	-	22	2-1546307-2
209.2	216.7	-	-	21	2-1546307-1
199.7	207.2	-	-	20	3-1546307-1
199.7	207.2	-	-	20	2-1546307-0
190.2	197.7	-	-	19	1-1546307-9
180.7	188.2	-	-	18	1-1546307-8
171.2	178.7	-	-	17	1-1546307-7
161.7	169.2	-	-	16	1-1546307-6
152.2	159.7	-	-	15	1-1546307-5
142.7	150.2	-	-	14	1-1546307-4
133.2	140.7	-	-	13	1-1546307-3
123.7	131.2	-	-	12	1-1546307-2
114.2	121.7	-	-	11	1-1546307-1
DIM B	DIM A	QC TAB .187 45° (2)	QC TAB .187 FLAT (1)	NO OF POSN	PART NUMBER

THIS DRAWING IS A CONTROLLED DOCUMENT.		DWN S SCHLEGEL 20AUG2002	TE Connectivity		
DIMENSIONS: mm		CHK C RICHARD 8/20/02			
TOLERANCES UNLESS OTHERWISE SPECIFIED:		APVD C RICHARD 8/20/02	NAME 9.50MM (.374) DBL ROW BARRIER STRIP W/ WASHER		
0 PLC ± - 1 PLC ± 0.3 2 PLC ± 0.25 3 PLC ± - 4 PLC ± - ANGLES ± 2°		PRODUCT SPEC -	SIZE A3 CAGE CODE 00779 DRAWING NO C-1546307 RESTRICTED TO -		
MATERIAL -		APPLICATION SPEC -	SCALE 1:1 SHEET 2 OF 3 REV D9		
FINISH -		WEIGHT -	CUSTOMER DRAWING		

THIS DRAWING IS UNPUBLISHED.

RELEASED FOR PUBLICATION

ALL RIGHTS RESERVED.

© COPYRIGHT - By -

LOC -

DIST -

P

LTR

REVISIONS

DESCRIPTION

DATE

DWN

APVD

SEE SHEET 1

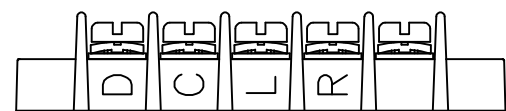
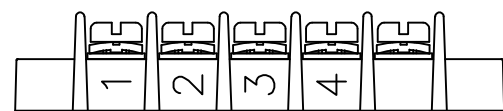
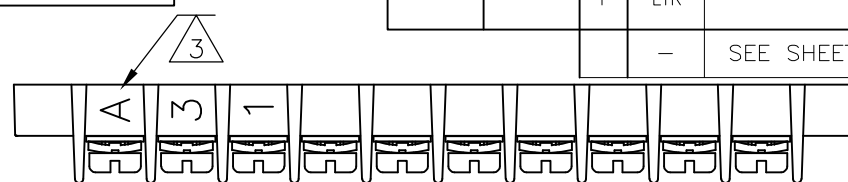
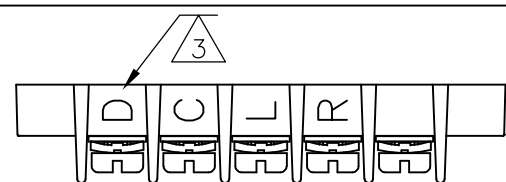
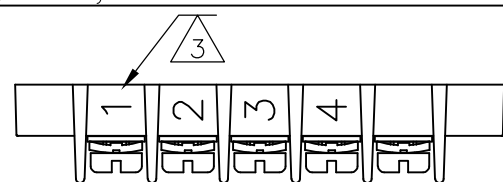

4-1546307-2

4-1546307-3

4-1546307-7

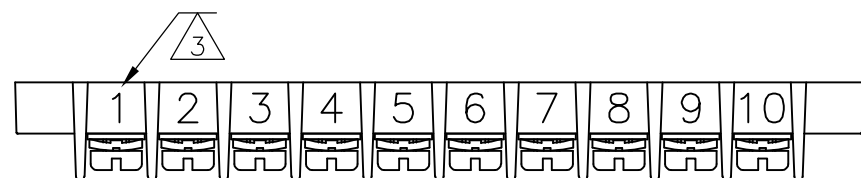

4-1546307-6

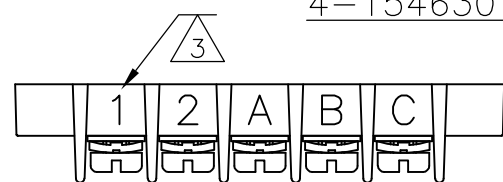

4-1546307-0

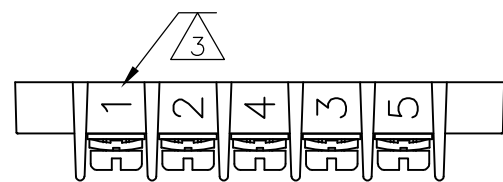

4-1546307-1

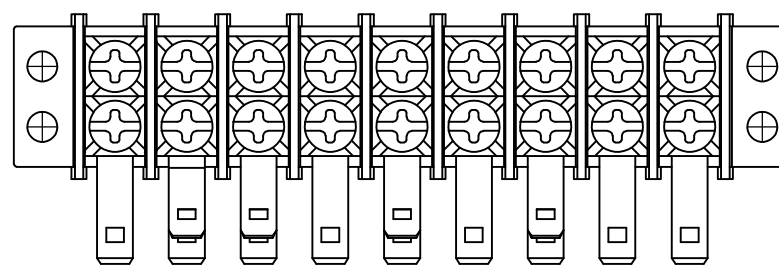
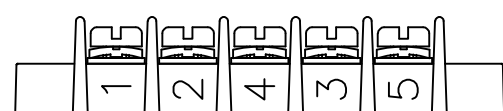

4-1546307-8

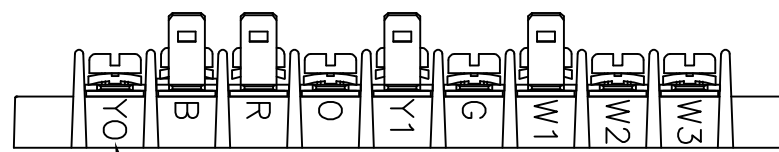

MARK BOTH SIDES

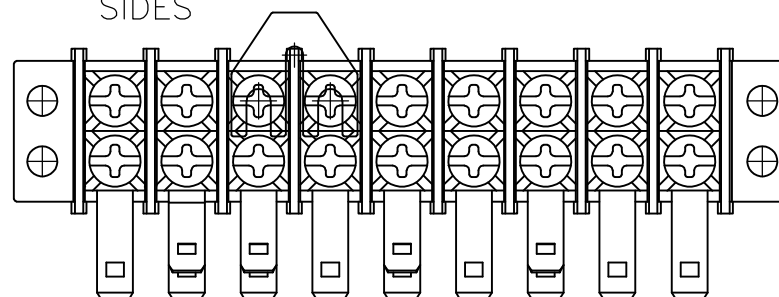

4-1546307-9

MARK BOTH SIDES

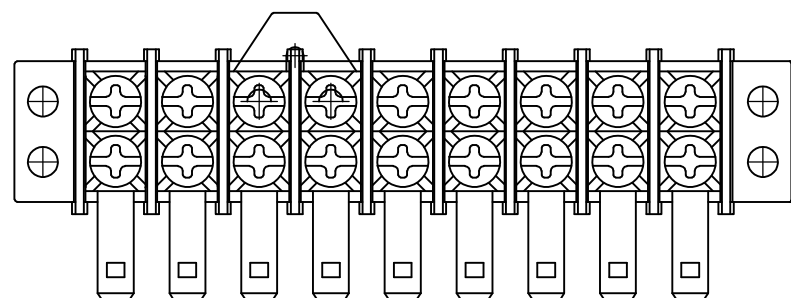
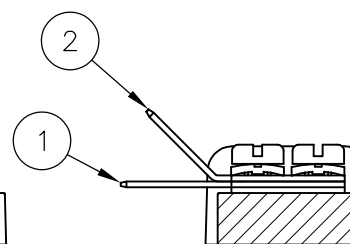
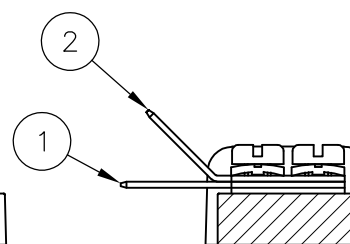

5-1546307-0

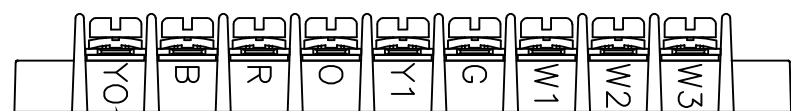

MARK BOTH SIDES

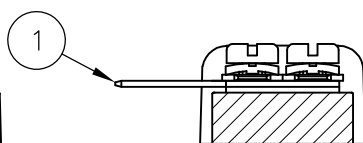

THIS DRAWING IS A CONTROLLED DOCUMENT.

DIMENSIONS:

mm

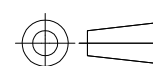

TOLERANCES UNLESS OTHERWISE SPECIFIED:

0 PLC	± -
1 PLC	± 0.3
2 PLC	± 0.25
3 PLC	± -
4 PLC	± -
ANGLES	± 2'
FINISH	-

MATERIAL

-

DWN 20AUG2002

S SCHLEGEL

CHK 8/20/02

C RICHARD

APVD 8/20/02

C RICHARD

PRODUCT SPEC

-

APPLICATION SPEC

-

WEIGHT

-

CUSTOMER DRAWING

STE TE Connectivity

9.50MM (.374) DBL ROW BARRIER STRIP W/ WASHER

SIZE	CAGE CODE	DRAWING NO	RESTRICTED TO
A3	00779	C-1546307	-

SCALE 1:1 SHEET 3 OF 3 REV D9

X-ON Electronics

Largest Supplier of Electrical and Electronic Components

Click to view similar products for [Barrier Terminal Blocks](#) category:

Click to view products by [TE Connectivity](#) manufacturer:

Other Similar products are found below :

[CR151D20104](#) [670A-RZ-15-KT20](#) [6C1N03](#) [6PCR-02](#) [6PCR-02-008](#) [6PCR-05-008](#) [6PCR-08-008](#) [6PCR-09-008](#) [6PCR-13-006](#) [6PCR-15-006](#) [6PCR-21-006](#) [6PCV-06-008](#) [6PCV-06-716](#) [6PCV-09-001](#) [6PCV-10-009](#) [6PCV-15-008](#) [6PCV-17-1206](#) [6PCV-20-323](#) [6PCV-20-720](#) [6PCV-30-006](#) [6STR-06-006](#) [6STR-08-006](#) [6STR-12-008](#) [6STR-13-006](#) [6STR-14-008](#) [6STR-16-008](#) [6STR-17-008](#) [6STR-21-008](#) [6STR-25-008](#) [6STR-27-008](#) [6STV-03-006](#) [6STV-03-008](#) [6STV-04-006](#) [6STV-09-006](#) [6STV-10-006](#) [6WWR-03-693](#) [6WWV-12-008](#) [72212603](#) [72504-C-50](#) [72506-C](#) [72507-C-50](#) [73203](#) [75505-C](#) [75505-C-50](#) [75510-C](#) [77010-50](#) [7C1N08](#) [812-GP-3/4ST-09](#) [8-1437402-5](#) [8PCR-06-006](#)