

THIS DRAWING IS UNPUBLISHED. RELEASED FOR PUBLICATION
 © COPYRIGHT - By - ALL RIGHTS RESERVED.

LOC	DIST	REVISIONS					
		P	LTR	DESCRIPTION	DATE	DWN	APVD
FT	0	K18		REVISED PER ECO-11-004587	11MAR11	RK	HMR

PHYSICAL PROPERTIES:
 HOUSING MATERIAL: THERMOPLASTIC, PC
 FLAMABILITY: UL94V-0
 COLOR: BLACK

TERMINAL:
 TERMINALS: BRASS, TIN PLATED
 SCREWS: 6-32 STEEL, NICKEL PLATED

MECHANICAL:
 PITCH: .437
 WIRE RANGE: 14-22 AWG
 RECOMMENDED TIGHTENING TORQUE: 12IN-LB

ELECTRICAL PROPERTIES:
 MAX CURRENT: 25A
 OPERATING VOLTAGE: 300V

ENVIRONMENTAL PROPERTIES:
 OPERATING TEMP: -40°C TO 120°C

- 1 SEE FIGURE.
- 2 PRELIMINARY PART NUMBER.
- 3 STAINLESS STEEL SCREWS.
- 4 WHITE INK STAMP.
- 5 TE CONNECTIVITY LOGO LOCATED APPROXIMATE AREA.

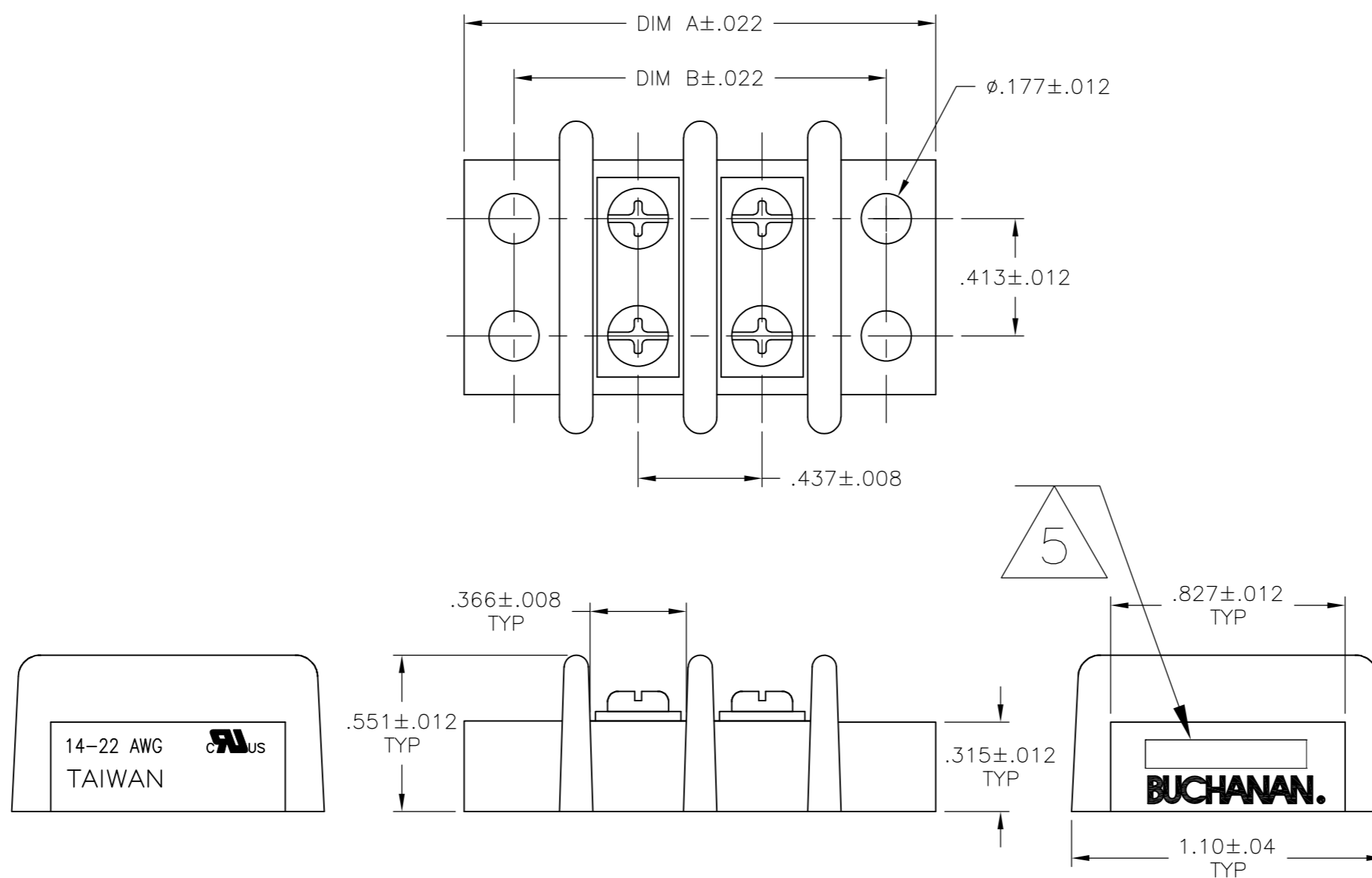

5.646	5.992	12	4-1546670-2
9.142	9.488	20	2-1546670-0
8.705	9.051	19	1-1546670-9
8.268	8.614	18	3-1546670-0
8.268	8.614	18	1-1546670-8
7.831	8.177	17	1-1546670-7
7.394	7.740	16	1-1546670-6
6.957	7.303	15	1-1546670-5
6.520	6.866	14	1-1546670-4
6.083	6.429	13	1-1546670-3
5.646	5.992	12	1-1546670-2
5.209	5.555	11	1-1546670-1
4.772	5.118	10	4-1546670-3
4.772	5.118	10	3-1546670-8
4.772	5.118	10	1-1546670-0
4.335	4.681	9	3-1546670-5
4.335	4.681	9	3-1546670-2
4.335	4.681	9	1546670-9
3.898	4.244	8	4-1546670-1
3.898	4.244	8	3-1546670-6
3.898	4.244	8	3-1546670-4
3.898	4.244	8	3-1546670-3
3.898	4.244	8	1546670-8
3.461	3.807	7	1546670-7
3.024	3.370	6	3-1546670-1
3.024	3.370	6	1546670-6
2.587	2.933	5	2-1546670-8
2.587	2.933	5	2-1546670-7
2.587	2.933	5	1546670-5
2.496	2.933	4	3-1546670-9
2.150	2.496	4	2-1546670-9
2.150	2.496	4	1546670-4
1.713	2.059	3	1546670-3
1.276	1.622	2	1546670-2
DIM B	DIM A	NO OF POS	PART NUMBER

THIS DRAWING IS A CONTROLLED DOCUMENT.

DWN	S SCHEGEL	4/4/03
CHK	C RICHARD	4/4/03
APVD	C RICHARD	4/4/03

TE Connectivity

DOUBLE ROW BARRIER STRIP W/ BINDING HD SCREW, .437 SPACING

SIZE	A2	CAGE CODE	00779	DRAWING NO	1546670	RESTRICTED TO	-
SCALE	NTS	SHEET	1 of 3	REV	K18		

CUSTOMER DRAWING

THIS DRAWING IS UNPUBLISHED. RELEASED FOR PUBLICATION
 © COPYRIGHT - By - ALL RIGHTS RESERVED.

LOC		DIST		REVISIONS			
P	LTR	DESCRIPTION	DATE	DWN	APVD		
FT	0	SEE SHEET 1	-	-	-		

DOUBLE SIDED, DOUBLE HOLE
QC TAB, QTY 5

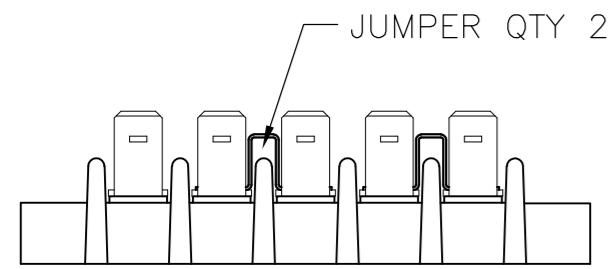
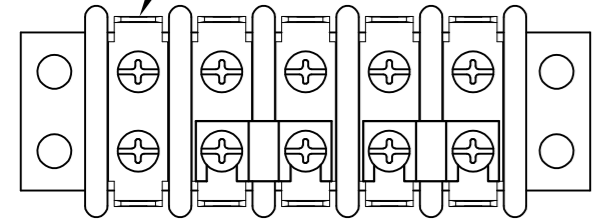

2-1546670-7

DOUBLE SIDED, DOUBLE HOLE
QC TAB, QTY 5

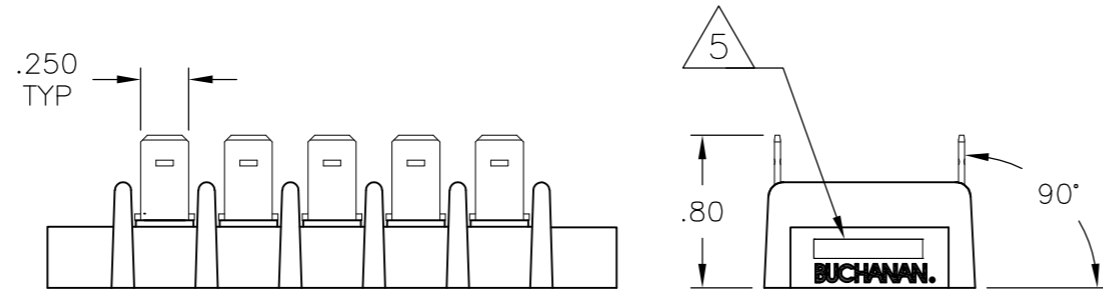
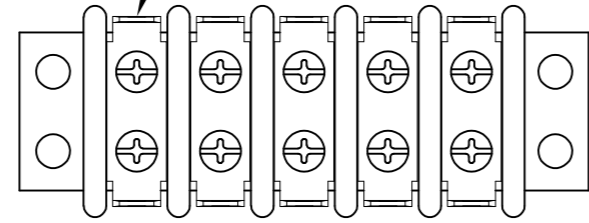

2-1546670-8

JUMPER, QTY 1

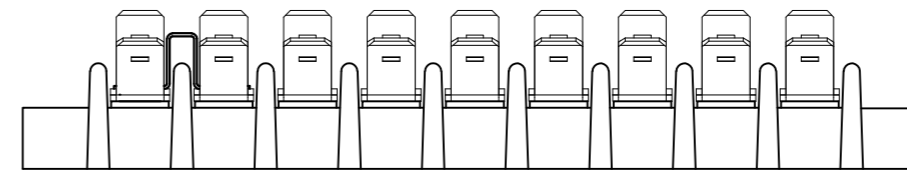
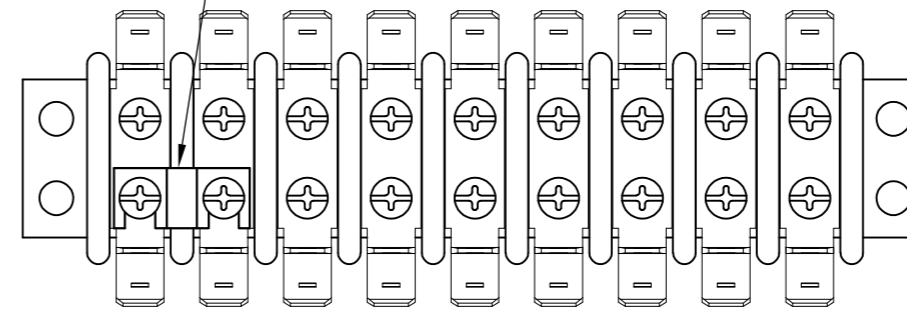

3-1546670-2

DOUBLE SIDED, DOUBLE HOLE
45° QC TAB, QTY 9

DOUBLE SIDED, DOUBLE HOLE
90° QC TAB, QTY 9

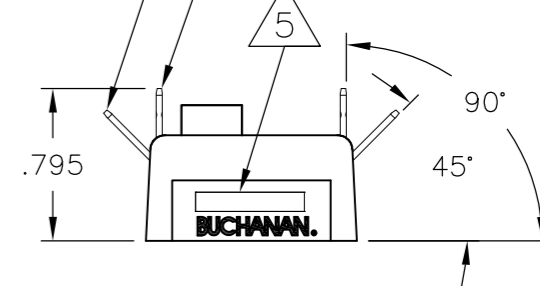

3-1546670-2

DOUBLE SIDED, DOUBLE HOLE
QC TAB, QTY 5

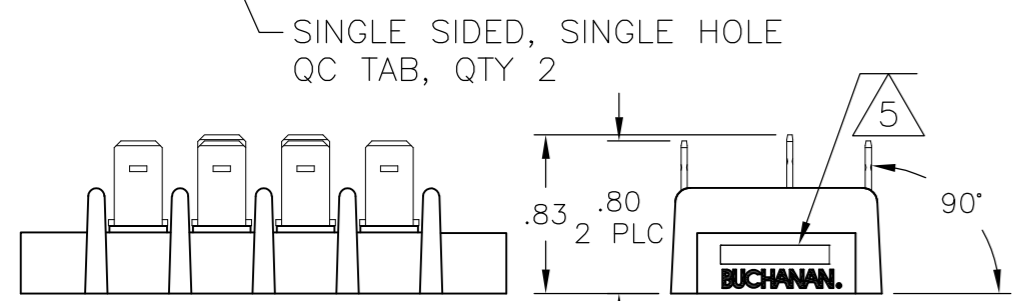
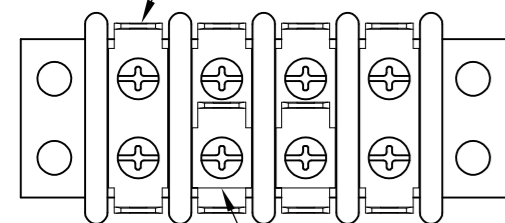

2-1546670-9

SINGLE SIDED, DOUBLE HOLE
QC TAB, QTY 6

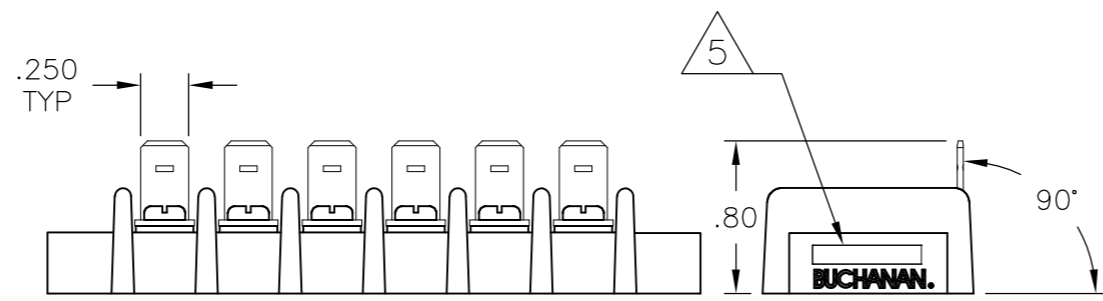
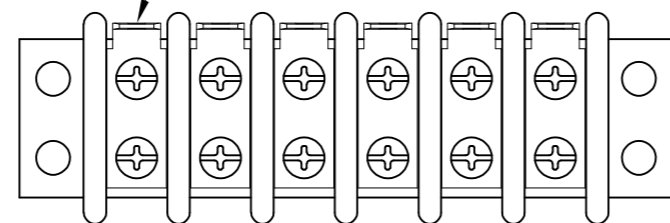

3-1546670-1

DOUBLE SIDED, DOUBLE HOLE
FLAT QC TAB, QTY 8.

JUMPER, QTY 2

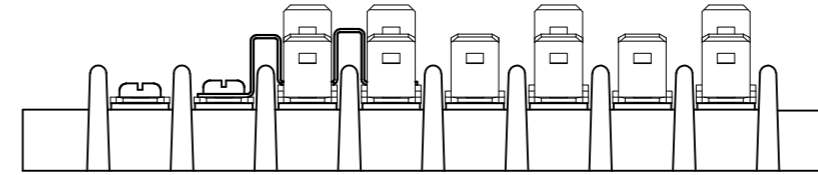
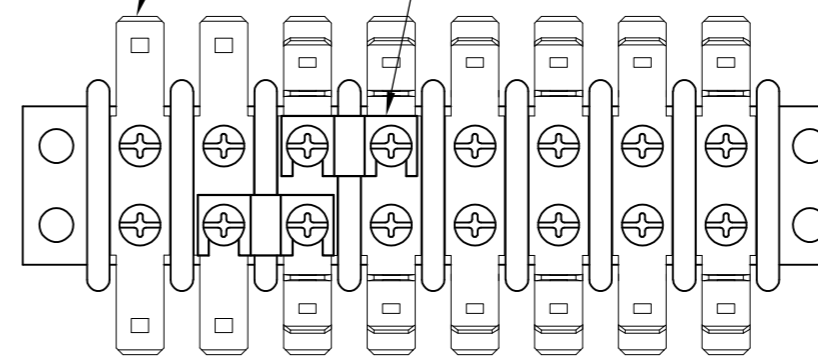

3-1546670-3

DOUBLE SIDED, DOUBLE HOLE
45° QC TAB, QTY 6

DOUBLE SIDED, DOUBLE HOLE
90° QC TAB, QTY 4

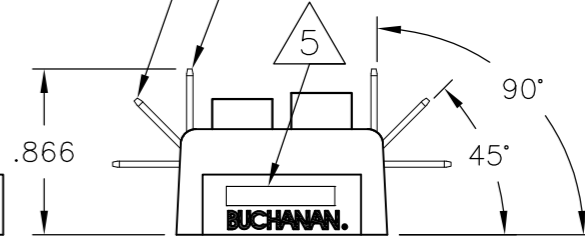

3-1546670-3

SINGLE SIDED, DOUBLE HOLE
QC TAB, QTY 18

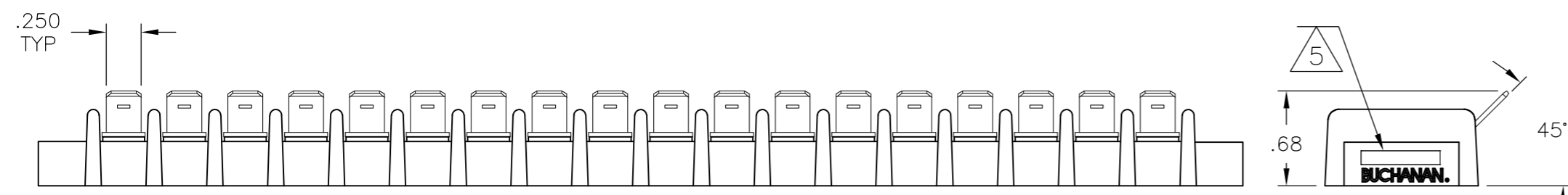
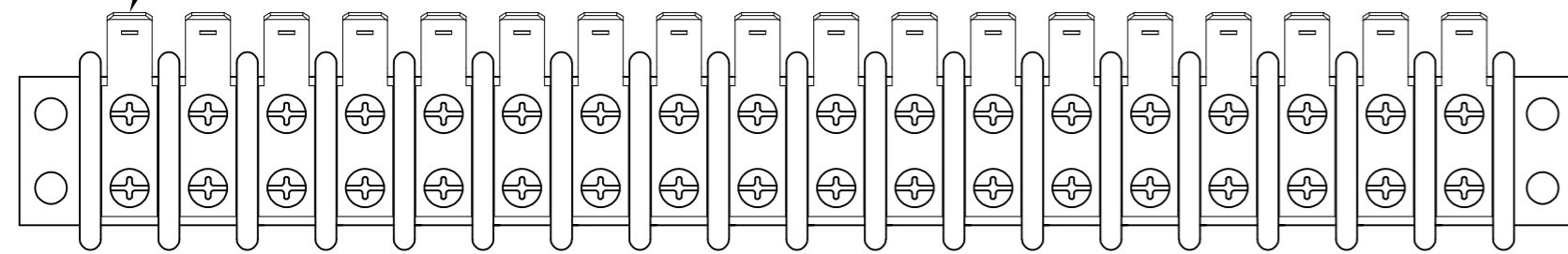

3-1546670-0

DOUBLE SIDED, DOUBLE HOLE
FLAT QC TAB, QTY 8.

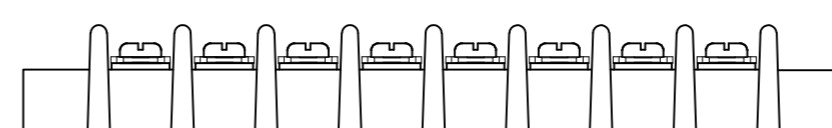
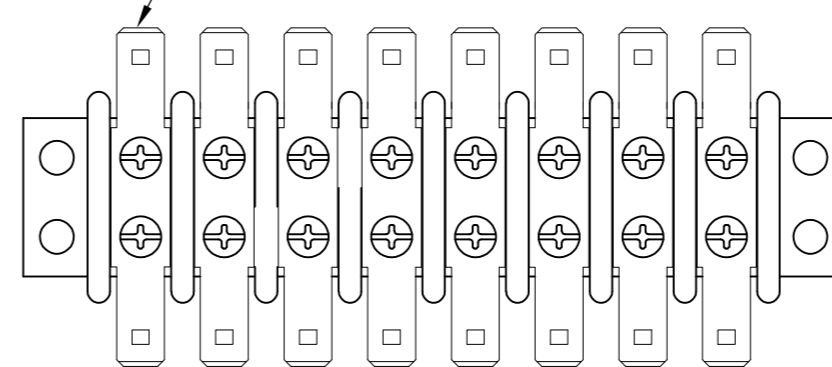

3-1546670-4

DIM B	DIM A	NO OF POS	PART NUMBER
11.764	12.110	26	2-1546670-6
11.327	11.673	25	2-1546670-5
10.90	11.236	24	2-1546670-4
10.453	10.799	23	2-1546670-3
10.016	10.362	22	2-1546670-2
9.579	9.925	21	2-1546670-1
9.142	9.488	20	3-1546670-7

THIS DRAWING IS A CONTROLLED DOCUMENT.		DWN S SCHEGEL	4/4/03	 TE Connectivity	NAME		DOUBLE ROW BARRIER STRIP W/ BINDING HD SCREW, .437 SPACING			
DIMENSIONS: INCHES		CHK C RICHARD	4/4/03		PRODUCT SPEC		SIZE	CAGE CODE	DRAWING NO	RESTRICTED TO
TOLERANCES UNLESS OTHERWISE SPECIFIED: 0 PLC ± - 1 PLC ± - 2 PLC ± .01 3 PLC ± .005 4 PLC ± - ANGLES ± 3°		APVD C RICHARD	4/4/03		APPLICATION SPEC		WEIGHT	A2	00779	C-1546670
MATERIAL		FINISH			CUSTOMER DRAWING		SCALE	NTS	SHEET	2 of 3

THIS DRAWING IS UNPUBLISHED. RELEASED FOR PUBLICATION
 © COPYRIGHT - By - ALL RIGHTS RESERVED.

LOC		DIST		REVISIONS			
P	LTR	DESCRIPTION	DATE	DWN	APVD		
FT	0						
SEE SHEET 1							

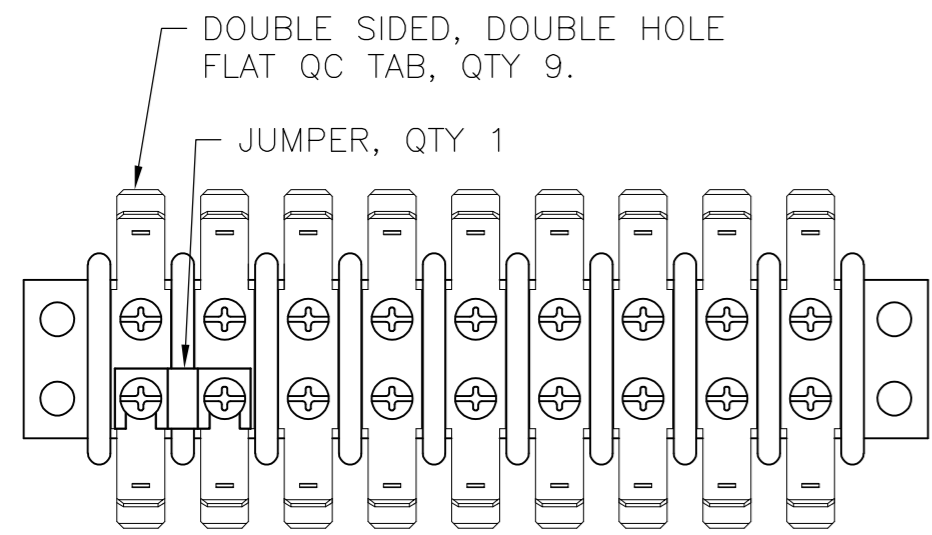

DOUBLE SIDED, DOUBLE HOLE
 FLAT QC TAB, QTY 9.

JUMPER, QTY 1

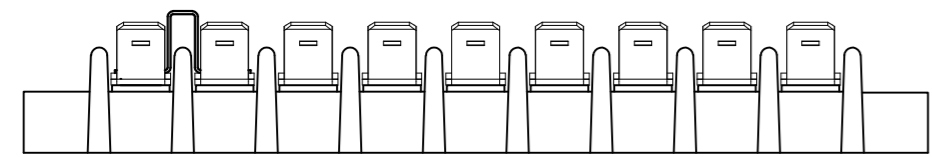

3-1546670-5

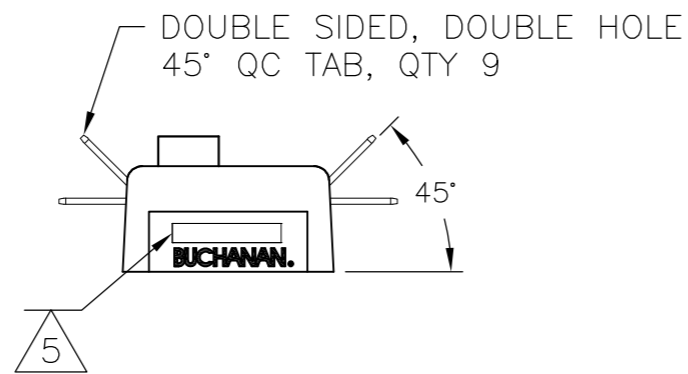

DOUBLE SIDED, DOUBLE HOLE
 45° QC TAB, QTY 9

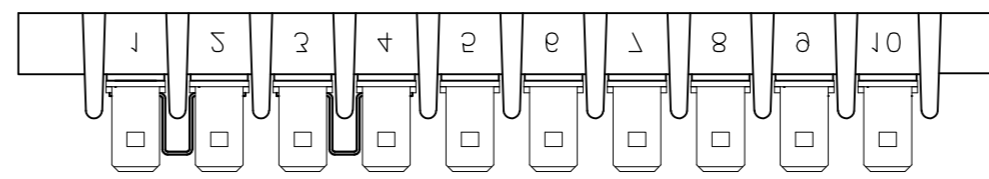

SINGLE SIDED, DOUBLE HOLE
 45° QC TAB, QTY 10

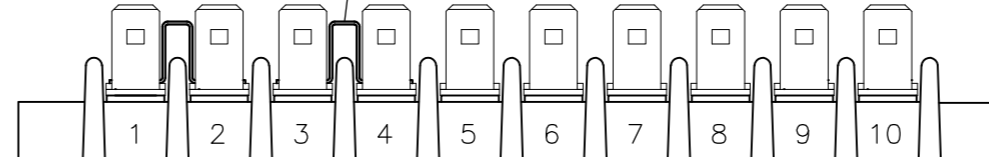

4-1546670-3

SINGLE SIDED, DOUBLE HOLE
 90° QC TAB, QTY 10

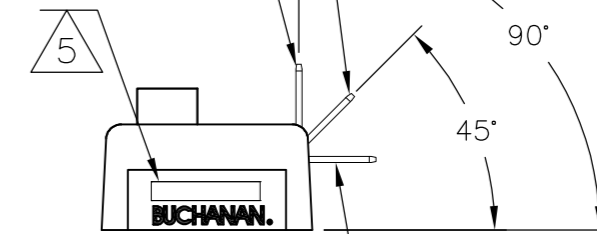

SINGLE SIDED, DOUBLE HOLE
 FLAT QC TAB, QTY 10

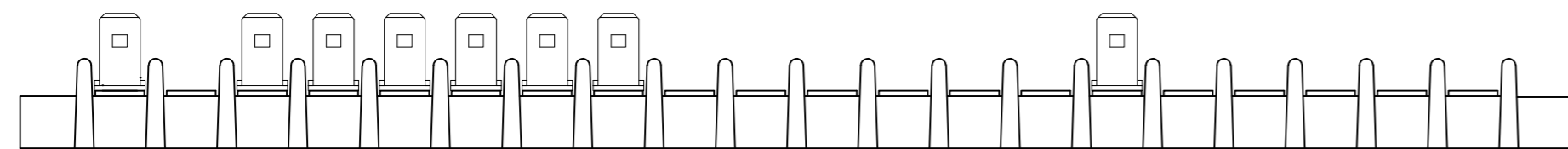

3-1546670-7

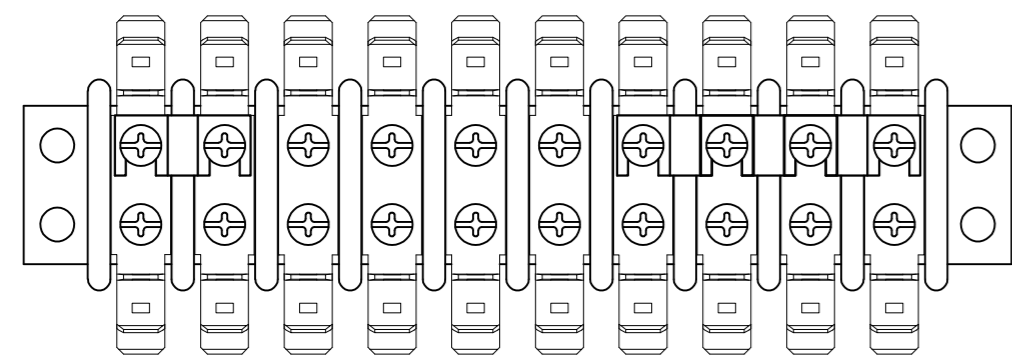
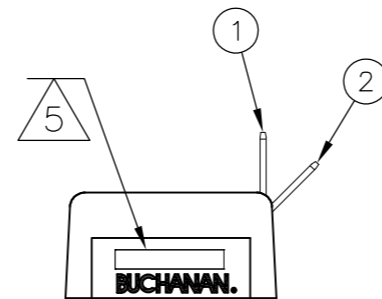

3-1546670-8

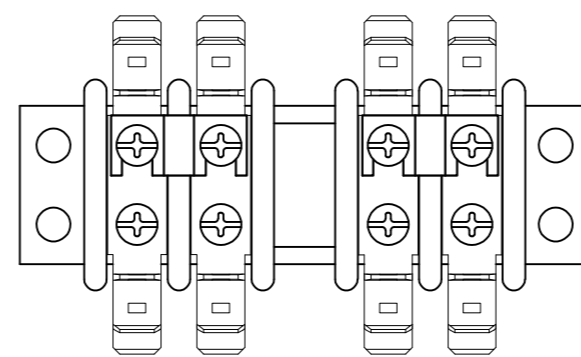
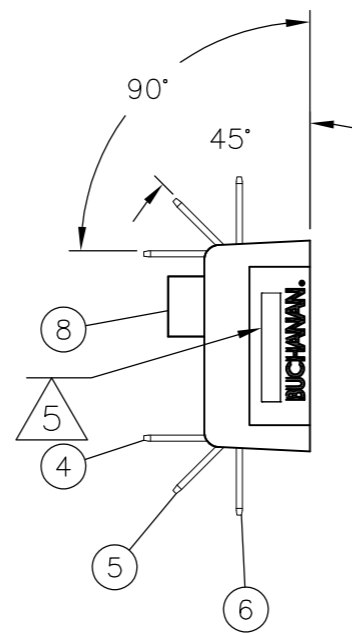

3-1546670-9

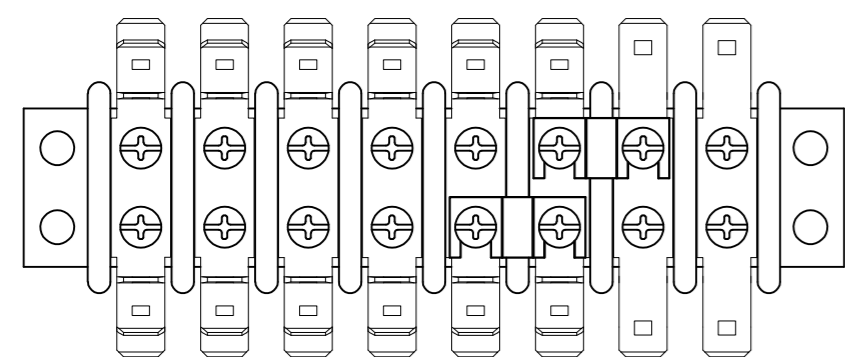
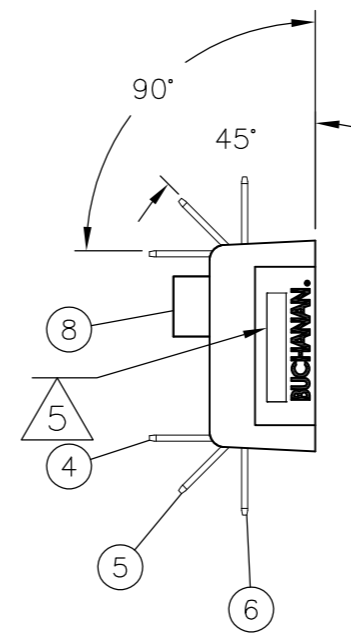

4-1546670-1

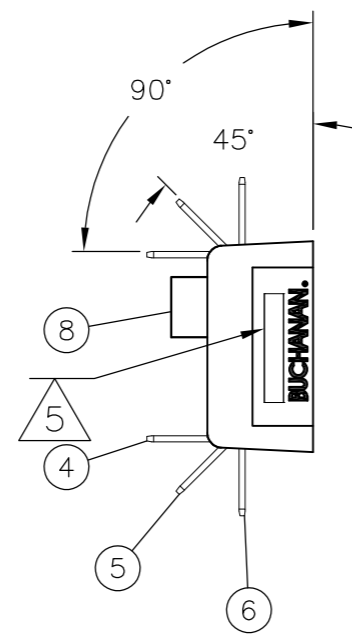

THIS DRAWING IS A CONTROLLED DOCUMENT.		DWN	S SCHEGEL	4/4/03	 TE Connectivity	NAME		DOUBLE ROW BARRIER STRIP W/ BINDING HD		
DIMENSIONS:		CHK	C RICHARD	4/4/03		PRODUCT SPEC		SCREW, .437 SPACING		
INCHES		APVD	C RICHARD	4/4/03		APPLICATION SPEC		SIZE	CAGE CODE	DRAWING NO
		TOLERANCES UNLESS OTHERWISE SPECIFIED:		WEIGHT		A2 00779		C-1546670	RESTRICTED TO	
MATERIAL		FINISH		CUSTOMER DRAWING		SCALE	NTS	SHEET	3 of 3	
0 PLC ± - 1 PLC ± - 2 PLC ± .01 3 PLC ± .005 4 PLC ± - ANGLES ± 3°								REV K18		

X-ON Electronics

Largest Supplier of Electrical and Electronic Components

Click to view similar products for [Barrier Terminal Blocks](#) category:

Click to view products by [TE Connectivity](#) manufacturer:

Other Similar products are found below :

[CR151D20104](#) [670A-RZ-15-KT20](#) [6C1N03](#) [6PCR-02](#) [6PCR-02-008](#) [6PCR-05-008](#) [6PCR-08-008](#) [6PCR-09-008](#) [6PCR-13-006](#) [6PCR-15-006](#) [6PCR-21-006](#) [6PCV-06-008](#) [6PCV-06-716](#) [6PCV-09-001](#) [6PCV-10-009](#) [6PCV-15-008](#) [6PCV-17-1206](#) [6PCV-20-323](#) [6PCV-20-720](#) [6PCV-30-006](#) [6STR-06-006](#) [6STR-08-006](#) [6STR-12-008](#) [6STR-13-006](#) [6STR-14-008](#) [6STR-16-008](#) [6STR-17-008](#) [6STR-21-008](#) [6STR-25-008](#) [6STR-27-008](#) [6STV-03-006](#) [6STV-03-008](#) [6STV-04-006](#) [6STV-09-006](#) [6STV-10-006](#) [6WWR-03-693](#) [6WWV-12-008](#) [72212603](#) [72504-C-50](#) [72506-C](#) [72507-C-50](#) [73203](#) [75505-C](#) [75505-C-50](#) [75510-C](#) [77010-50](#) [7C1N08](#) [812-GP-3/4ST-09](#) [8-1437402-5](#) [8PCR-06-006](#)