

THIS DRAWING IS UNPUBLISHED. RELEASED FOR PUBLICATION 20  
 © COPYRIGHT 20 BY TYCO ELECTRONICS CORPORATION ALL RIGHTS RESERVED.

REVISIONS				
P	LTR	DESCRIPTION	DATE	APVD
E		REVISED PER ECO-14-016912	07NOV2014	DD JS
E1		REVISED PER ECO-16-002322	18FEB2016	DD JS

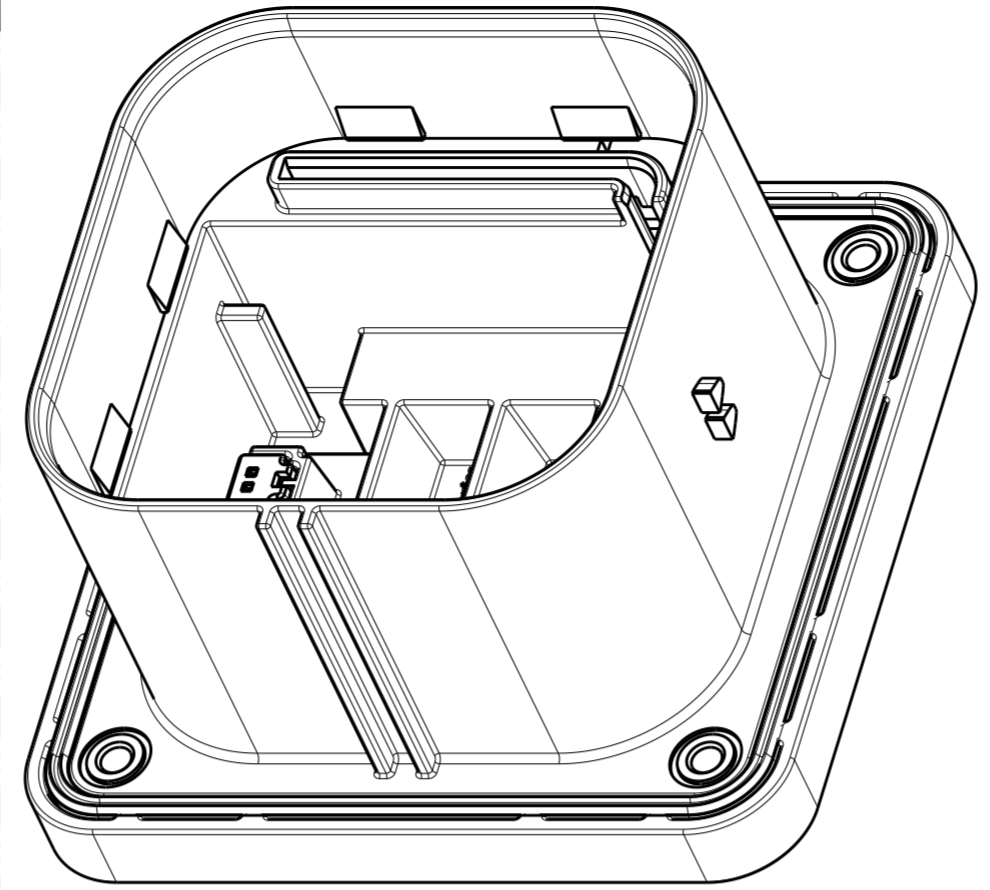

ISOMETRIC VIEW  
SCALE 1:1

- 1 M6-1 THREADED STUD  
TORQUE LIMITS: 10Nm±0.5Nm
- 2 M6-1 THREADED INSERT  
TORQUE LIMITS: 9Nm - 11Nm  
THREADED BUSHINGS (4X) HEAT STAKED FLUSH TO MAX 0.40mm DEEP FROM THIS SURFACE.
- 3 HVIL CONNECTOR RETAINING LOCATIONS  
HVIL CONNECTOR:  
1534112-1 (RETAINER; MQS; 2P)  
1-1534113-1 (RECEPTACLE HOUSING; MQS; 2P)  
HVIL CONTACT:  
928999-6 (SOCKET CONTACT; MQS; Ag)
- 4 MOUNTING SURFACE THICKNESS (MAX): 6.2mm
- 5 SURFACE FINISH AND FLATNESS APPLY WITHIN BOUNDARY SHOWN.
- 6. INNER HOUSING MAY BE ASSEMBLED ROTATED 180° FROM AS SHOWN.
- 7 ASSEMBLY / WORK INSTRUCTIONS: 408-10377
- 8 NOTE DELETED
- 9 SEE SHEET 2 FOR FUSE RATING MARKINGS AND KEYING CONFIGURATIONS.
- 10 SURFACE FINISH IN MICRONS (µm)

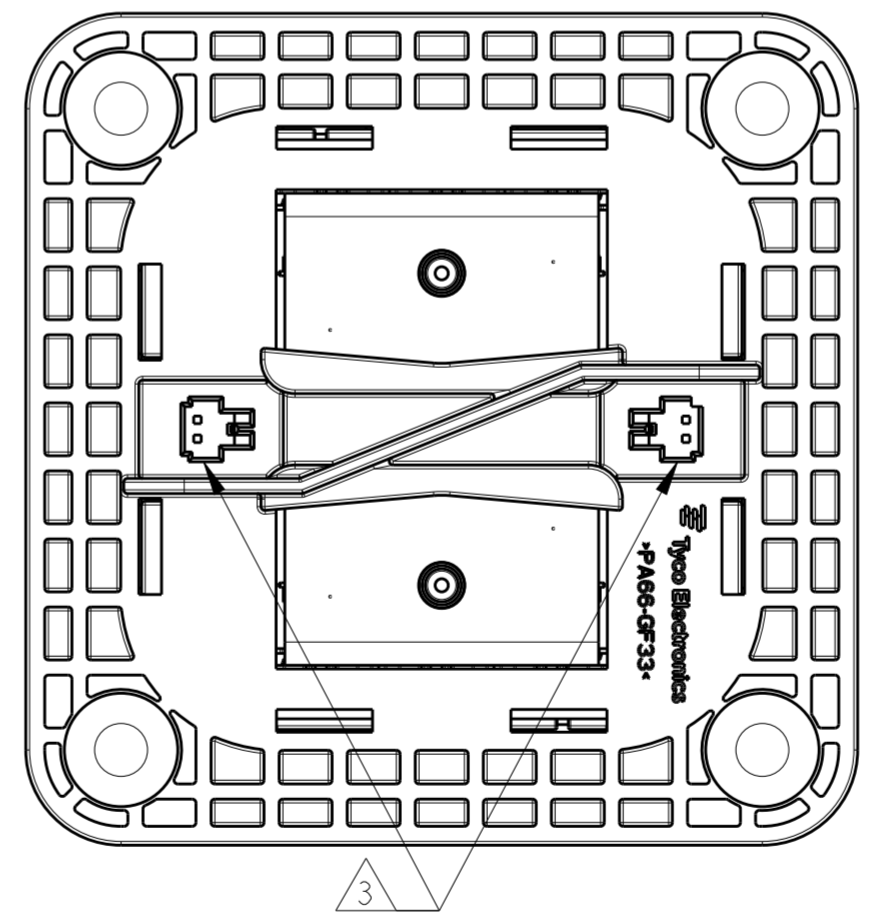
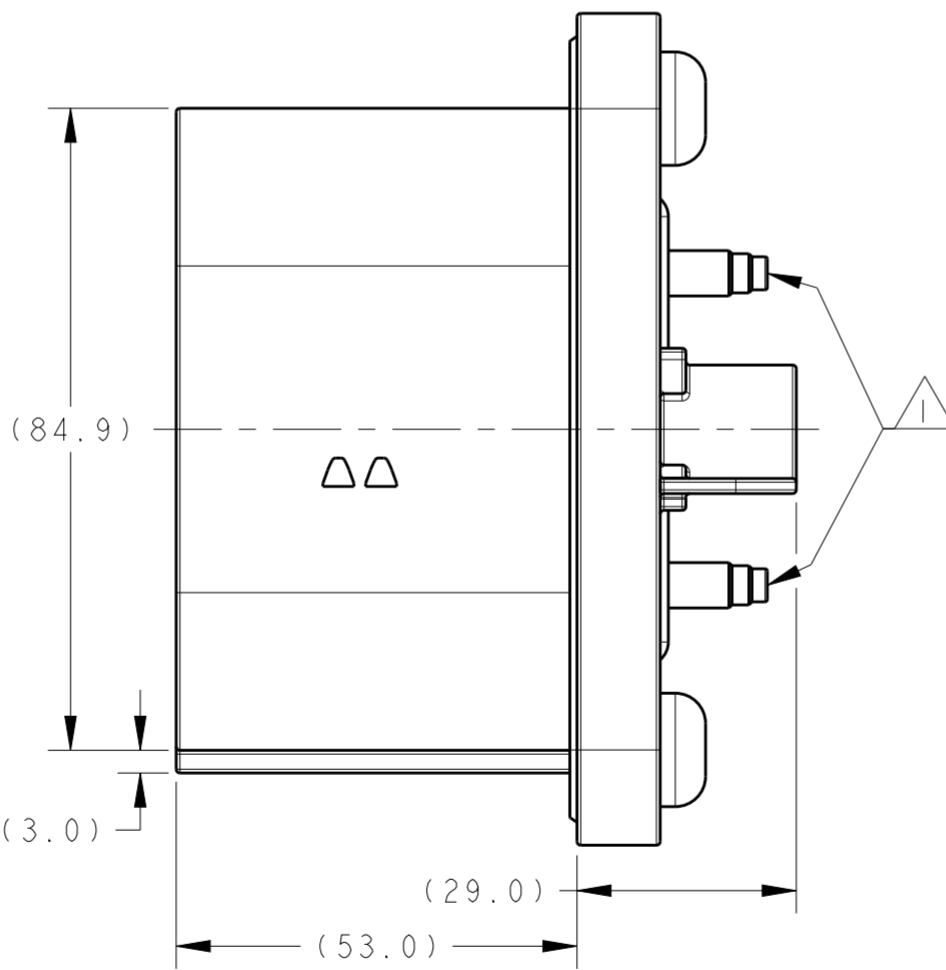
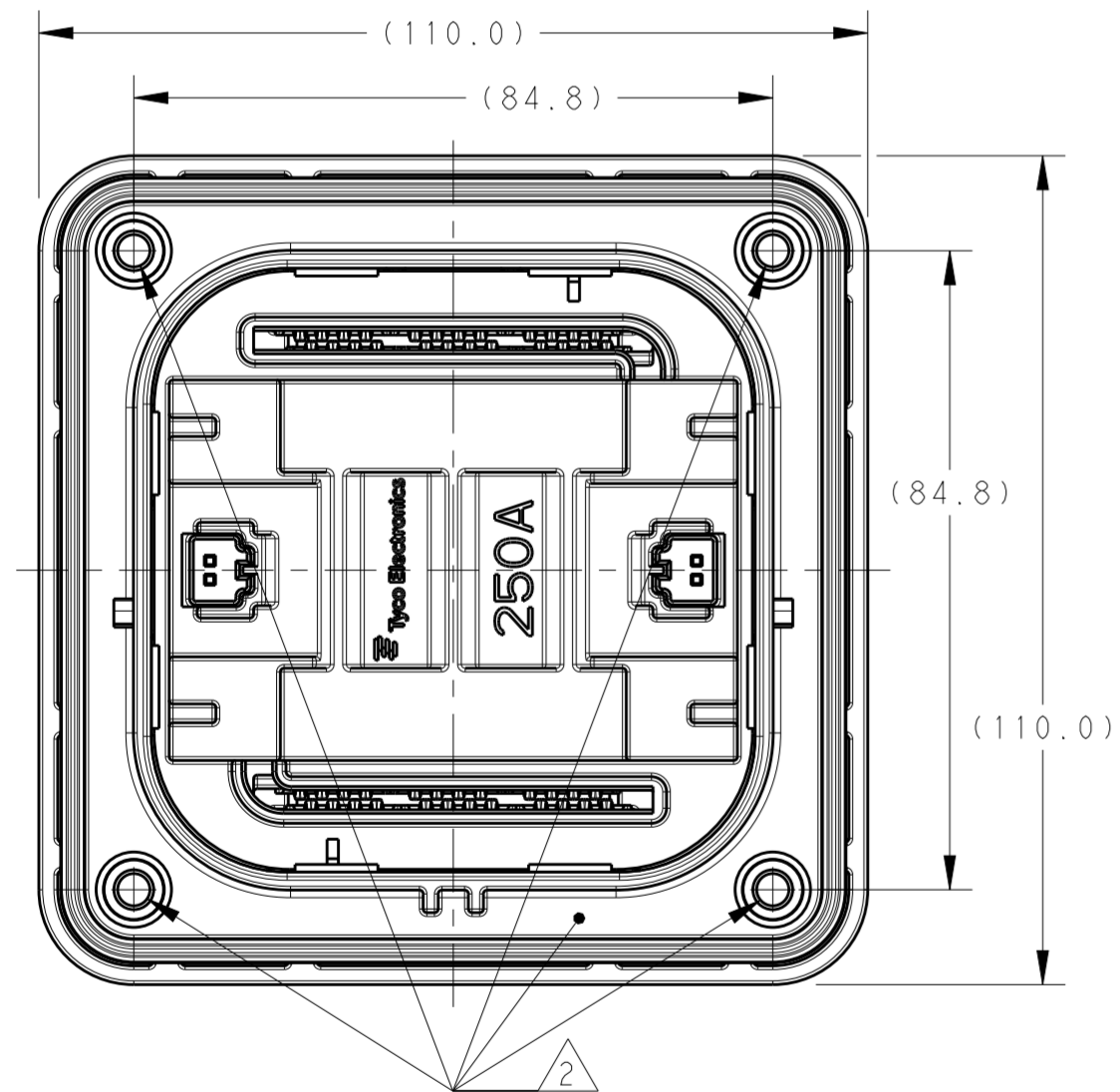

DESCRIPTION	PART NUMBER
M6 THREADED INSERT	1-1587987-7
E1 M6 THREADED INSERT (350A WITH DIVIDER NOTCH)	1-1587987-5
M6 THREADED INSERT	1-1587987-4
E1 M6 THREADED INSERT (250A WITH DIVIDER NOTCH)	1-1587987-3
M6 THREADED INSERT	1-1587987-1
M6 THREADED INSERT	1587987-9
M6 THREADED INSERT	1587987-8

THIS DRAWING IS A CONTROLLED DOCUMENT. DIMENSIONING AND TOLERANCING PER ASME Y14.5M-2009

DWN: G. COITIER 10MAR2010  
 CHK: A. BOYER 10MAR2010  
 APVD: J. BOLEWITZ 10MAR2010

PRODUCT SPEC: 108-127000  
 APPLICATION SPEC: -

MATERIAL: -  
 DIMENSIONS: mm  
 TOLERANCES UNLESS OTHERWISE SPECIFIED:  
 0 PLC ±  
 1 PLC ±  
 2 PLC ±  
 3 PLC ±  
 4 PLC ±  
 ANGLES ±  
 FINISH -

WEIGHT: 320.34g  
 CUSTOMER DRAWING

SCALE: 1:1  
 SHEET: 1 OF 3  
 REV: E1

TE Connectivity  
 RECEPTACLE ASSEMBLY  
 MANUAL SERVICE DISCONNECT

SIZE: A2  
 CAGE CODE: 00779  
 DRAWING NO: C-1587987

THIS DRAWING IS UNPUBLISHED.  
 RELEASED FOR PUBLICATION  
 20  
 © COPYRIGHT 20 BY TYCO ELECTRONICS CORPORATION ALL RIGHTS RESERVED.

REVISIONS				
P	LTR	DESCRIPTION	DATE	APVD
-	-	SEE SHEET 1	-	-

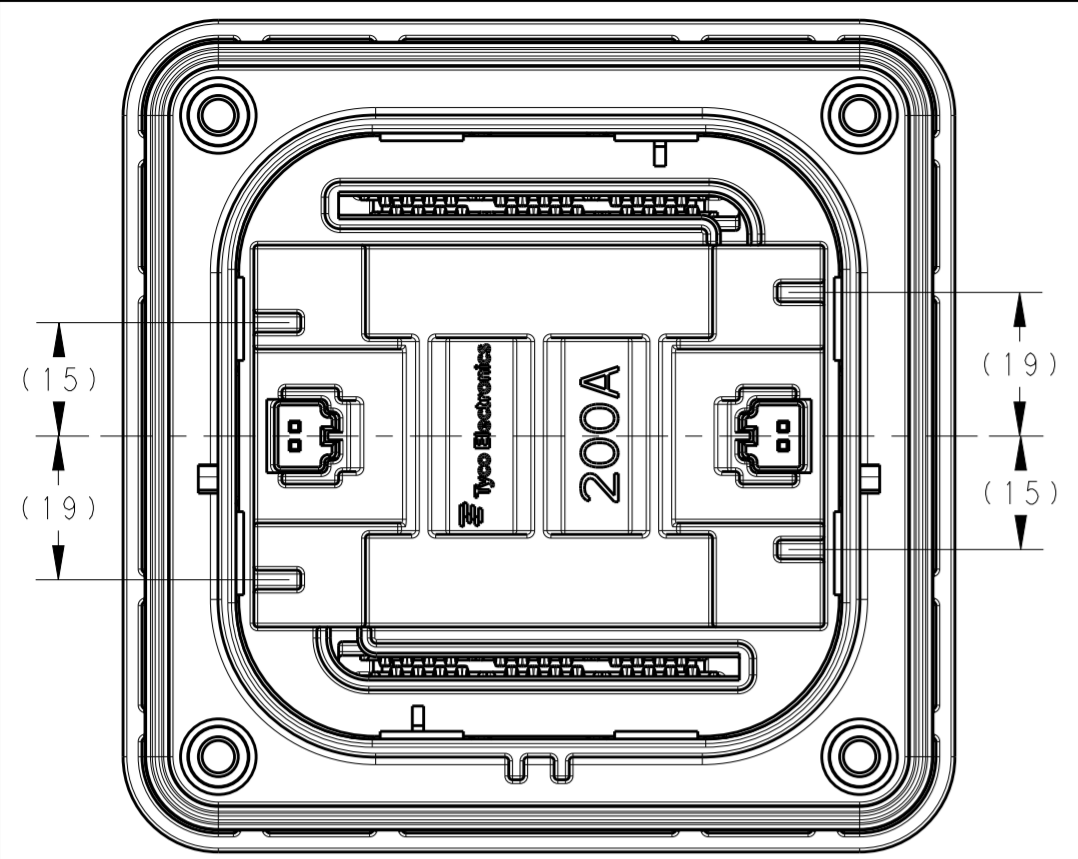

**1587987-8**  
 FUSE RATING: 200A

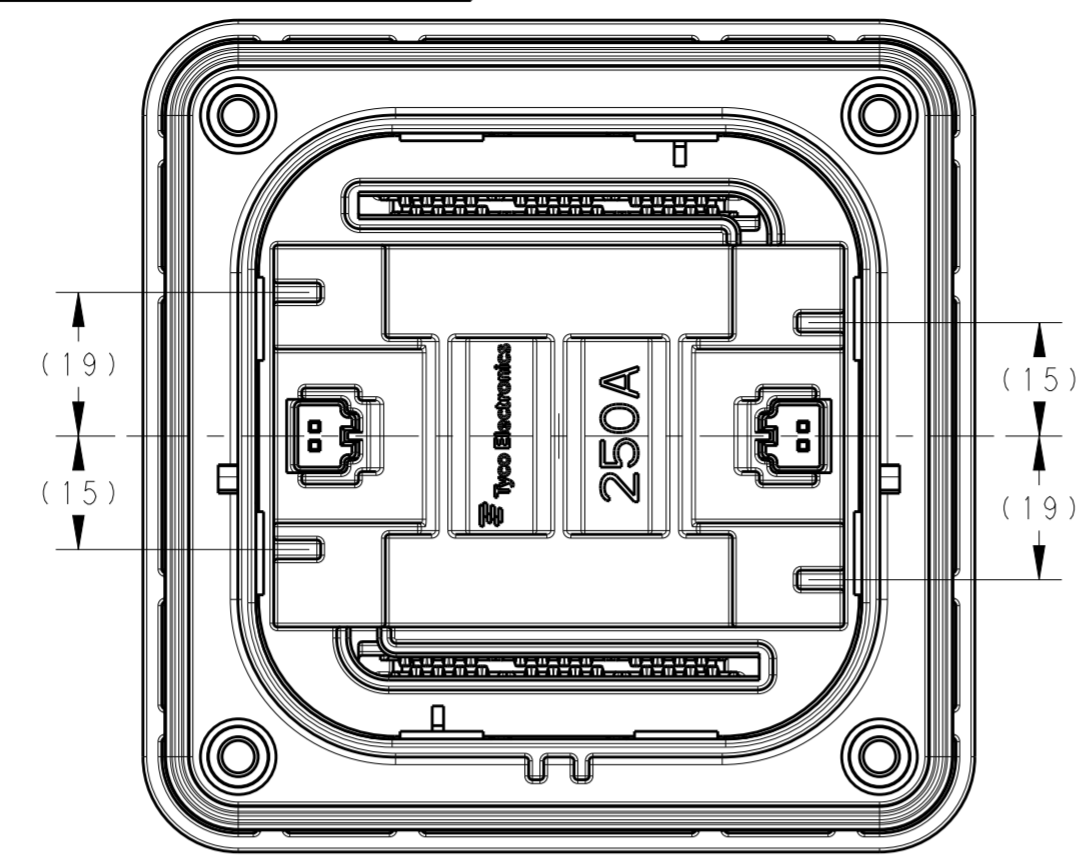

**1587987-9**  
 FUSE RATING: 250A

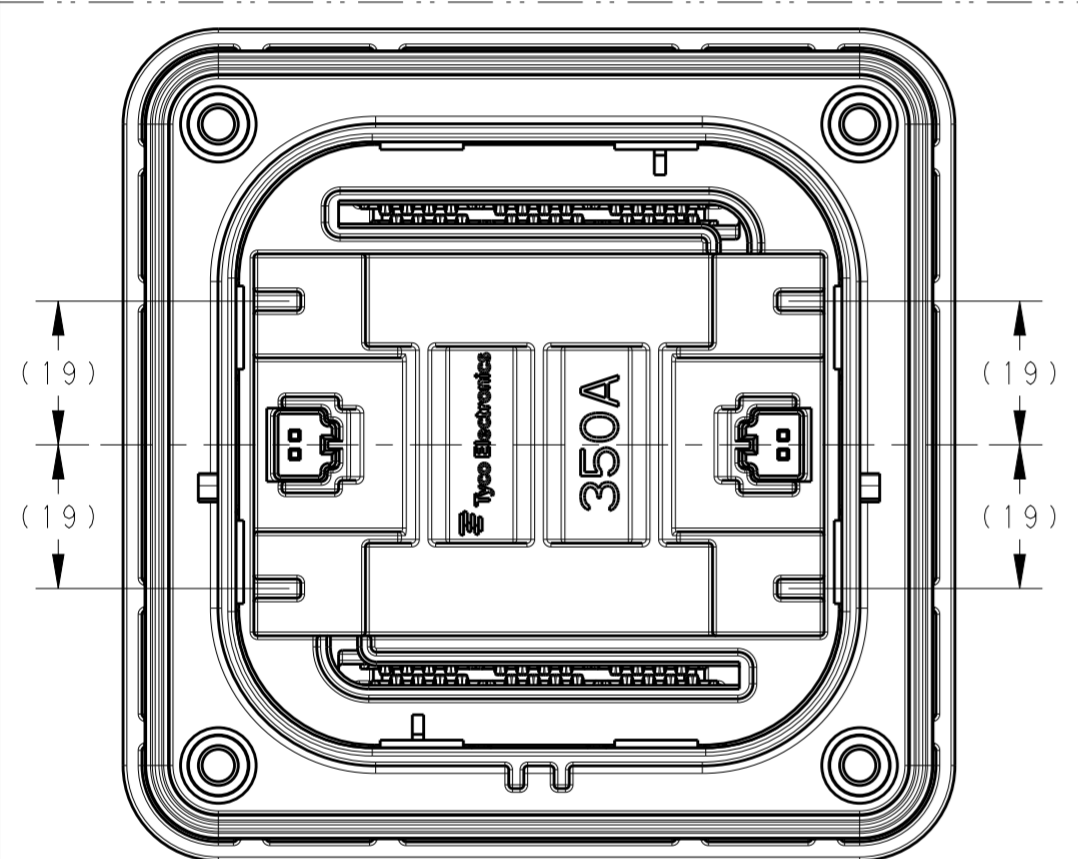

**1-1587987-1**  
 FUSE RATING: 350A

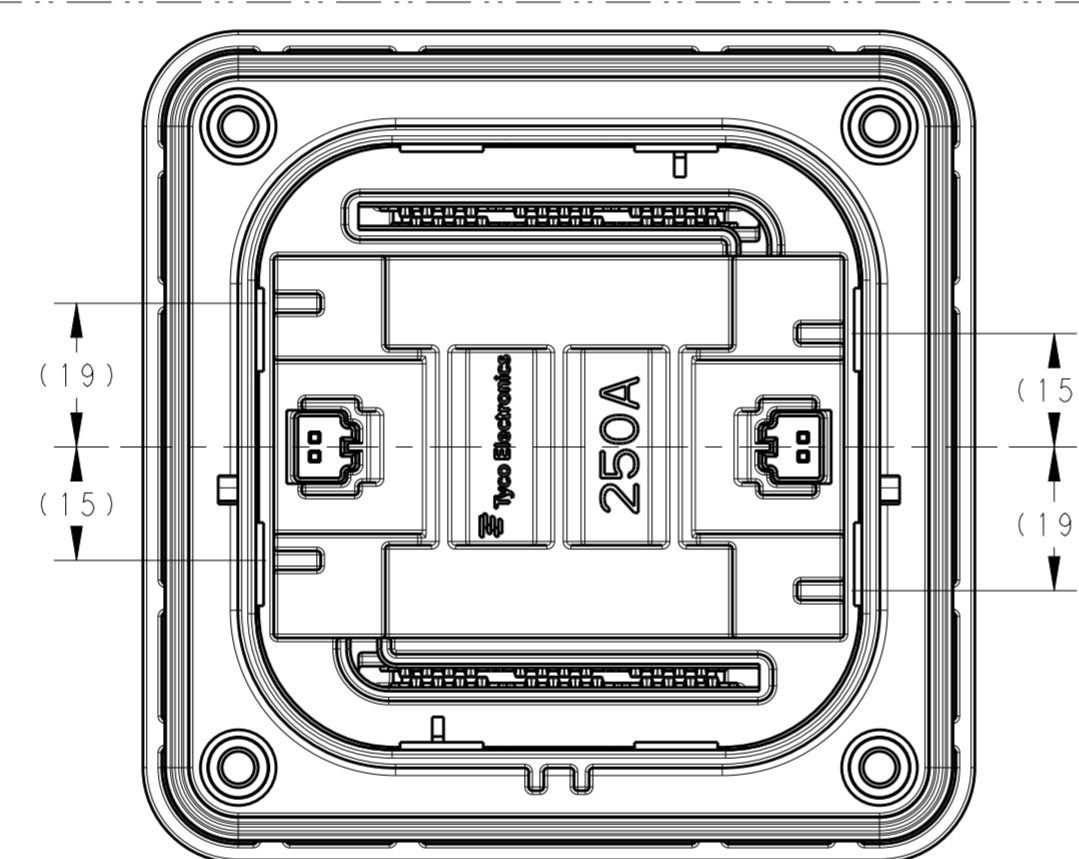

**1-1587987-3**  
 (WITH DIVIDER RIB NOTCH)  
 FUSE RATING: 250A

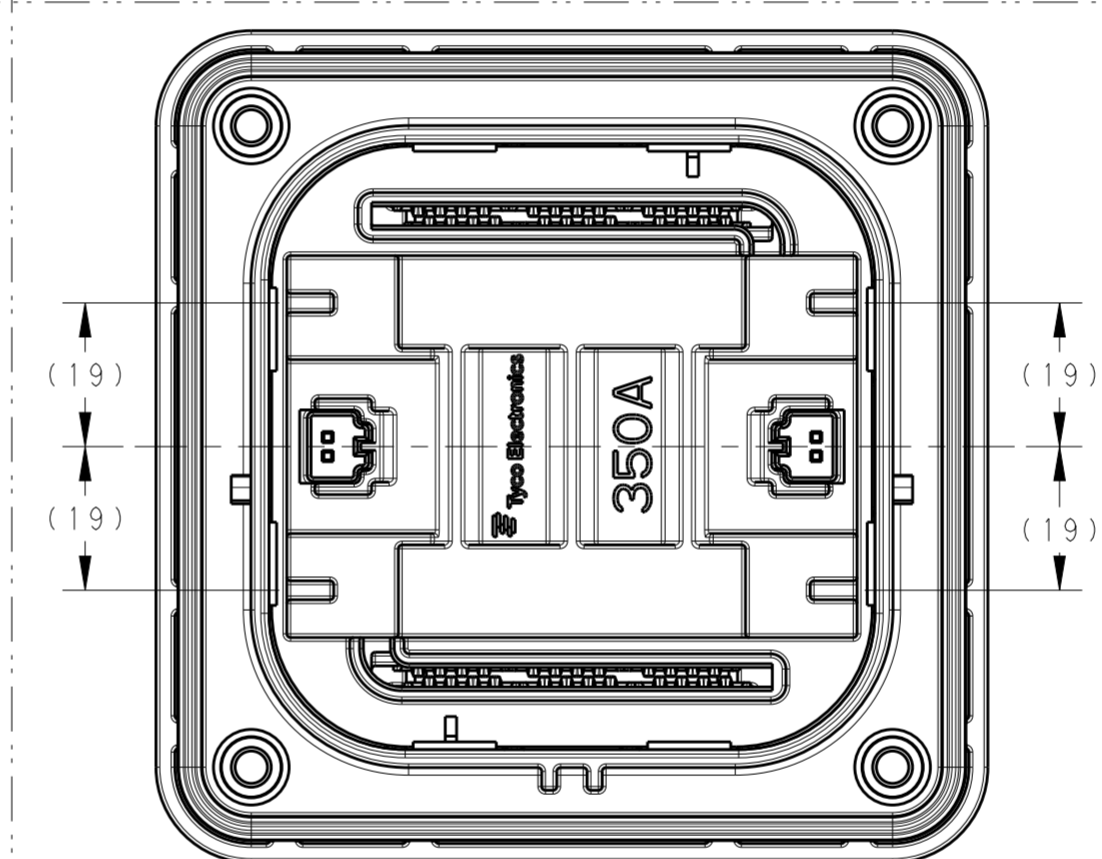

**1-1587987-5**  
 (WITH DIVIDER RIB NOTCH) **E1**  
 FUSE RATING: 350A

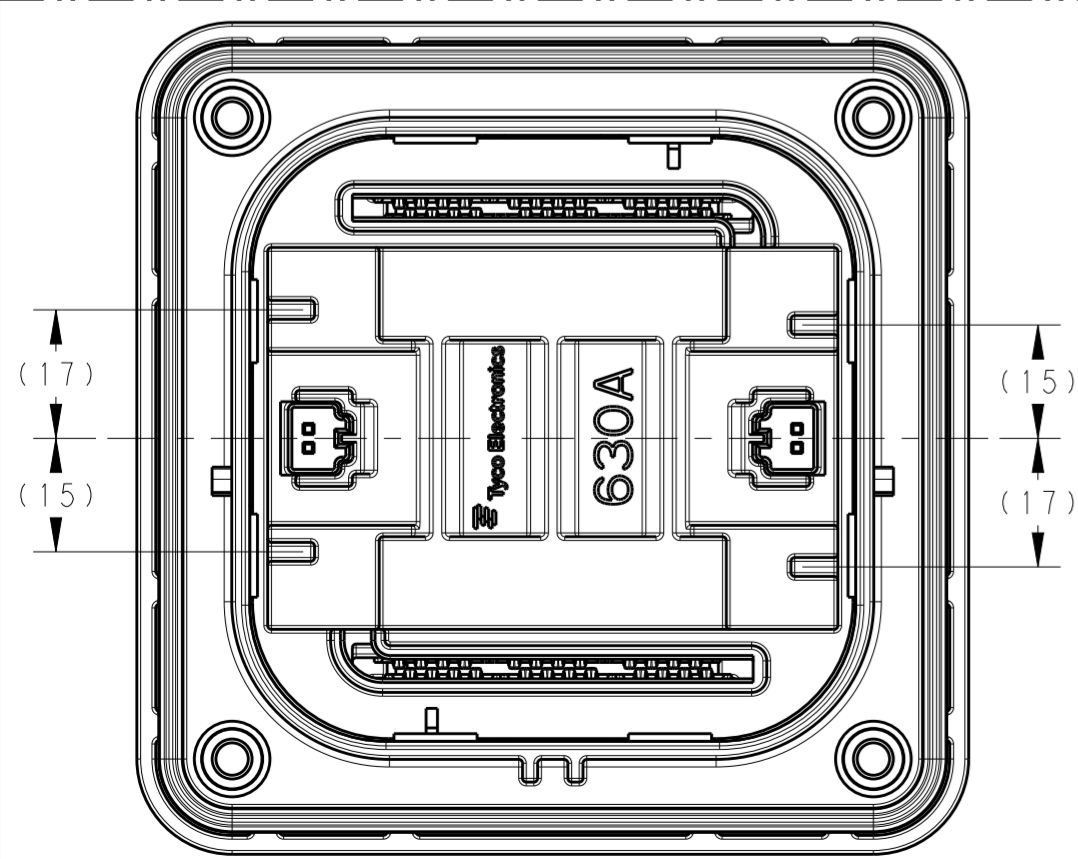

**1-1587987-4**  
 FUSE RATING: 630A

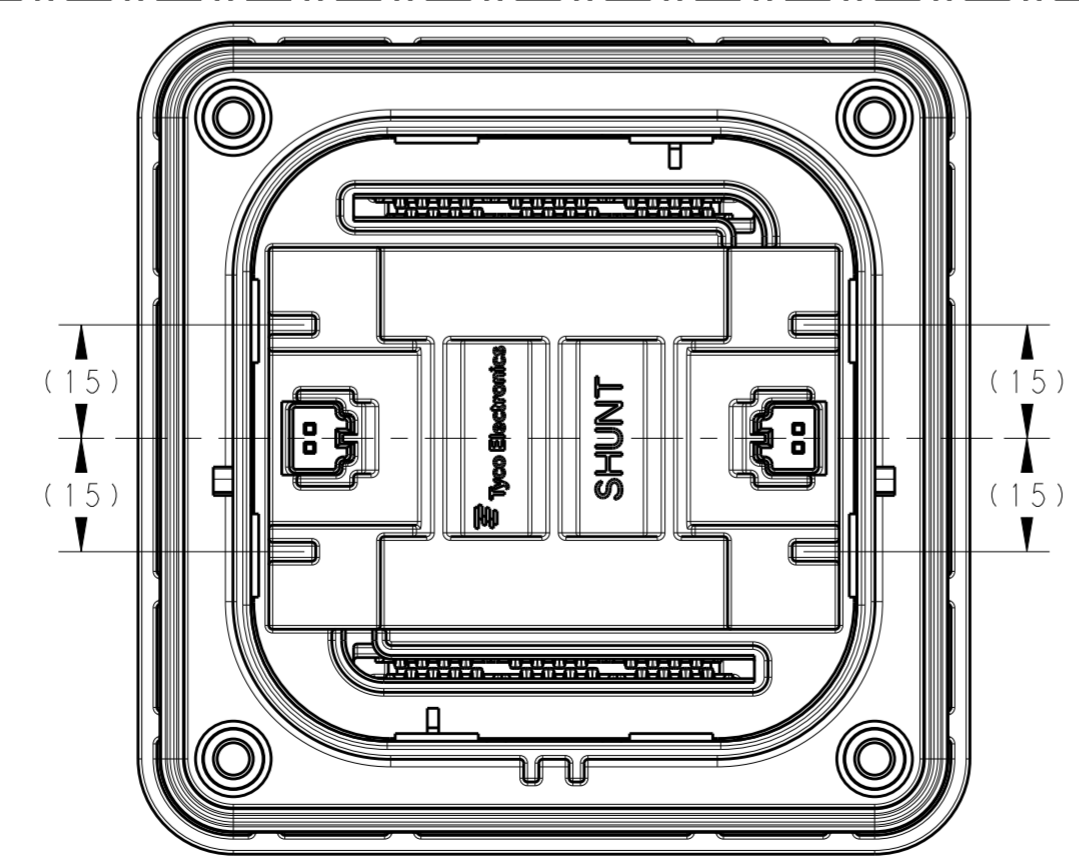

**1-1587987-7**  
 SHUNT

THIS DRAWING IS A CONTROLLED DOCUMENT. DIMENSIONING AND TOLERANCING PER ASME Y14.5M-2009		DWN G. COITIER 10MAR2010	 TE Connectivity	NAME		
DIMENSIONS: mm		CHK A. BOYER 10MAR2010		RECEPTACLE ASSEMBLY MANUAL SERVICE DISCONNECT		
TOLERANCES UNLESS OTHERWISE SPECIFIED:		APVD J. BOLEWITZ 10MAR2010		SIZE	CAGE CODE	DRAWING NO
0 PLC ± 1 PLC ± 2 PLC ± 3 PLC ± 4 PLC ± ANGLES ± FINISH -		PRODUCT SPEC 108-127000		RESTRICTED TO	-	
MATERIAL -		APPLICATION SPEC -	WEIGHT 320.34g	A200779	C-1587987	
-		CUSTOMER DRAWING	SCALE 1:1	SHEET 2 OF 3	REV E1	

THIS DRAWING IS UNPUBLISHED. RELEASED FOR PUBLICATION 20  
 © COPYRIGHT 20 BY TYCO ELECTRONICS CORPORATION ALL RIGHTS RESERVED.

REVISIONS				
P	LTR	DESCRIPTION	DATE	APVD
-	-	SEE SHEET 1	-	-

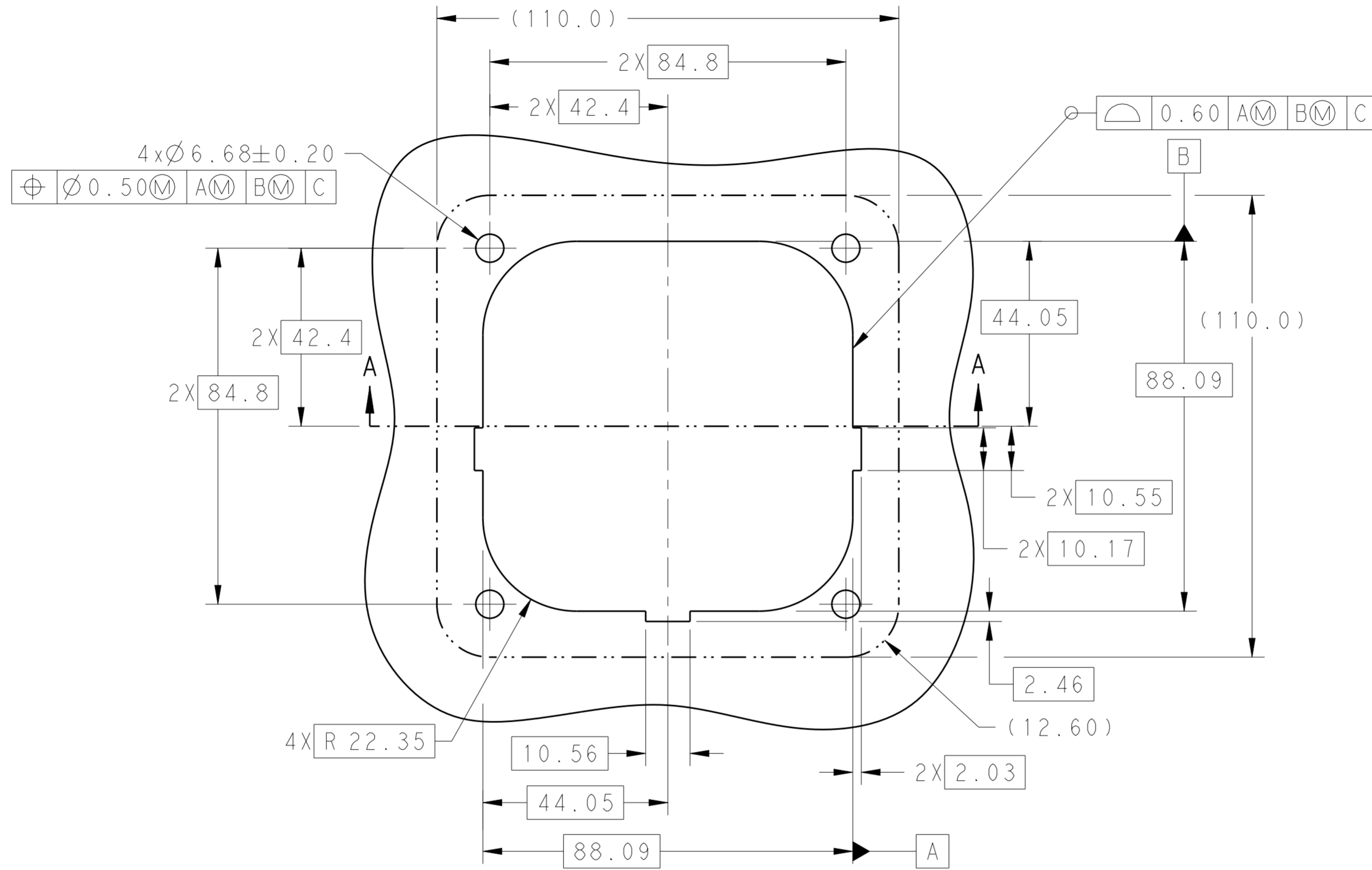

**MOUNTING INTERFACE SPECIFICATION**

THIS DRAWING IS A CONTROLLED DOCUMENT. DIMENSIONING AND TOLERANCING PER ASME Y14.5M-2009		DWN: G. COITER 10MAR2010 CHK: A. BOYER 10MAR2010 APVD: J. BOLEWITZ 10MAR2010	<b>STE</b> TE Connectivity	
DIMENSIONS: mm		PRODUCT SPEC: 108-127000	NAME: RECEPTACLE ASSEMBLY MANUAL SERVICE DISCONNECT	
TOLERANCES UNLESS OTHERWISE SPECIFIED: 0 PLC ± 1 PLC ± 2 PLC ± 3 PLC ± 4 PLC ± ANGLES ± FINISH		APPLICATION SPEC: 7	SIZE: A2	CAGE CODE: 00779
MATERIAL: -		WEIGHT: 320.34g	DRAWING NO: C-1587987	RESTRICTED TO: -
CUSTOMER DRAWING		SCALE: 1:1	SHEET: 3 OF 3	REV: E1

## X-ON Electronics

Largest Supplier of Electrical and Electronic Components

*Click to view similar products for [Automotive Connectors](#) category:*

*Click to view products by [TE Connectivity](#) manufacturer:*

Other Similar products are found below :

[003-018-000](#) [60403001](#) [60993906-B](#) [M902-2131](#) [M902-2161](#) [M902-2344](#) [72.330.1035.1](#) [73.353.4028.0](#) [F119300-B](#) [F166900](#) [F258300-B](#)  
[F358300-B](#) [F407400](#) [F444110](#) [F487000](#) [F509500B-B](#) [827153-1](#) [8N1515-32-24P](#) [9-1326729-8](#) [925474-1](#) [928905-1](#) [964562-4](#) [968782-1](#)  
[GT17SA-8DS-HU](#) [98891-1012](#) [98947-1016](#) [12004147](#) [12004475-L](#) [12010290](#) [12010309-B](#) [12015454](#) [12020219-B](#) [12041318-B](#) [12052225-](#)  
[L](#) [12052466](#) [12064869](#) [12004327-B](#) [12015308](#) [12015384](#) [12015909](#) [1-21030-1](#) [12041254](#) [12041318](#) [12047946-B](#) [12047957](#) [12047957-L](#)  
[12059473](#) [12066261](#) [12110546](#) [12110546-B](#)