

REVISIONS				
P	LTR	DESCRIPTION	DATE	APVD
-	-	SEE SHEET 1	-	-

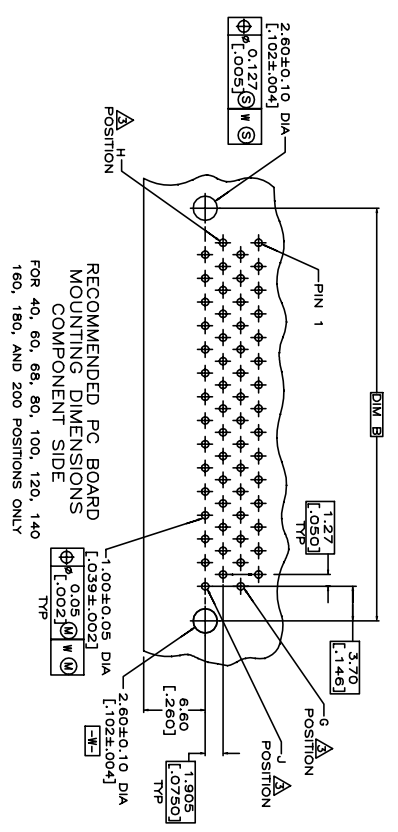

RECOMMENDED PC BOARD MOUNTING DIMENSIONS COMPONENT SIDE FOR 40, 60, 68, 80, 100, 120, 140, 160, 180, AND 200 POSITIONS ONLY

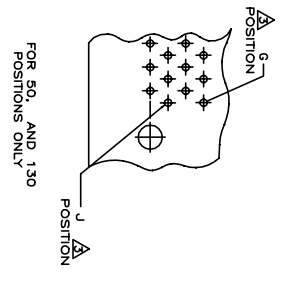

FOR 50, AND 130 POSITIONS ONLY

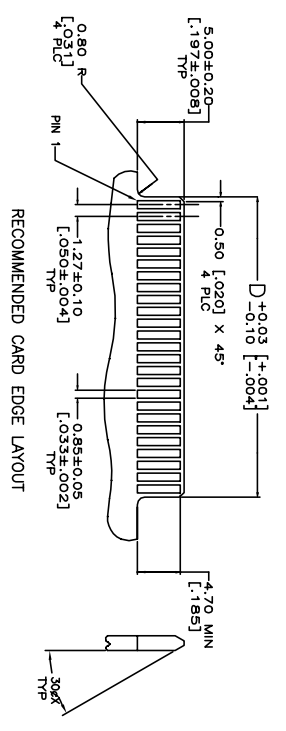

RECOMMENDED CARD EDGE LAYOUT

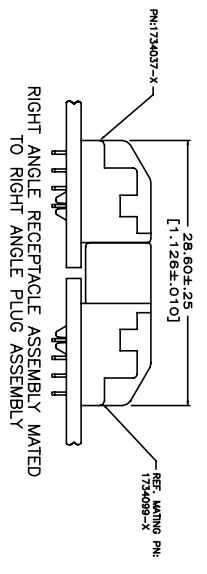

RIGHT ANGLE RECEPTACLE ASSEMBLY MATED TO RIGHT ANGLE PLUG ASSEMBLY

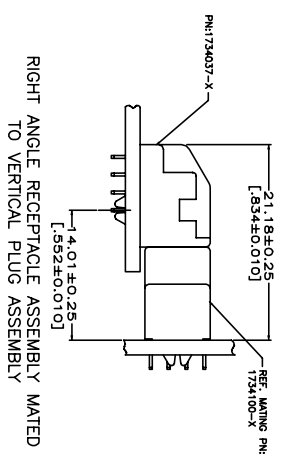

RIGHT ANGLE RECEPTACLE ASSEMBLY MATED TO VERTICAL PLUG ASSEMBLY

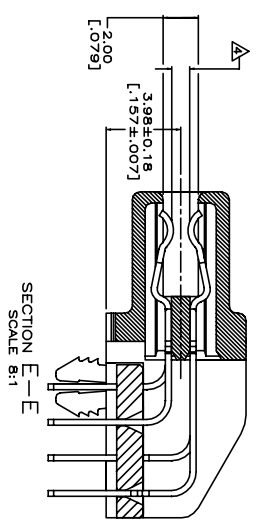

SECTION E-E SCALE 8:1

THIS DRAWING IS A CONTROLLED DOCUMENT.

DIMENSIONS:	mm	TOLERANCES UNLESS OTHERWISE SPECIFIED:	0 P/C ±	1 P/C ±	2 P/C ±	3 P/C ±	4 P/C ANGLES ±
MATERIAL:		FINISH:					

APVD: [Signature] DATE: [Blank] DWG: [Blank] CHK: [Blank]

PRODUCT SPEC: [Blank] APPLICATION SPEC: [Blank] WEIGHT: [Blank]

CUSTOMER DRAWING: [Blank]

NAME: **STE** TE Connectivity Ltd.

RECEPTACLE ASSEMBLY, R/A, BTB, CHAMP.050, SERIES I

SIZE: A3 CAGE CODE: 00779 DRAWING NO: 1734037 RESTRICTED 70

SCALE: [Blank] SHEET: 2 OF 4 REV: G2

REVISIONS				
P	LTR	DESCRIPTION	DATE	APVD
-	-	SEE SHEET 1	-	-

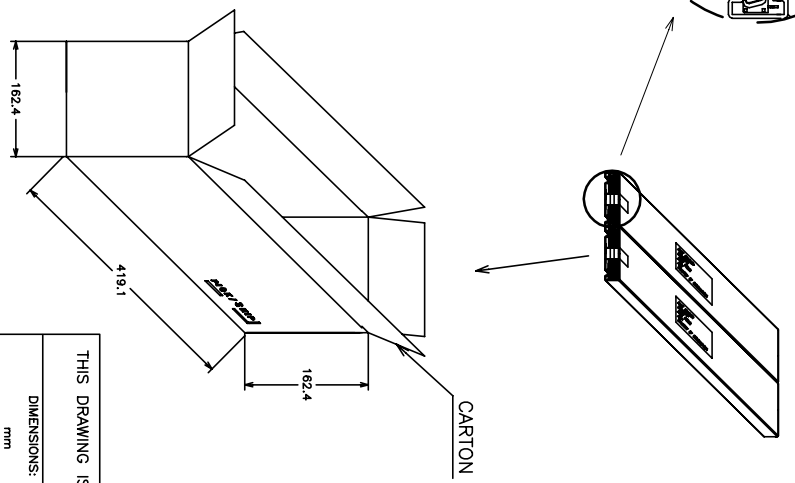
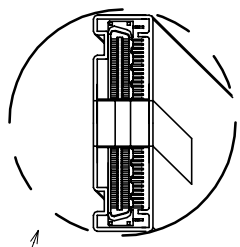
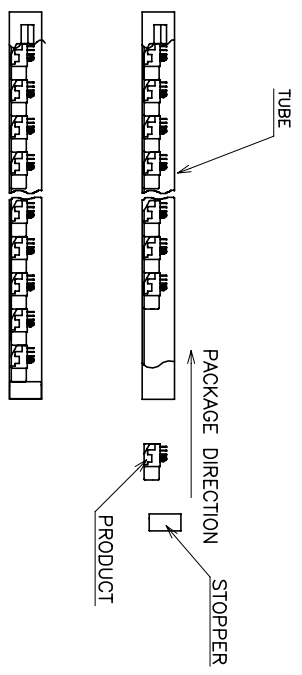

POS.	QTY/ TUBE	TUBE/ BOX	QTY/ BOX	N/W (KG)	G/W (KG)	PART NUMBER
						6-1734037-2
						4-1734037-2
						2-1734037-2
						1734037-2
						5-1734037-0
						3-1734037-0
						1-1734037-0
						4-1734037-1
						2-1734037-1
						1734037-1

Ⓢ OBSOLETE

THIS DRAWING IS A CONTROLLED DOCUMENT.

DIMENSIONS: mm

TOLERANCES UNLESS OTHERWISE SPECIFIED:	FINISH
0 P/C	±
1 P/C	±
2 P/C	±
3 P/C	±
4 P/C	±
ANGLES	±

DWG	CHK	APVD	PRODUCT SPEC	APPLICATION SPEC	WEIGHT	CUSTOMER DRAWING
-	-	-	-	-	-	-

STPTE TE Connectivity Ltd.

RECEPTACLE ASSEMBLY, R/A,
BTB, CHAMP.050, SERIES I

SIZE A3
CAGE CODE 00779
DRAWING NO. 1734037

RESTRICTED 70
SCALE - SHEET 3 OF 4 REV G2

REVISIONS				
P	LTR	DESCRIPTION	DATE	APVD
-	-	SEE SHEET 1	-	-

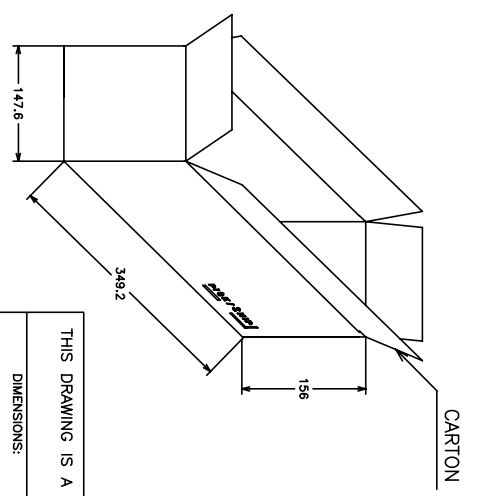
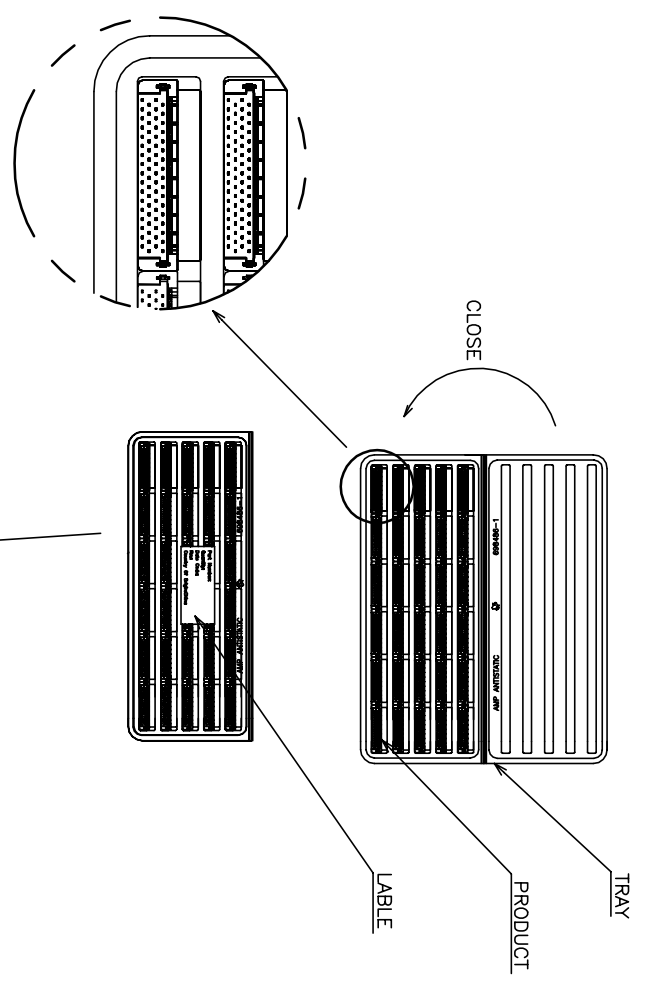

QTY/ TRAY	TRAY/ BOX	QTY/ BOX	N/W (KG)	G/W (KG)	PART NUMBER	
40	45	10	450	1.55	2.45	5-1734037-4
160	10	10	100	1.33	2.28	5-1734037-6
						3-1734037-6
						1-1734037-6
						5-1734037-4
						3-1734037-4
						1-1734037-4
						2-1734037-0
						1-1734037-8
						1-1734037-2
						5-1734037-1
						3-1734037-1
						1-1734037-1
						4-1734037-7
						2-1734037-7
						1734037-7
						4-1734037-6
						2-1734037-6
						1734037-6
						4-1734037-5
						2-1734037-5
						1734037-5
						4-1734037-4
						2-1734037-4
						1734037-4
						4-1734037-3
						2-1734037-3
						1734037-3
						4-1734037-2
						2-1734037-2
						1734037-2
						4-1734037-1
						2-1734037-1
						1734037-1
						4-1734037-0
						2-1734037-0
						1734037-0
						4-1734037-0
						2-1734037-0
						1734037-0

THIS DRAWING IS A CONTROLLED DOCUMENT.

DIMENSIONS:	TOLERANCES UNLESS OTHERWISE SPECIFIED:	DMN	CHK	APVD	NAME
mm					RECEPTACLE ASSEMBLY, R/A, BTB, CHAMP.050, SERIES I
0 P/C	±				
1 P/C	±				
2 P/C	±				
3 P/C	±				
4 P/C	±				
ANGLES	±				
FINISH					
MATERIAL					

APVD: [Signature]

PRODUCT SPEC: [Blank]

APPLICATION SPEC: [Blank]

WEIGHT: [Blank]

CUSTOMER DRAWING: [Blank]

SIZE: A3

DATE CODE: 00779

DRAWING NO: 1734037

RESTRICTED TO: [Blank]

SCALE: [Blank]

SHEET: 4 of 4

REV: G2

X-ON Electronics

Largest Supplier of Electrical and Electronic Components

Click to view similar products for [Board to Board & Mezzanine Connectors](#) category:

Click to view products by [TE Connectivity](#) manufacturer:

Other Similar products are found below :

[589158040000018](#) [MDF7C-18P-2.54DSA\(55\)](#) [FCN-230C068-11](#) [FCN-268F012-G/BD](#) [FCN-268F036-G/BD](#) [FCN-268M012-G/0D](#) [FCN-268M024-G/1D](#) [FCN-723J004/1](#) [MIS-048-01-F-D-DP-K](#) [832-10-034-10-001000](#) [FX4C-80S-1.27DSA](#) [FCN-214Q030-G/0](#) [FCN-234P048-G/0](#) [FCN-235D050-G/C](#) [210-93-314-41-105000](#) [2-22603-0](#) [MDF7-40DP-2.54DSA\(55\)](#) [AXG720047](#) [5031084030](#) [MIT-114-03-F-D-K](#) [55323-1519](#) [DF33-2P-3.3DSA\(24\)](#) [YFT-20-05-H-03-SB-K](#) [503308-3040](#) [026-6203-PDB](#) [027-6203-PDB](#) [069159702701000](#) [10123981-102LF](#) [101A10019X](#) [55650-0588-C](#) [68682-310LF](#) [68684-306](#) [75140-7012](#) [87471-650](#) [194261-1](#) [FCN-268F024-G0D](#) [10124054-515LF](#) [68685-603](#) [8-1616154-3](#) [MIS-019-01-F-D](#) [FCN-268M024-G/3D](#) [20021832-06016C1LF](#) [KX15-20KLDL-E1000E](#) [MDF7-16DP-2.54DSA\(55\)](#) [AXE810124](#) [FCN-214J100-G/0](#) [FCN-230C068-E/S](#) [AXE812124](#) [AXE816124](#) [AXE720127](#)