

THIS DRAWING IS UNPUBLISHED. RELEASED FOR PUBLICATION  
 © COPYRIGHT copyright.d8te- ALL RIGHTS RESERVED.

REVISIONS				
P	LTR	DESCRIPTION	DATE	APVD
D1		REVISED PER ECR-21-100237	22JAN2021	SK DZ

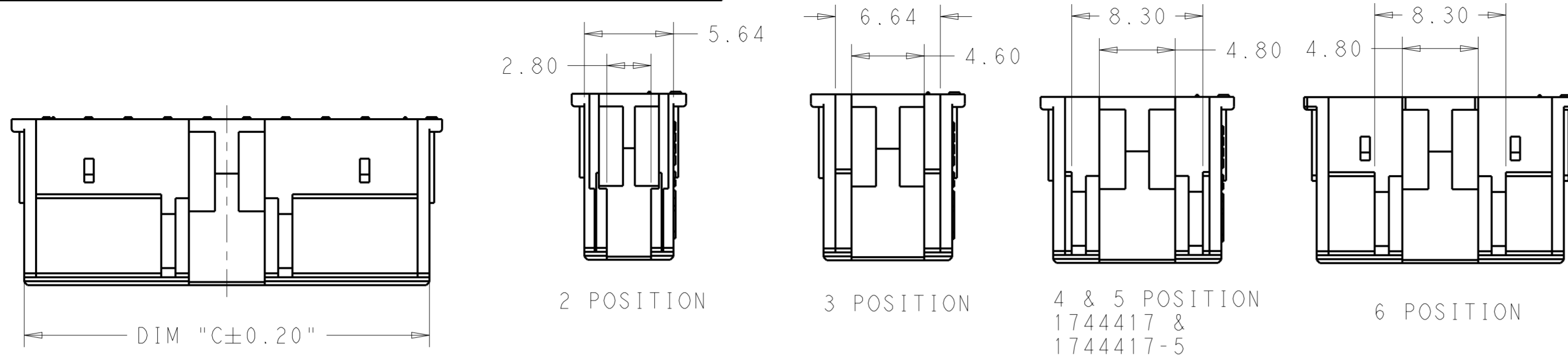

7 THRU 20 POSITION  
 1744417-X

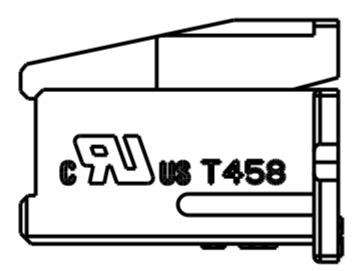
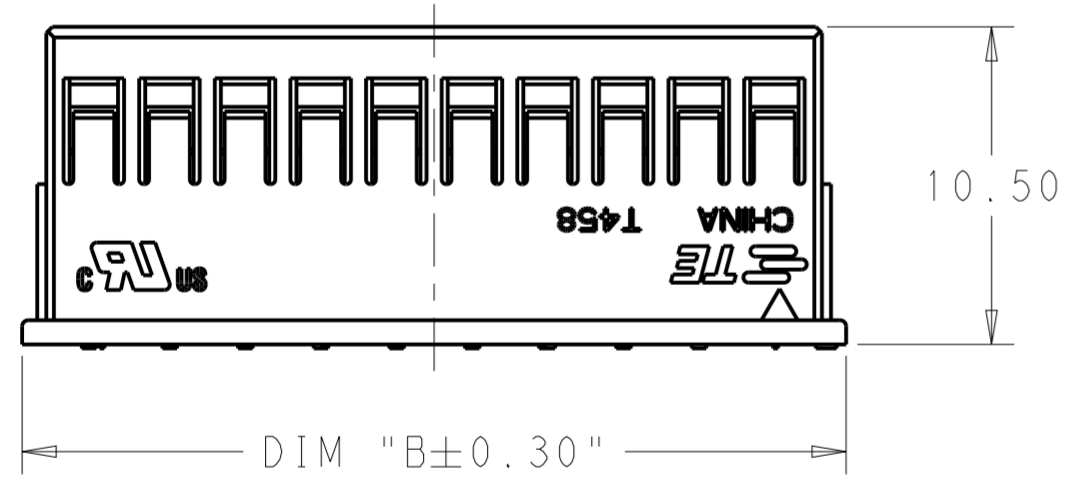
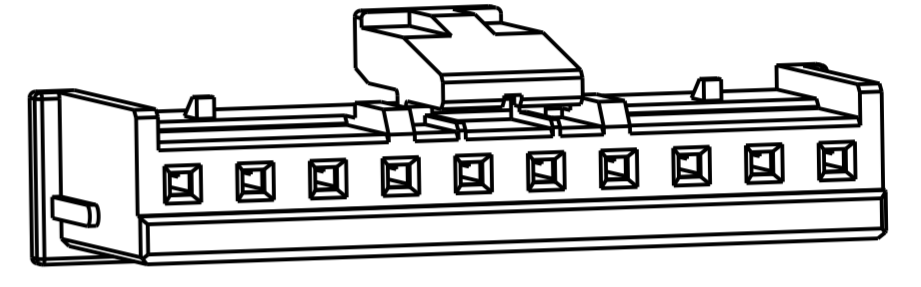
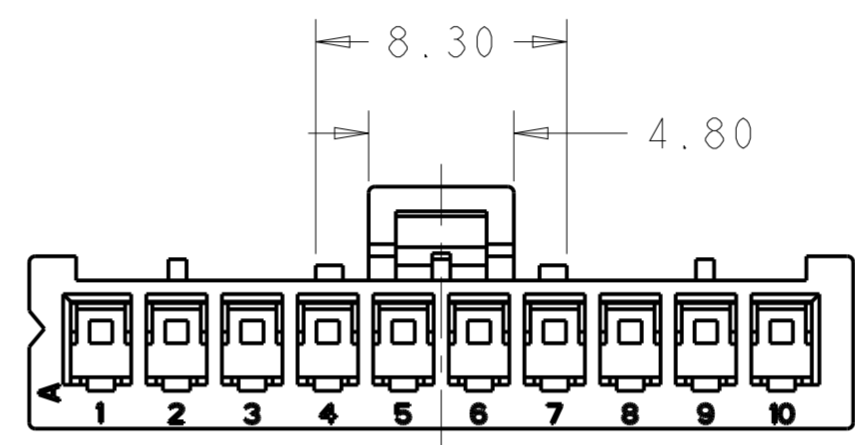
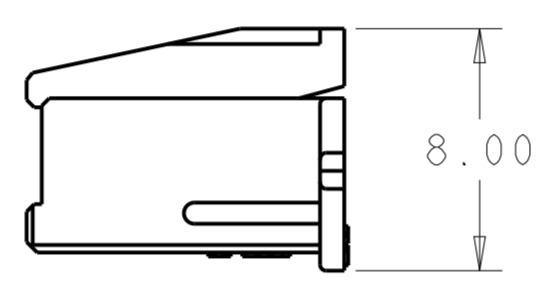
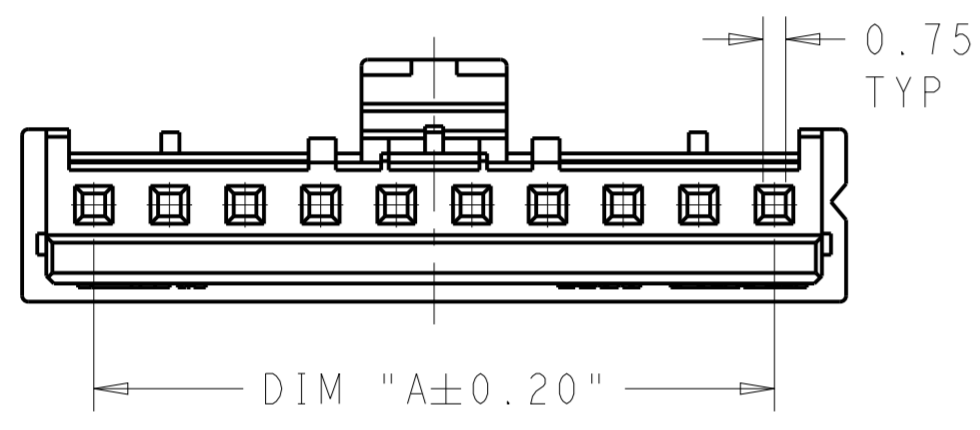

ALTERNATE LOCATION FOR  
 2 AND 3 POSITION PARTS

50.64	52.3	47.5	20	2-1744417-0
48.14	49.8	45.0	19	1-1744417-9
45.64	47.3	42.5	18	1-1744417-8
43.14	44.8	40.0	17	1-1744417-7
40.64	42.3	37.5	16	1-1744417-6
38.14	39.8	35.0	15	1-1744417-5
35.64	37.3	32.5	14	1-1744417-4
33.14	34.8	30.0	13	1-1744417-3
30.64	32.3	27.5	12	1-1744417-2
28.14	29.8	25.0	11	1-1744417-1
25.64	27.3	22.5	10	1-1744417-0
23.14	24.8	20.0	9	1744417-9
20.64	22.3	17.5	8	1744417-8
18.14	19.8	15.0	7	1744417-7
15.64	17.3	12.5	6	1744417-6
13.14	14.8	10.0	5	1744417-5
10.64	12.3	7.5	4	1744417-4
8.14	9.8	5.0	3	1744417-3
5.64	7.3	2.5	2	1744417-2
DIM C	DIM B	DIM A	NO. OF POSITIONS	PART NUMBER

LOCATION FOR  
 4~20 POSITION PARTS

- 1 MATERIAL: NYLON UL94V-0 COLOR: NATURAL
- 2 ACCEPTS TE RECEPTACLE P/N'S 2110989-( )
- 3 THESE HOUSINGS CAN ACCEPT OPTIONAL TPA(RETAINER),P/N ( )-1969443-( ).
- 4 MATES WITH TE HEADER ASSEMBLIES:( )-1744418-( ) & ( )-1744439-( ).
- 5 COMPLY WITH GLOW WIRE REQUIREMENTS FOR PARTS OF NON-METALLIC MATERIAL SUPPORTING A CURRENT-CARRYING CONNECTION DETAILED IN IEC 60335-1, SECTION 30(GWT).

THIS DRAWING IS A CONTROLLED DOCUMENT.

DIMENSIONS: mm	TOLERANCES UNLESS OTHERWISE SPECIFIED: 0 PLC ± 1 PLC ± 2 PLC ±0.25 3 PLC ± 4 PLC ± ANGLES ± FINISH	DWN JR RUTH 23APR15 CHK ASHWINI 23APR15 APVD ASHWINI 23APR15	TE Connectivity NAME ECONOMY POWER 2.5 HOUSING GLOW WIRE
MATERIAL		PRODUCT SPEC APPLICATION SPEC WEIGHT Customer Drawing	

SIZE A2	CAGE CODE -	DRAWING NO. C-1744417	RESTRICTED TO
SCALE 4:1	SHEET 1 OF 1	REV D1	

## X-ON Electronics

Largest Supplier of Electrical and Electronic Components

*Click to view similar products for [Headers & Wire Housings](#) category:*

*Click to view products by [TE Connectivity](#) manufacturer:*

Other Similar products are found below :

[892-18-020-10-001101](#) [58102-G61-06LF](#) [582553-1](#) [0009485154](#) [009176003701906](#) [0050291907](#) [LY20-4P-DT1-P1E-BR](#) [02.125.8002.8](#)  
[609-3404](#) [61062-3](#) [61082-181009](#) [622-3653LF](#) [63453-116](#) [636-1030](#) [636-1427](#) [636-3427](#) [636-4007](#) [641938-9](#) [641991-4](#) [644827-2](#) [65817-](#)  
[010LF](#) [65817-015LF](#) [65863-015LF](#) [66207-023LF](#) [67095-007LF](#) [67601157](#) [68645-018](#) [68648-049](#) [70.362.1628.0](#) [70-4210](#) [70-4226B](#) [70-](#)  
[4853B](#) [707-5020](#) [707-5028](#) [71.350.2428.0](#) [71918-208LF](#) [71961-016LF](#) [733-134](#) [733-162](#) [754199-000](#) [760-3052](#) [787-8014-00](#) [79531-3000](#)  
[FCN-360C032-B](#) [FCN-367T-T012/H](#) [FCN-723D010/2](#) [80.063.4001.1](#) [800-90-001-10-001000](#) [800-90-010-10-002000](#) [801-43-002-10-013000](#)