

LOC J DIST

REVISIONS

変更

P	LTR	DESCRIPTION	DATE	DWN	APVD
D		REVISED PER ECR-15-011723	08AUG2015	Y.O	E.T

ワイヤーレンジ
WIRE RANGE
ID MARK

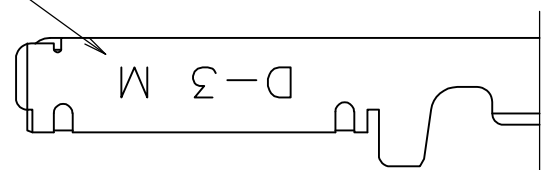

TOOLING ID MARK
ON OUTER SURFACE

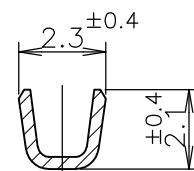

A-A

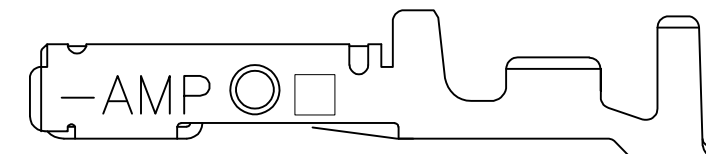
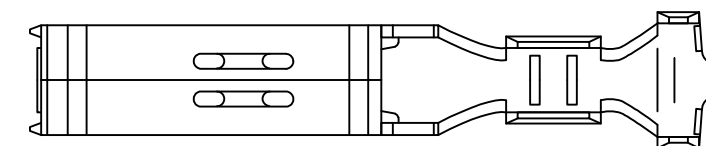

2-5 ONLY

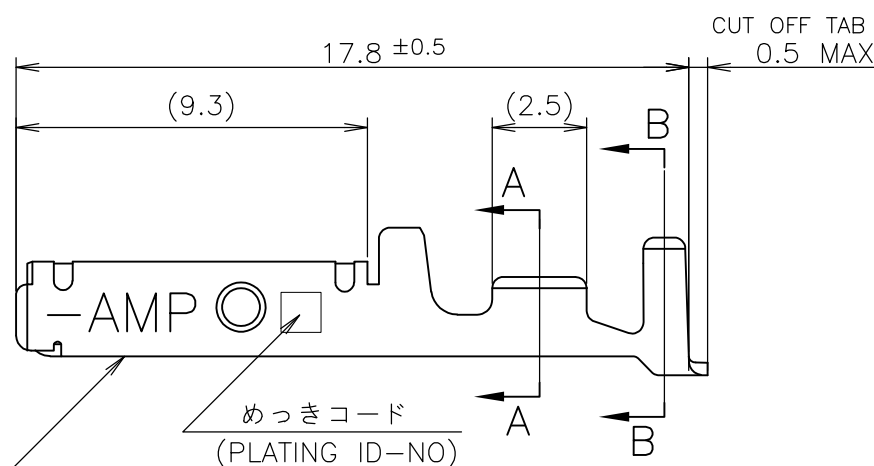
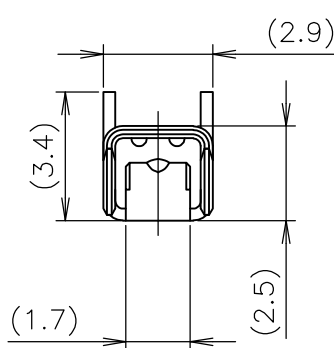

接圧表示
(PRESSURE ID-MARK)

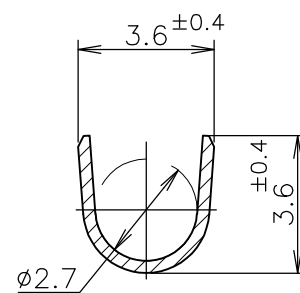

B-B

- ① 標準接圧型コンタクト：一般向け及び多極用
- ② 高接圧型コンタクト：高電流用及び強振動用
- ③ 金めっきは接続部のみとする
- 4 製品規格：108-5349
- 5 取付け適用規格：114-5148

備考 (REMARK)	接圧表示 (ID-MARK)	めっきコード (PL. ID NO)	仕上 (FINISH)	型番 (P/N)	
OBSOLETE	H	5	光沢錫めっき (BRIGHT TIN-PL.)	2-175217-5	
		5	光沢錫めっき (BRIGHT TIN-PL.)	1-175217-5	
		3	0.76μm 最小金めっき (0.76μm MIN. Au-PL.)	1-175217-3	
	①	INACTIVE	2	0.38μm 最小金めっき (0.38μm MIN. Au-PL.)	1-175217-2
			5	光沢錫めっき (BRIGHT TIN-PL.)	175217-5
			3	0.76μm 最小金めっき (0.76μm MIN. Au-PL.)	175217-3
		2	0.38μm 最小金めっき (0.38μm MIN. Au-PL.)	175217-2	

- ① CONTACT TYPE; LOW PRESSURE TYPE (FOR GENERAL)
- ② CONTACT TYPE; HIGH PRESSURE TYPE (FOR HIGH CURRENT OR ANTI-VIBRATION)
- ③ GOLD-PL. CONTACT AREA ONLY
- 4 PRODUCT SPEC: 108-5349
- 5 APPLICATION SPEC: 114-5148

GENERAL TOLERANCE 一般公差
10 ≥ : ±0.2
30 ≥ > 10: ±0.25
100 ≥ > 30: ±0.3
ANGLES: ±3°

THIS DRAWING IS A CONTROLLED DOCUMENT.

DIMENSIONS: 単位: 耗 mm	TOLERANCES UNLESS OTHERWISE SPECIFIED: 一般公差
	0 PLC ± -
	1 PLC ± -
	2 PLC ± -
	3 PLC ± -
	4 PLC ± -
ANGLES ± -	± -
MATERIAL 材料 (COPPER ALLOY) 銅合金	FINISH 仕上 (SEE TABLE) 表参照

DWN	T-YONEBAYASHI	27JUN1990
CHK	H.OBATA	14FEB1991
APVD	S.MANABE	14FEB1991
PRODUCT SPEC	製品規格	
APPLICATION SPEC	取付適用規格	
WEIGHT		
CUSTOMER DRAWING		

WIRE RANGE 包合電線断面積 AWG 24-20 (0.2-0.5mmSQ) mm²		INSULATION DIA 被覆外径 1.2-2.6 mmφ	
STE TE Connectivity			
M SIZE DYNAMIC SERIES REC. CONTACT L/P ダイナミックシリーズリセプタクルコンタクト L/P			
SIZE	CAGE CODE	DRAWING NO 番号	RESTRICTED TO
A3	00779	C-175217	
SCALE 尺度 5:1		SHEET 1 OF 1	REV D

X-ON Electronics

Largest Supplier of Electrical and Electronic Components

Click to view similar products for [Headers & Wire Housings](#) category:

Click to view products by [TE Connectivity](#) manufacturer:

Other Similar products are found below :

[892-18-020-10-001101](#) [58102-G61-06LF](#) [582553-1](#) [0009485154](#) [009176003701906](#) [0050291907](#) [LY20-4P-DT1-P1E-BR](#) [02.125.8002.8](#)
[609-3404](#) [61062-3](#) [61082-181009](#) [622-3653LF](#) [63453-116](#) [636-1030](#) [636-1427](#) [636-3427](#) [636-4007](#) [641938-9](#) [641991-4](#) [644827-2](#) [65817-](#)
[010LF](#) [65817-015LF](#) [65863-015LF](#) [66207-023LF](#) [67095-007LF](#) [67601157](#) [68645-018](#) [68648-049](#) [70.362.1628.0](#) [70-4210](#) [70-4226B](#) [70-](#)
[4853B](#) [707-5020](#) [707-5028](#) [71.350.2428.0](#) [71918-208LF](#) [71961-016LF](#) [733-134](#) [733-162](#) [754199-000](#) [760-3052](#) [787-8014-00](#) [79531-3000](#)
[FCN-360C032-B](#) [FCN-367T-T012/H](#) [FCN-723D010/2](#) [80.063.4001.1](#) [800-90-001-10-001000](#) [800-90-010-10-002000](#) [801-43-002-10-013000](#)