

THIS DRAWING IS UNPUBLISHED.

RELEASED FOR PUBLICATION JUN ,1990.

© COPYRIGHT 1990 By Tyco Electronics Japan G.K.

ALL RIGHTS RESERVED.

LOC J DIST

REVISIONS

変更

DESCRIPTION

DATE

DWN

APVD

P LTR

REVISED PER ECR-15-011723

08AUG2015

Y.O

E.T

ワイヤーレンジ
WIRE RANGE
ID MARK

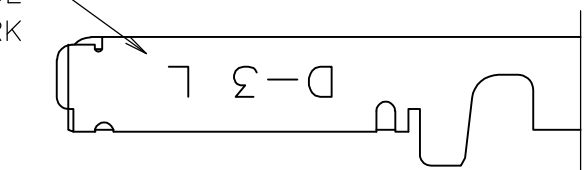

TOOLING ID MARK
ON OUTER SURFACE

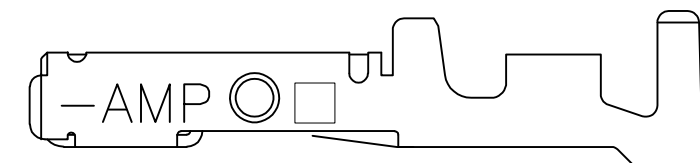
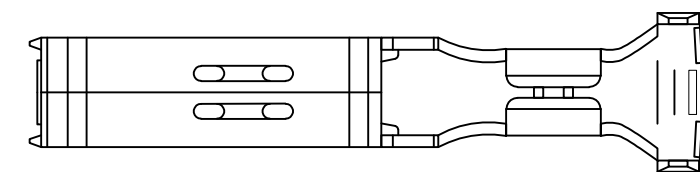
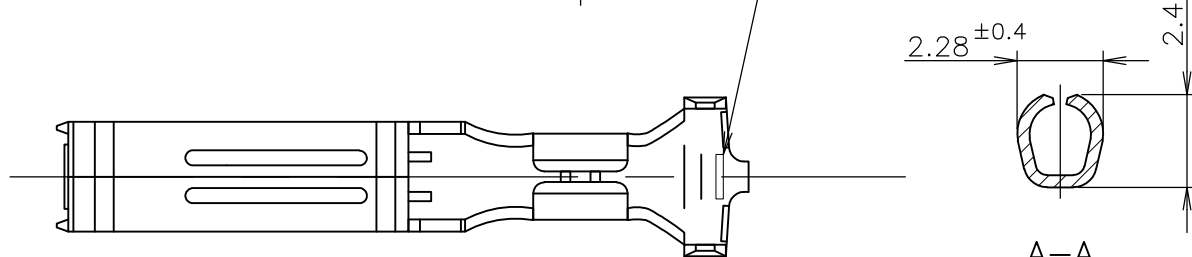

2- -5 ONLY

CUT OFF TAB
0.5 MAX

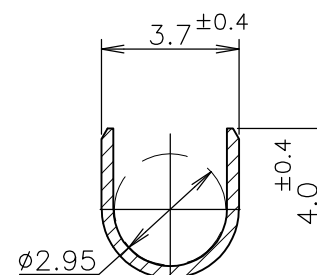
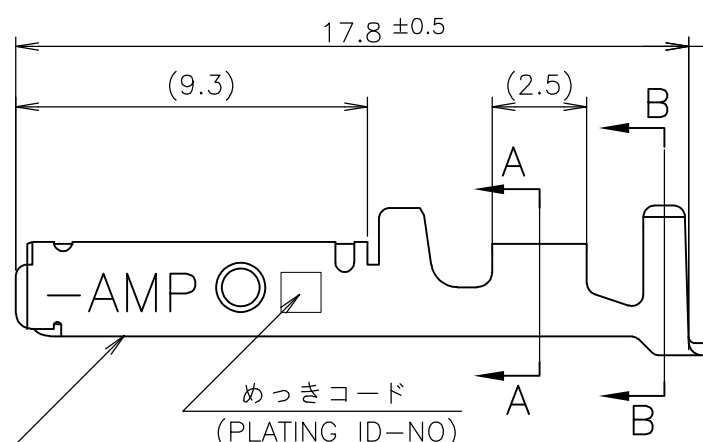

B-B

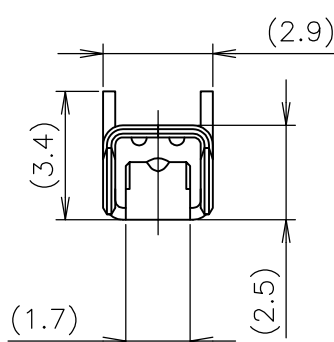

接圧表示
(PRESSURE ID-MARK)

めっきコード
(PLATING ID-NO)

- ① 標準接圧型コンタクト：一般向け及び多極用
- ② 高接圧型コンタクト：高電流用及び強振動用
- ③ 金めっきは接続部のみとする
- 4 製品規格：108-5349
- 5 取付け適用規格：114-5148

OBSOLETE

①	H	5	光沢錫めっき (BRIGHT TIN-PL.)	2-175218-5
		5	光沢錫めっき (BRIGHT TIN-PL.)	1-175218-5
		3	0.76μm 最小金めっき (0.76μm MIN. Au-PL.)	1-175218-3
		2	0.38μm 最小金めっき (0.38μm MIN. Au-PL.)	1-175218-2
		2	0.38μm 最小金めっき (0.38μm MIN. Au-PL.)	175218-2
②	OBSOLETE	5	光沢錫めっき (BRIGHT TIN-PL.)	175218-5
		3	0.76μm 最小金めっき (0.76μm MIN. Au-PL.)	175218-3
		2	0.38μm 最小金めっき (0.38μm MIN. Au-PL.)	175218-2
備考 (REMARK)	接圧表示 (ID-MARK)	めっきコード (PL. ID NO)	仕上 (FINISH)	型番 (P/N)
接点タイプ	(CONT. TYPE)			

- ① CONTACT TYPE; LOW PRESSURE TYPE (FOR GENERAL)
- ② CONTACT TYPE; HIGH PRESSURE TYPE (FOR HIGH CURRENT OR ANTI-VIBRATION)
- ③ GOLD-PL. CONTACT AREA ONLY
- 4 PRODUCT SPEC: 108-5349
- 5 APPLICATION SPEC: 114-5148

GENERAL TOLERANCE 一般公差	
10 ≥ :	±0.2
30 ≥ > 10:	±0.25
100 ≥ > 30:	±0.3
ANGLES:	±3°

THIS DRAWING IS A CONTROLLED DOCUMENT.	
DIMENSIONS: 単位: 耗 mm	TOLERANCES UNLESS OTHERWISE SPECIFIED: 一般公差
0 PLC ±-	1 PLC ±-
2 PLC ±-	3 PLC ±-
4 PLC ±-	ANGLES ±-
MATERIAL 材料 (COPPER ALLOY) 銅合金	FINISH 仕上 (SEE TABLE) 表参照

DWN	27JUN1990
T-YONEBAYASHI	
CHK	14FEB1991
H.OBATA	
APVD	14FEB1991
S.MANABE	
PRODUCT SPEC	製品規格
APPLICATION SPEC	取付適用規格
WEIGHT	
CUSTOMER DRAWING	

WIRE RANGE 包合電線断面積 AWG 20-16 (0.5-1.25mmSQ)mm²		INSULATION DIA 被覆外径 1.8-2.8 mmφ	
STE TE Connectivity			
L SIZE DYNAMIC SERIES REC. CONTACT L/P ダイナミックシリーズリセプタクルコンタクト L/P			
SIZE	CAGE CODE	DRAWING NO 番号	RESTRICTED TO
A3	00779	C-175218	
SCALE 尺度 5:1		SHEET 1 OF 1	REV D

X-ON Electronics

Largest Supplier of Electrical and Electronic Components

Click to view similar products for [Headers & Wire Housings](#) category:

Click to view products by [TE Connectivity](#) manufacturer:

Other Similar products are found below :

[892-18-020-10-001101](#) [58102-G61-06LF](#) [582553-1](#) [0009485154](#) [009176003701906](#) [0050291907](#) [LY20-4P-DT1-P1E-BR](#) [02.125.8002.8](#)
[609-3404](#) [61062-3](#) [61082-181009](#) [622-3653LF](#) [63453-116](#) [636-1030](#) [636-1427](#) [636-3427](#) [636-4007](#) [641938-9](#) [641991-4](#) [644827-2](#) [65817-](#)
[010LF](#) [65817-015LF](#) [65863-015LF](#) [66207-023LF](#) [67095-007LF](#) [67601157](#) [68645-018](#) [68648-049](#) [70.362.1628.0](#) [70-4210](#) [70-4226B](#) [70-](#)
[4853B](#) [707-5020](#) [707-5028](#) [71.350.2428.0](#) [71918-208LF](#) [71961-016LF](#) [733-134](#) [733-162](#) [754199-000](#) [760-3052](#) [787-8014-00](#) [79531-3000](#)
[FCN-360C032-B](#) [FCN-367T-T012/H](#) [FCN-723D010/2](#) [80.063.4001.1](#) [800-90-001-10-001000](#) [800-90-010-10-002000](#) [801-43-002-10-013000](#)